



FLUSH / CONCENTRIC DIFFUSER ASSEMBLY TO SUIT



MODEL: FD9 - 65S

NOTE:

- DIFFUSER HEAD TO BE SUPPORTED INDEPENDENTLY FROM BUILDING STRUCTURE

FEATURES:

- 24GA (G90) GALVANIZED STEEL CONSTRUCTION
- INTERIOR CABINET INSULATED WITH 1" THICK, 1-1/2 lbs/cu ft UL LISTED DUCT LINER
- INTERIOR TRANSITION INSULATED WITH 1/2" THICK, 2 lbs/cu ft UL LISTED DUCT LINER
- COMBINATION SUPPLY/RETURN DIFFUSER WITH FIXED BLADES AND GRID CORE RETURN
- SUPPLY AND RETURN AIR ROUND DUCT COLLARS
- 18" ROUND DUCT CONNECTIONS
- DIFFUSER FACE WHITE POWDER COAT FINISH

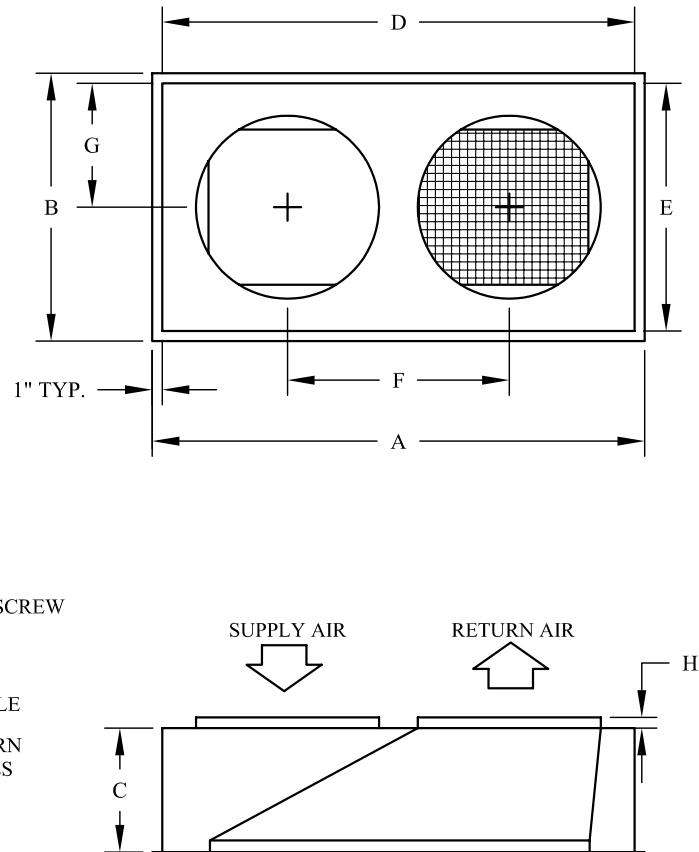
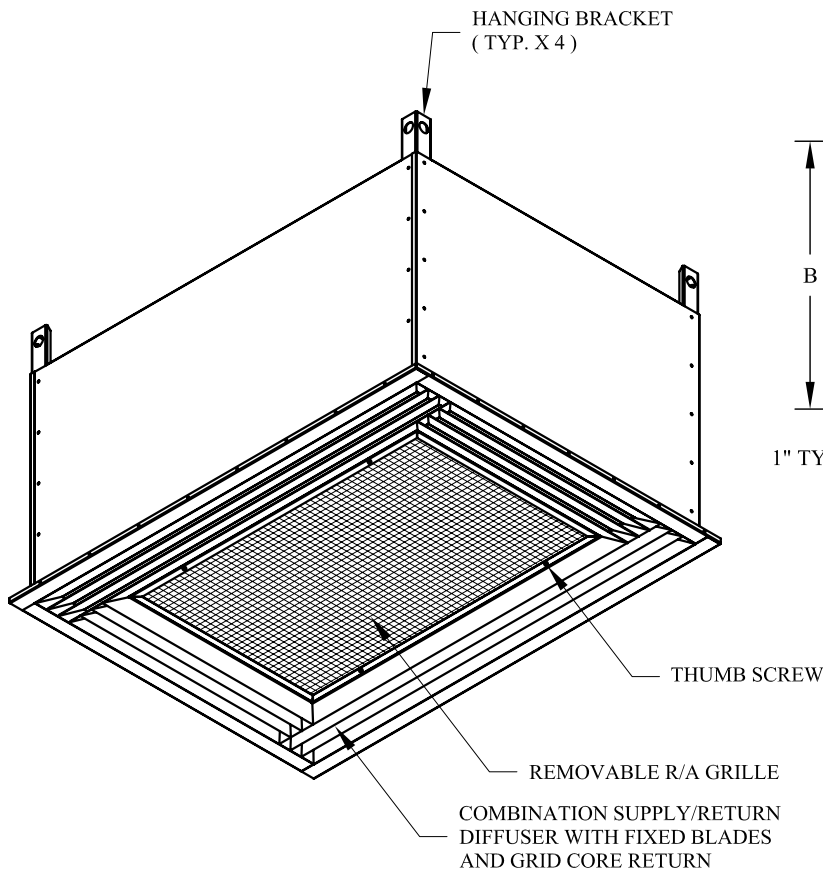

CAT #	CFM RANGE	THROW (RANGE FT)	DIMENSIONAL DATA								SHPG WEIGHT
			A	B	C	D	E	F	G	H	
13K55	800-2200	11-26	47-5/8"	23-5/8"	13-1/2"	45"	21"	22-1/2"	10-1/2"	2"	80 LBS

LFD65
AUG. 17 / 16