



Communicating-ENABLED EL297UHV SERIES UNITS

EL297UHV(X) series units are 90% efficiency gas furnaces used for upflow or horizontal applications only, manufactured with Lennox Duralok heat exchangers formed of aluminized steel. EL297UHV(X) units are available in heating capacities of 44,000 to 132,000 Btuh and cooling applications up to 5 tons. Refer to Product Specifications Manual for proper sizing.

Units are factory equipped for use with natural gas. Kits are available for conversion to LPG operation. EL297UHV(X) model units are equipped with the icomfort[®] enabled SureLight[®] two-stage variable speed integrated control. EL297UHV(X) unit meets the California Nitrogen Oxides (NOx) Standards and California Seasonal Efficiency requirements. All units use a redundant gas valve to assure safety shut-off as required by C.S.A.

All specifications in this manual are subject to change. Procedures outlined in this manual are presented as a recommendation only and do not supersede or replace local or state codes. In the absence of local or state codes, the guidelines and procedures outlined in this manual (except where noted) are recommendations only and do not constitute code.

TABLE OF CONTENTS

Specifications	Page 2
Blower CFM Data	Page 5
I Unit Components	Page 26
II Installation	Page 57
III Start Up	Page 79
IV Heating System Service Checks	Page 80
V Typical Operating Characteristics	Page 83
VI Maintenance	Page 83
VII Wiring and Sequence of Operation	Page 86
Program Unit Capacity Size Mode	Page 110
Troubleshooting	Page 111



⚠ WARNING
 Improper installation, adjustment, alteration, service or maintenance can cause property damage, personal injury or loss of life. Installation and service must be performed by a licensed professional HVAC installer (or equivalent), service agency or the gas supplier.

⚠ CAUTION
 As with any mechanical equipment, contact with sharp sheet metal edges can result in personal injury. Take care while handling this equipment and wear gloves and protective clothing.

SPECIFICATIONS

Gas	Model No.	EL297UH045XV36B	EL297UH070XV36B	EL297UH090XV36C
Heating Performance	¹ AFUE	97%	97%	97%
High Fire	Input - Btuh	44,000	66,000	88,000
	Output - Btuh	43,000	64,000	85,000
	Temperature rise range - °F	35 - 65	50 - 80	60 - 90
	Gas Manifold Pressure (in. w.g.)	3.5 / 10.0	3.5 / 10.0	3.5 / 10.0
	Nat. Gas / LPG/Propane			
Low Fire	Input - Btuh	29,000	43,000	57,000
	Output - Btuh	28,000	42,000	56,000
	Temperature rise range - °F	20 - 50	25 - 55	30 - 60
	Gas Manifold Pressure (in. w.g.)	1.7 / 4.5	1.7 / 4.5	1.7 / 4.5
	Nat. Gas / LPG/Propane			
High static - in. w.g.	Heating	0.8	0.8	0.8
	Cooling	1.0	1.0	1.0
Connections in.	Intake / Exhaust Pipe (PVC)	2 / 2	2 / 2	2 / 2
	Gas pipe size IPS	1/2	1/2	1/2
	Condensate Drain Trap (PVC pipe) - i.d.	3/4	3/4	3/4
	with furnished 90° street elbow	3/4 slip x 3/4 Mipt	3/4 slip x 3/4 Mipt	3/4 slip x 3/4 Mipt
	with field supplied (PVC coupling) - o.d.	3/4 slip x 3/4 MPT	3/4 slip x 3/4 MPT	3/4 slip x 3/4 MPT
Indoor Blower	Wheel nominal diameter x width - in.	10 x 9	10 x 9	10 x 9
	Motor output - hp	1/2	1/2	1/2
	Tons of add-on cooling	2 - 3	2 - 3	2 - 3
	Air Volume Range - cfm	465 - 1370	490 - 1365	520 - 1360
Electrical Data	Voltage	120 volts - 60 hertz - 1 phase		
	Blower motor full load amps	7.7	7.7	7.7
	Maximum overcurrent protection	15	15	15
Shipping Data	lbs. - 1 package	130	136	152

NOTE - Filters and provisions for mounting are not furnished and must be field provided.

¹ Annual Fuel Utilization Efficiency based on DOE test procedures and according to FTC labeling regulations. Isolated combustion system rating for non-weatherized furnaces.

SPECIFICATIONS

Gas	Model No.	EL297UH090XV48C	EL297UH090XV60C	EL297UH110XV48C
Heating Performance	AHRI Ref. No.	4988513	4988514	4988515
	¹ AFUE	97%	97%	97%
High Fire	Input - Btuh	88,000	88,000	110,000
	Output - Btuh	86,000	86,000	106,000
	Temperature rise range - °F	45 - 75	40 - 70	60 - 90
	Gas Manifold Pressure (in. w.g.)	3.5 / 10.0	3.5 / 10.0	3.5 / 10.0
	Nat. Gas / LPG/Propane			
Low Fire	Input - Btuh	57,000	57,000	72,000
	Output - Btuh	56,000	56,000	70,000
	Temperature rise range - °F	30 - 60	25 - 55	35 - 65
	Gas Manifold Pressure (in. w.g.)	1.7 / 4.5	1.7 / 4.5	1.7 / 4.5
	Nat. Gas / LPG/Propane			
High static - in. w.g.	Heating	0.8	0.8	0.8
	Cooling	1.0	1.0	1.0
Connections in.	Intake / Exhaust Pipe (PVC)	2 / 2	2 / 2	2 / 2
	Gas pipe size IPS	1/2	1/2	1/2
	Condensate Drain Trap (PVC pipe) - i.d.	3/4	3/4	3/4
	with furnished 90° street elbow	3/4 slip x 3/4 Mipt	3/4 slip x 3/4 Mipt	3/4 slip x 3/4 Mipt
	with field supplied (PVC coupling) - o.d.	3/4 slip x 3/4 MPT	3/4 slip x 3/4 MPT	3/4 slip x 3/4 MPT
Indoor Blower	Wheel nominal diameter x width - in.	11 x 11	11 x 11	11 x 11
	Motor output - hp	3/4	1	3/4
	Tons of add-on cooling	2.5 - 4	3 - 5	2.5 - 4
	Air Volume Range - cfm	680 - 1770	840 - 2195	670 - 1760
Electrical Data	Voltage	120 volts - 60 hertz - 1 phase		
	Blower motor full load amps	10.1	12.8	10.1
	Maximum overcurrent protection	15	20	15
Shipping Data	lbs. - 1 package	163	164	173

NOTE - Filters and provisions for mounting are not furnished and must be field provided.

¹ Annual Fuel Utilization Efficiency based on DOE test procedures and according to FTC labeling regulations. Isolated combustion system rating for non-weatherized furnaces.

SPECIFICATIONS

	Model No.	EL297UH110XV60C	EL297UH135XV60D	
Gas Heating Performance	¹ AFUE	97%	97%	
	High Fire	Input - Btuh	110,000	132,000
		Output - Btuh	107,000	127,000
	Temperature rise range - °F	45 - 75	55 - 85	
	Gas Manifold Pressure (in. w.g.) Nat. Gas / LPG/Propane	3.5 / 10.0	3.5 / 10.0	
	Low Fire	Input - Btuh	72,000	86,000
		Output - Btuh	70,000	84,000
		Temperature rise range - °F	35 - 65	40 - 70
		Gas Manifold Pressure (in. w.g.) Nat. Gas / LPG/Propane	1.7 / 4.5	1.7 / 4.5
	High static - in. w.g.	Heating	0.8	0.8
Cooling		1.0	1.0	
Connections in.	Intake / Exhaust Pipe (PVC)	2 / 2	2 / 2	
	Gas pipe size IPS	1/2	1/2	
	Condensate Drain Trap (PVC pipe) - i.d.	3/4	3/4	
	with furnished 90° street elbow	3/4 slip x 3/4 Mipt	3/4 slip x 3/4 Mipt	
	with field supplied (PVC coupling) - o.d.	3/4 slip x 3/4 MPT	3/4 slip x 3/4 MPT	
Indoor Blower	Wheel nominal diameter x width - in.	11 x 11	11 x 11	
	Motor output - hp	1	1	
	Tons of add-on cooling	3-5	3-5	
	Air Volume Range - cfm	850 - 2125	950 - 2250	
Electrical Data	Voltage	120 volts - 60 hertz - 1 phase		
	Blower motor full load amps	12.8	12.8	
	Maximum overcurrent protection	20	20	
Shipping Data	lbs. - 1 package	174	188	

NOTE - Filters and provisions for mounting are not furnished and must be field provided.

¹ Annual Fuel Utilization Efficiency based on DOE test procedures and according to FTC labeling regulations. Isolated combustion system rating for non-weatherized furnaces.

BLOWER DATA

EL297UH045XV36B BLOWER PERFORMANCE (less filter)

BOTTOM RETURN AIR

0 through 0.8 in. w.g. (Heating) and 0 through 1.0 in. w.g. (Cooling) External Static Pressure Range

HEATING		
¹ Heating Speed DIP Switch Settings	First Stage Heating Speed - cfm	Second Stage Heating Speed - cfm
+24%	915	1125
+18%	865	1085
+12%	805	1040
+6%	780	985
Factory Default	740	925
-6%	665	875
-12%	630	800
-18%	585	735

COOLING								
¹ Cooling Speed DIP Switch Settings	First Stage Cooling Speed - cfm				Second Stage Cooling Speed - cfm			
	Low	Medium-Low	Medium-High	² High	Low	Medium-Low	Medium-High	² High
+	595	760	865	980	905	1075	1210	1370
Factory Default	540	660	785	890	815	980	1120	1255
-	485	600	695	790	720	885	1020	1135

¹ Cooling and heating speeds are based on a combination of DIP switch settings on the furnace control. Refer to Installation Instructions for specific DIP Switch Settings.

² Factory default setting.

NOTES - The effect of static pressure is included in air volumes shown.

First stage HEAT is approximately 91% of the same second stage HEAT.

First stage COOL (two-stage air conditioning units only) is approximately 70% of the same second stage COOL speed position.

Continuous Fan Only speed is selectable at 28% and 38% of the selected second stage cooling speed - minimum 250 cfm.

Lennox® Smart Zoning System Applications - Minimum blower speed is 250 cfm.

EL297UH045XV36B BLOWER MOTOR WATTS (COOLING)

¹ Cooling Speed DIP Switch Settings	Motor Watts @ Various External Static Pressures - in. wg.																				
	First Stage										Second Stage										
	0	0.1	0.2	0.3	0.4	0.5	0.6	0.7	0.8	0	0.1	0.2	0.3	0.4	0.5	0.6	0.7	0.8	0.9	1.0	
+ Setting																					
Cooling Speed	Low	18	33	54	73	88	107	124	144	158	64	87	112	140	171	196	225	243	267	297	317
	Med-low	36	58	82	100	120	141	166	182	211	127	138	185	214	237	271	296	326	348	369	390
	Med-High	57	86	103	128	159	187	210	233	255	189	219	250	280	305	340	377	411	439	464	483
	High	91	114	142	177	217	235	259	285	311	267	281	322	363	400	433	468	502	521	552	549
Factory Default																					
Cooling Speed	Low	16	34	52	67	86	98	120	138	155	46	69	91	115	142	167	188	206	232	260	280
	Med-low	25	35	65	85	110	125	140	155	180	93	110	138	173	209	230	255	280	304	325	343
	Med-High	41	66	87	106	129	154	178	195	223	150	166	206	238	264	293	320	349	376	399	420
	High	61	87	110	138	169	194	222	241	265	213	245	269	300	334	368	399	431	460	480	513
- Setting																					
Cooling Speed	Low	10	28	40	56	76	89	106	122	137	33	52	78	97	116	132	159	174	202	224	238
	Med-low	18	34	55	73	89	108	124	145	159	59	86	104	129	160	187	211	234	256	282	303
	Med-High	29	45	72	92	114	129	151	166	193	107	122	157	188	221	247	273	302	324	343	361
	High	44	67	89	111	135	160	183	200	227	160	185	214	246	277	302	335	364	391	414	435

BLOWER DATA

EL297UH045XV36B BLOWER PERFORMANCE (less filter)

SINGLE SIDE RETURN AIR

0 through 0.8 in. w.g. (Heating) and 0 through 1.0 in. w.g. (Cooling) External Static Pressure Range

HEATING

¹ Heating Speed DIP Switch Settings	First Stage Heating Speed - cfm	Second Stage Heating Speed - cfm
+24%	910	1125
+18%	850	1080
+12%	785	1035
+6%	765	990
Factory Default	755	935
-6%	690	880
-12%	635	810
-18%	600	765

COOLING

¹ Cooling Speed DIP Switch Settings	First Stage Cooling Speed - cfm				Second Stage Cooling Speed - cfm			
	Low	Medium-Low	Medium-High	² High	Low	Medium-Low	Medium-High	² High
+	610	760	845	975	920	1065	1205	1340
Factory Default	550	680	770	880	815	985	1110	1245
-	465	610	720	775	745	890	1020	1130

¹ Cooling and heating speeds are based on a combination of DIP switch settings on the furnace control. Refer to Installation Instructions for specific DIP Switch Settings.

² Factory default setting.

NOTES - The effect of static pressure is included in air volumes shown.

First stage HEAT is approximately 91% of the same second stage HEAT.

First stage COOL (two-stage air conditioning units only) is approximately 70% of the same second stage COOL speed position.

Continuous Fan Only speed is selectable at 28% and 38% of the selected second stage cooling speed - minimum 250 cfm.

Lennox® Smart Zoning System Applications - Minimum blower speed is 250 cfm.

EL297UH045XV36B BLOWER MOTOR WATTS (COOLING)

¹ Cooling Speed DIP Switch Settings	Motor Watts @ Various External Static Pressures - in. w.g.																				
	First Stage										Second Stage										
	0	0.1	0.2	0.3	0.4	0.5	0.6	0.7	0.8	0	0.1	0.2	0.3	0.4	0.5	0.6	0.7	0.8	0.9	1.0	
+ Setting																					
Cooling Speed	Low	19	37	57	74	97	116	136	151	168	55	82	104	135	158	194	221	243	270	297	314
	Med-low	34	57	80	103	124	148	168	195	216	103	123	159	193	225	254	282	307	338	361	389
	Med-High	45	74	98	123	150	179	204	236	260	164	198	225	260	287	326	352	391	428	450	478
	High	76	103	133	163	191	223	256	277	303	235	256	294	346	374	409	445	478	510	541	551
Factory Default																					
Cooling Speed	Low	16	31	52	67	85	100	118	136	150	38	68	90	106	133	162	188	212	239	262	286
	Med-low	20	45	65	85	110	125	145	170	195	75	99	128	159	187	219	251	273	299	323	350
	Med-High	38	64	88	106	130	157	180	207	230	125	145	186	216	248	278	303	331	365	388	419
	High	51	81	103	133	157	191	218	242	268	182	210	245	273	317	346	376	410	440	465	497
- Setting																					
Cooling Speed	Low	10	28	40	59	73	89	105	121	138	30	52	72	100	119	141	159	185	206	228	253
	Med-low	20	38	58	75	97	116	136	151	169	48	75	99	124	151	180	205	237	261	285	303
	Med-High	27	48	69	93	116	133	152	178	203	85	107	139	172	201	233	266	286	312	337	364
	High	38	66	89	106	131	159	184	209	235	134	155	196	223	259	290	316	344	374	399	432

BLOWER DATA

EL297UH045XV36B BLOWER PERFORMANCE (less filter)

SINGLE SIDE RETURN AIR WITH OPTIONAL RETURN AIR BASE

0 through 0.8 in. w.g. (Heating) and 0 through 1.0 in. w.g. (Cooling) External Static Pressure Range

HEATING

¹ Heating Speed DIP Switch Settings	First Stage Heating Speed - cfm	Second Stage Heating Speed - cfm
+24%	895	1115
+18%	850	1070
+12%	795	1030
+6%	755	980
Factory Default	715	920
-6%	665	850
-12%	645	805
-18%	595	740

COOLING

¹ Cooling Speed DIP Switch Settings	First Stage Cooling Speed - cfm				Second Stage Cooling Speed - cfm			
	Low	Medium-Low	Medium-High	² High	Low	Medium-Low	Medium-High	² High
+	605	730	845	965	895	1060	1185	1345
Factory Default	550	660	760	875	820	975	1105	1215
-	490	610	685	770	720	860	1015	1125

¹ Cooling and heating speeds are based on a combination of DIP switch settings on the furnace control. Refer to Installation Instructions for specific DIP Switch Settings.

² Factory default setting.

NOTES - The effect of static pressure is included in air volumes shown.

First stage HEAT is approximately 91% of the same second stage HEAT.

First stage COOL (two-stage air conditioning units only) is approximately 70% of the same second stage COOL speed position.

Continuous Fan Only speed is selectable at 28% and 38% of the selected second stage cooling speed - minimum 250 cfm.

Lennox® Smart Zoning System Applications - Minimum blower speed is 250 cfm.

EL297UH045XV36B BLOWER MOTOR WATTS (COOLING)

¹ Cooling Speed DIP Switch Settings	Motor Watts @ Various External Static Pressures - in. wg.																				
	First Stage										Second Stage										
	0	0.1	0.2	0.3	0.4	0.5	0.6	0.7	0.8	0	0.1	0.2	0.3	0.4	0.5	0.6	0.7	0.8	0.9	1.0	
+ Setting																					
Cooling Speed	Low	20	36	57	77	99	111	133	149	168	54	82	99	130	157	180	210	238	259	282	308
	Med-low	28	50	72	97	118	141	161	184	207	103	122	159	189	220	250	277	303	331	353	382
	Med-High	45	74	94	121	148	170	201	221	254	162	188	227	259	283	318	353	383	414	435	473
	High	73	98	130	157	186	219	247	274	294	224	249	283	326	366	398	433	473	491	529	545
Factory Default																					
Cooling Speed	Low	14	32	47	62	82	100	119	132	149	38	63	82	109	131	161	176	210	231	250	272
	Med-low	20	40	60	80	105	120	145	160	180	74	96	125	152	182	214	242	268	289	313	335
	Med-High	31	57	76	104	126	153	170	196	223	123	143	180	215	240	272	300	326	359	379	408
	High	51	81	98	128	156	178	208	235	258	173	206	240	261	297	337	365	402	431	456	490
- Setting																					
Cooling Speed	Low	8	27	38	54	73	88	106	119	137	27	46	71	92	112	133	155	178	195	214	242
	Med-low	21	37	57	77	100	112	134	149	169	48	75	95	122	149	171	201	222	255	271	294
	Med-High	25	44	67	86	110	127	150	170	187	84	105	139	167	197	229	256	284	305	330	355
	High	34	60	79	106	128	157	173	203	227	130	153	188	225	248	282	307	339	371	392	420

BLOWER DATA

EL297UH070XV36B BLOWER PERFORMANCE (less filter)

BOTTOM RETURN AIR

0 through 0.8 in. w.g. (Heating) and 0 through 1.0 in. w.g. (Cooling) External Static Pressure Range

HEATING

¹ Heating Speed DIP Switch Settings	First Stage Heating Speed - cfm				Second Stage Heating Speed - cfm			
	+24%	1095				1220		
+18%	1035				1170			
+12%	985				1120			
+6%	915				1055			
Factory Default	850				995			
-6%	835				915			
-12%	755				845			
-18%	695				810			

COOLING

¹ Cooling Speed DIP Switch Settings	First Stage Cooling Speed - cfm				Second Stage Cooling Speed - cfm			
	Low	Medium-Low	Medium-High	² High	Low	Medium-Low	Medium-High	² High
+	600	740	840	970	860	1060	1215	1365
Factory Default	555	665	770	855	810	960	1130	1265
-	500	600	680	790	705	840	1005	1140

¹ Cooling and heating speeds are based on a combination of DIP switch settings on the furnace control. Refer to Installation Instructions for specific DIP Switch Settings.

² Factory default setting.

NOTES - The effect of static pressure is included in air volumes shown.

First stage HEAT is approximately 91% of the same second stage HEAT.

First stage COOL (two-stage air conditioning units only) is approximately 70% of the same second stage COOL speed position.

Continuous Fan Only speed is selectable at 28% and 38% of the selected second stage cooling speed - minimum 250 cfm.

Lennox® Smart Zoning System Applications - Minimum blower speed is 250 cfm.

EL297UH070XV36B BLOWER MOTOR WATTS (COOLING)

¹ Cooling Speed DIP Switch Settings	Motor Watts @ Various External Static Pressures - in. w.g.																				
	First Stage										Second Stage										
	0	0.1	0.2	0.3	0.4	0.5	0.6	0.7	0.8	0	0.1	0.2	0.3	0.4	0.5	0.6	0.7	0.8	0.9	1.0	
+ Setting																					
Cooling Speed	Low	22	36	51	60	80	95	101	117	138	68	88	105	129	152	169	198	214	231	244	274
	Med-low	37	57	75	89	106	127	148	168	182	121	144	168	192	211	243	262	287	305	329	358
	Med-High	62	85	97	122	144	164	180	203	220	213	231	259	285	311	328	357	374	397	419	445
	High	88	115	132	155	176	203	233	240	274	304	322	359	379	411	442	458	486	502	527	554
Factory Default																					
Cooling Speed	Low	16	29	42	55	71	82	98	112	120	52	69	86	107	122	146	165	183	199	212	229
	Med-low	26	41	63	79	88	112	128	145	159	89	108	135	151	174	198	223	247	268	288	298
	Med-High	39	62	77	96	117	140	156	180	196	151	173	201	225	243	266	289	313	339	368	383
	High	65	84	104	125	148	166	178	206	225	237	256	284	303	328	343	374	395	421	435	454
- Setting																					
Cooling Speed	Low	11	21	35	53	64	75	82	95	113	34	50	67	86	106	121	141	159	174	186	201
	Med-low	21	36	51	66	81	92	107	127	141	64	85	100	114	145	160	182	206	219	237	251
	Med-High	35	48	66	82	104	118	137	146	159	101	125	143	171	193	211	242	258	282	304	330
	High	43	60	82	100	123	144	159	174	197	161	188	211	229	258	277	307	327	354	379	404

BLOWER DATA

EL297UH070XV36B BLOWER PERFORMANCE (less filter)

SINGLE SIDE RETURN AIR

0 through 0.8 in. w.g. (Heating) and 0 through 1.0 in. w.g. (Cooling) External Static Pressure Range

HEATING

¹ Heating Speed DIP Switch Settings	First Stage Heating Speed - cfm	Second Stage Heating Speed - cfm
+24%	1090	1205
+18%	1025	1165
+12%	960	1090
+6%	890	1045
Factory Default	815	975
-6%	755	895
-12%	720	810
-18%	675	750

COOLING

¹ Cooling Speed DIP Switch Settings	First Stage Cooling Speed - cfm				Second Stage Cooling Speed - cfm			
	Low	Medium-Low	Medium-High	² High	Low	Medium-Low	Medium-High	² High
+	590	705	805	955	840	1050	1205	1355
Factory Default	540	640	725	820	750	945	1130	1230
-	500	580	665	720	685	805	990	1110

¹ Cooling and heating speeds are based on a combination of DIP switch settings on the furnace control. Refer to Installation Instructions for specific DIP Switch Settings.

² Factory default setting.

NOTES - The effect of static pressure is included in air volumes shown.

First stage HEAT is approximately 91% of the same second stage HEAT.

First stage COOL (two-stage air conditioning units only) is approximately 70% of the same second stage COOL speed position.

Continuous Fan Only speed is selectable at 28% and 38% of the selected second stage cooling speed - minimum 250 cfm.

Lennox® Smart Zoning System Applications - Minimum blower speed is 250 cfm.

EL297UH070XV36B BLOWER MOTOR WATTS (COOLING)

¹ Cooling Speed DIP Switch Settings	Motor Watts @ Various External Static Pressures - in. wg.																				
	First Stage										Second Stage										
	0	0.1	0.2	0.3	0.4	0.5	0.6	0.7	0.8	0	0.1	0.2	0.3	0.4	0.5	0.6	0.7	0.8	0.9	1.0	
+ Setting																					
Cooling Speed	Low	17	29	48	61	73	94	100	123	130	63	84	104	117	142	160	174	208	215	245	255
	Med-low	30	50	66	79	107	128	137	159	178	121	137	165	195	213	239	257	283	303	329	342
	Med-High	51	70	92	106	127	150	170	184	207	195	214	243	268	290	324	348	370	387	409	434
	High	88	109	134	150	184	201	221	243	265	294	309	344	372	399	421	445	474	495	520	532
Factory Default																					
Cooling Speed	Low	12	25	38	52	66	83	96	105	117	43	65	75	98	120	139	152	170	192	212	228
	Med-low	22	41	55	70	86	103	123	141	154	88	106	130	150	173	197	220	239	259	276	297
	Med-High	36	55	75	90	107	129	152	167	184	142	161	187	211	239	263	287	307	332	352	369
	High	57	76	99	116	135	153	176	197	213	220	236	267	294	323	342	364	382	411	436	455
- Setting																					
Cooling Speed	Low	8	22	32	50	60	77	86	100	116	31	48	63	83	102	122	137	150	166	188	203
	Med-low	19	32	47	63	77	93	103	120	133	53	75	91	111	129	152	169	188	210	227	251
	Med-High	25	42	58	74	90	109	131	143	154	101	120	141	170	190	215	233	256	274	298	317
	High	37	56	76	95	115	135	153	173	192	157	177	201	224	254	277	303	321	346	362	385

BLOWER DATA

EL297UH070XV36B BLOWER PERFORMANCE (less filter)

SINGLE SIDE RETURN AIR WITH OPTIONAL RETURN AIR BASE

0 through 0.8 in. w.g. (Heating) and 0 through 1.0 in. w.g. (Cooling) External Static Pressure Range

HEATING

¹ Heating Speed DIP Switch Settings	First Stage Heating Speed - cfm		Second Stage Heating Speed - cfm	
	+24%	1070		1205
+18%	1020		1150	
+12%	955		1100	
+6%	895		1035	
Factory Default	850		965	
-6%	795		905	
-12%	745		845	
-18%	690		790	

COOLING

¹ Cooling Speed DIP Switch Settings	First Stage Cooling Speed - cfm				Second Stage Cooling Speed - cfm			
	Low	Medium-Low	Medium-High	² High	Low	Medium-Low	Medium-High	² High
+	595	715	815	950	855	1045	1205	1350
Factory Default	520	655	755	840	790	945	1090	1255
-	490	595	670	745	720	845	985	1130

¹ Cooling and heating speeds are based on a combination of DIP switch settings on the furnace control. Refer to Installation Instructions for specific DIP Switch Settings.

² Factory default setting.

NOTES - The effect of static pressure is included in air volumes shown.

First stage HEAT is approximately 91% of the same second stage HEAT.

First stage COOL (two-stage air conditioning units only) is approximately 70% of the same second stage COOL speed position.

Continuous Fan Only speed is selectable at 28% and 38% of the selected second stage cooling speed - minimum 250 cfm.

Lennox® Smart Zoning System Applications - Minimum blower speed is 250 cfm.

EL297UH070XV36B BLOWER MOTOR WATTS (COOLING)

¹ Cooling Speed DIP Switch Settings	Motor Watts @ Various External Static Pressures - in. wg.																				
	First Stage										Second Stage										
	0	0.1	0.2	0.3	0.4	0.5	0.6	0.7	0.8	0	0.1	0.2	0.3	0.4	0.5	0.6	0.7	0.8	0.9	1.0	
+ Setting																					
Cooling Speed	Low	18	32	46	61	76	89	104	115	133	64	83	95	120	141	159	175	203	208	234	246
	Med-low	34	52	69	86	104	126	141	160	174	109	131	150	179	204	219	239	268	283	313	335
	Med-High	63	82	98	115	138	153	173	187	209	177	197	227	246	273	311	328	354	383	402	408
	High	88	107	131	148	175	192	217	235	253	261	281	312	346	382	402	430	465	489	506	533
Factory Default																					
Cooling Speed	Low	12	25	37	55	66	82	94	105	121	43	61	76	99	121	133	162	169	189	211	224
	Med-low	25	40	55	74	89	109	120	136	150	76	96	112	138	162	186	207	232	243	262	281
	Med-High	41	61	75	98	115	135	151	173	189	129	150	177	198	227	247	272	301	324	332	369
	High	63	86	99	122	139	159	180	204	216	209	227	254	282	298	324	341	364	395	413	428
- Setting																					
Cooling Speed	Low	9	20	35	48	59	75	86	94	110	29	43	63	84	99	113	131	144	164	185	197
	Med-low	16	32	45	62	75	90	103	119	138	56	71	101	112	131	158	168	184	207	235	245
	Med-High	28	43	63	77	98	115	132	145	162	88	107	129	154	183	204	214	245	263	281	308
	High	46	61	86	100	121	136	153	172	193	142	163	187	216	236	261	279	301	325	356	375

BLOWER DATA

EL297UH090XV36C BLOWER PERFORMANCE (less filter)

BOTTOM RETURN AIR

0 through 0.8 in. w.g. (Heating) and 0 through 1.0 in. w.g. (Cooling) External Static Pressure Range

HEATING		
¹ Heating Speed DIP Switch Settings	First Stage Heating Speed - cfm	Second Stage Heating Speed - cfm
+24%	1215	1300
+18%	1140	1240
+12%	1100	1170
+6%	1020	1115
Factory Default	965	1070
-6%	915	970
-12%	850	925
-18%	805	855

COOLING								
¹ Cooling Speed DIP Switch Settings	First Stage Cooling Speed - cfm				Second Stage Cooling Speed - cfm			
	Low	Medium-Low	Medium-High	² High	Low	Medium-Low	Medium-High	² High
+	625	710	830	950	875	1040	1210	1360
Factory Default	565	670	760	860	800	945	1100	1245
-	520	610	685	785	720	840	970	1115

¹ Cooling and heating speeds are based on a combination of DIP switch settings on the furnace control. Refer to Installation Instructions for specific DIP Switch Settings.

² Factory default setting.

NOTES - The effect of static pressure is included in air volumes shown.

First stage HEAT is approximately 91% of the same second stage HEAT.

First stage COOL (two-stage air conditioning units only) is approximately 70% of the same second stage COOL speed position.

Continuous Fan Only speed is selectable at 28% and 38% of the selected second stage cooling speed - minimum 250 cfm.

Lennox® Smart Zoning System Applications - Minimum blower speed is 250 cfm.

EL297UH090XV36C BLOWER MOTOR WATTS (COOLING)

¹ Cooling Speed DIP Switch Settings	Motor Watts @ Various External Static Pressures - in. wg.																				
	First Stage										Second Stage										
	0	0.1	0.2	0.3	0.4	0.5	0.6	0.7	0.8	0	0.1	0.2	0.3	0.4	0.5	0.6	0.7	0.8	0.9	1.0	
+ Setting																					
Cooling Speed	Low	19	33	51	67	81	97	113	128	144	47	64	90	111	127	153	174	193	215	234	250
	Med-low	35	52	76	90	108	130	146	166	185	87	114	130	158	184	205	227	252	278	301	321
	Med-High	51	70	92	117	138	155	181	199	219	146	170	199	223	246	277	303	329	357	379	399
	High	69	94	113	133	152	177	194	222	246	225	250	277	308	329	362	391	411	442	465	489
Factory Default																					
Cooling Speed	Low	14	31	44	59	75	88	104	125	137	37	54	74	94	114	135	152	175	187	209	223
	Med-low	29	46	63	80	95	114	133	146	164	65	87	108	130	152	173	196	222	236	262	283
	Med-High	39	56	78	97	117	137	155	175	192	102	127	152	175	202	228	246	279	306	328	345
	High	46	68	86	111	126	154	174	194	214	167	184	218	253	272	301	332	360	381	402	421
- Setting																					
Cooling Speed	Low	11	27	39	57	70	84	99	113	131	26	45	61	81	96	118	134	152	169	189	205
	Med-low	23	39	53	71	87	103	118	133	148	44	60	85	107	127	150	169	186	207	226	247
	Med-High	24	43	56	79	97	111	129	149	165	75	101	117	140	160	182	215	235	255	275	296
	High	33	51	69	94	111	131	150	170	186	112	134	160	186	220	236	264	293	311	335	363

BLOWER DATA

EL297UH090XV36C BLOWER PERFORMANCE (less filter)

SINGLE SIDE RETURN AIR

0 through 0.8 in. w.g. (Heating) and 0 through 1.0 in. w.g. (Cooling) External Static Pressure Range

HEATING

¹ Heating Speed DIP Switch Settings	First Stage Heating Speed - cfm		Second Stage Heating Speed - cfm	
	+24%	1170		1245
+18%	1125		1190	
+12%	1075		1145	
+6%	1005		1075	
Factory Default	935		1030	
-6%	880		950	
-12%	810		890	
-18%	775		820	

COOLING

¹ Cooling Speed DIP Switch Settings	First Stage Cooling Speed - cfm				Second Stage Cooling Speed - cfm			
	Low	Medium-Low	Medium-High	² High	Low	Medium-Low	Medium-High	² High
+	610	705	795	920	840	1015	1165	1300
Factory Default	560	640	715	810	770	910	1050	1190
-	525	605	665	725	695	795	945	1110

¹ Cooling and heating speeds are based on a combination of DIP switch settings on the furnace control. Refer to Installation Instructions for specific DIP Switch Settings.

² Factory default setting.

NOTES - The effect of static pressure is included in air volumes shown.

First stage HEAT is approximately 91% of the same second stage HEAT.

First stage COOL (two-stage air conditioning units only) is approximately 70% of the same second stage COOL speed position.

Continuous Fan Only speed is selectable at 28% and 38% of the selected second stage cooling speed - minimum 250 cfm.

Lennox® Smart Zoning System Applications - Minimum blower speed is 250 cfm.

EL297UH090XV36C BLOWER MOTOR WATTS (COOLING)

¹ Cooling Speed DIP Switch Settings	Motor Watts @ Various External Static Pressures - in. w.g.																				
	First Stage										Second Stage										
	0	0.1	0.2	0.3	0.4	0.5	0.6	0.7	0.8	0	0.1	0.2	0.3	0.4	0.5	0.6	0.7	0.8	0.9	1.0	
+ Setting																					
Cooling Speed	Low	13	30	46	62	75	93	110	129	143	42	60	83	101	122	144	163	181	206	219	241
	Med-low	25	45	62	80	96	115	134	151	173	78	104	122	144	170	195	215	239	265	283	308
	Med-High	36	55	79	95	117	139	156	178	199	233	154	175	213	236	269	282	309	336	357	381
	High	62	83	105	128	148	163	193	210	234	210	229	259	291	317	344	366	391	415	441	466
Factory Default																					
Cooling Speed	Low	9	28	38	55	71	83	100	116	135	28	48	65	86	104	124	142	164	182	199	219
	Med-low	20	38	52	69	83	102	120	135	152	59	81	100	125	142	162	182	204	229	248	269
	Med-High	26	46	63	83	101	117	141	157	178	95	118	142	165	192	213	244	264	288	314	329
	High	39	59	81	98	121	143	161	180	202	149	171	199	229	257	285	306	330	359	389	403
- Setting																					
Cooling Speed	Low	8	23	35	52	66	80	95	108	121	21	41	56	71	91	110	126	144	164	179	197
	Med-low	12	29	44	59	75	92	111	126	140	35	56	73	95	115	137	155	176	198	216	235
	Med-High	20	37	56	71	86	104	122	143	155	70	89	114	135	157	175	199	225	242	266	282
	High	27	47	67	82	102	124	142	160	181	104	125	150	178	207	232	251	273	297	321	350

BLOWER DATA

EL297UH090XV36C BLOWER PERFORMANCE (less filter)

SINGLE SIDE RETURN AIR WITH OPTIONAL RETURN AIR BASE

0 through 0.8 in. w.g. (Heating) and 0 through 1.0 in. w.g. (Cooling) External Static Pressure Range

HEATING

¹ Heating Speed DIP Switch Settings	First Stage Heating Speed - cfm				Second Stage Heating Speed - cfm			
	+24%	1170				1250		
+18%	1110				1200			
+12%	1045				1145			
+6%	995				1070			
Factory Default	940				1010			
-6%	880				950			
-12%	815				895			
-18%	775				825			

COOLING

¹ Cooling Speed DIP Switch Settings	First Stage Cooling Speed - cfm				Second Stage Cooling Speed - cfm			
	Low	Medium-Low	Medium-High	² High	Low	Medium-Low	Medium-High	² High
+	605	715	810	930	850	995	1165	1305
Factory Default	570	660	735	820	775	905	1050	1205
-	530	600	670	725	710	800	945	1070

¹ Cooling and heating speeds are based on a combination of DIP switch settings on the furnace control. Refer to Installation Instructions for specific DIP Switch Settings.

² Factory default setting.

NOTES - The effect of static pressure is included in air volumes shown.

First stage HEAT is approximately 91% of the same second stage HEAT.

First stage COOL (two-stage air conditioning units only) is approximately 70% of the same second stage COOL speed position.

Continuous Fan Only speed is selectable at 28% and 38% of the selected second stage cooling speed - minimum 250 cfm.

Lennox® Smart Zoning System Applications - Minimum blower speed is 250 cfm.

EL297UH090XV36C BLOWER MOTOR WATTS (COOLING)

¹ Cooling Speed DIP Switch Settings	Motor Watts @ Various External Static Pressures - in. wg.																				
	First Stage										Second Stage										
	0	0.1	0.2	0.3	0.4	0.5	0.6	0.7	0.8	0	0.1	0.2	0.3	0.4	0.5	0.6	0.7	0.8	0.9	1.0	
+ Setting																					
Cooling Speed	Low	12	29	43	59	75	92	111	123	139	41	62	86	102	123	145	165	185	205	229	253
	Med-low	24	42	61	76	97	112	132	150	169	79	108	126	148	174	190	218	248	273	294	316
	Med-High	38	56	81	99	115	138	157	176	199	131	152	184	208	237	264	289	320	339	361	390
	High	61	85	104	127	144	171	192	212	239	205	226	258	283	312	344	365	393	410	437	466
Factory Default																					
Cooling Speed	Low	9	26	37	54	67	83	97	112	130	30	50	72	87	108	127	149	167	184	209	226
	Med-low	19	37	53	67	83	101	119	135	153	62	86	101	129	144	165	189	215	232	251	275
	Med-High	27	48	65	82	101	119	139	161	177	91	114	140	163	195	220	239	265	289	315	339
	High	42	62	85	99	121	143	162	183	203	149	167	201	228	258	289	316	333	355	389	403
- Setting																					
Cooling Speed	Low	8	23	35	51	62	77	91	104	119	25	45	61	75	91	112	131	147	166	184	198
	Med-low	13	29	46	60	78	93	110	125	140	40	61	81	103	119	143	162	179	204	220	245
	Med-High	22	41	57	70	88	109	127	144	159	70	92	120	133	165	178	203	231	246	274	301
	High	29	50	69	83	106	123	143	164	183	101	124	151	180	203	227	257	276	306	326	358

BLOWER DATA WITH BLOWER DRIVE (See Earlier Version EHB For CFM With No Blower Drive)

EL297UH090XV48C BLOWER PERFORMANCE (less filter)

BOTTOM RETURN AIR

0 through 0.8 in. w.g. (Heating) and 0 through 1.0 in. w.g. (Cooling) External Static Pressure Range

HEATING

¹ Heating Speed DIP Switch Settings	First Stage Heating Speed - cfm	Second Stage Heating Speed - cfm
+24%	1490	1645
+18%	1415	1565
+12%	1330	1480
+6%	1295	1405
Factory Default	1220	1325
-6%	1150	1260
-12%	1065	1190
-18%	1010	1105

COOLING

¹ Cooling Speed DIP Switch Settings	First Stage Cooling Speed - cfm				Second Stage Cooling Speed - cfm			
	Low	Medium-Low	Medium-High	² High	Low	Medium-Low	Medium-High	² High
+	795	950	1080	1260	1115	1355	1550	1775
Factory Default	730	870	985	1140	1015	1220	1430	1605
-	650	790	890	1020	930	1105	1285	1470

¹ Cooling and heating speeds are based on a combination of DIP switch settings on the furnace control. Refer to Installation Instructions for specific DIP Switch Settings.

² Factory default setting.

NOTES - The effect of static pressure is included in air volumes shown.

First stage HEAT is approximately 91% of the same second stage HEAT.

First stage COOL (two-stage air conditioning units only) is approximately 70% of the same second stage COOL speed position.

Continuous Fan Only speed is selectable at 28% and 38% of the selected second stage cooling speed - minimum 380 cfm.

Lennox® Smart Zoning System Applications - Minimum blower speed is 380 cfm.

EL297UH090XV48C BLOWER MOTOR WATTS (COOLING)

¹ Cooling Speed DIP Switch Settings	Motor Watts @ Various External Static Pressures - in. w.g.																			
	First Stage										Second Stage									
	0	0.1	0.2	0.3	0.4	0.5	0.6	0.7	0.8	0	0.1	0.2	0.3	0.4	0.5	0.6	0.7	0.8	0.9	1.0

+ Setting

Cooling Speed	Low	38	62	81	101	122	143	165	188	214	89	123	148	175	200	228	257	287	318	349	381
	Med-low	63	88	109	133	158	184	211	226	253	159	196	226	257	288	320	353	386	421	457	492
	Med-High	85	116	140	166	189	217	246	275	305	246	289	321	353	387	421	457	494	532	571	615
	High	132	165	194	223	253	284	316	349	381	382	426	464	497	537	577	610	650	696	738	781

Factory Default

Cooling Speed	Low	31	54	71	91	110	130	151	174	196	70	101	123	148	176	200	223	253	280	308	337
	Med-low	49	74	95	116	138	161	185	211	232	115	151	178	206	236	266	297	328	361	394	426
	Med-High	68	95	117	141	167	196	215	242	270	188	225	258	290	323	356	390	424	461	497	535
	High	97	129	155	179	206	236	265	296	327	278	321	354	387	421	457	492	531	568	609	650

- Setting

Cooling Speed	Low	28	53	62	80	98	117	136	156	177	55	82	102	124	148	173	199	221	241	267	295
	Med-low	37	61	81	101	121	142	164	187	213	84	118	143	171	193	223	254	284	314	345	375
	Med-High	52	78	98	120	143	167	193	218	236	136	173	201	229	260	289	321	353	386	421	456
	High	74	102	125	150	178	200	226	256	284	206	243	277	309	344	377	412	449	486	520	556

BLOWER DATA

EL297UH090XV48C BLOWER PERFORMANCE (less filter)

SINGLE SIDE RETURN AIR

0 through 0.8 in. w.g. (Heating) and 0 through 1.0 in. w.g. (Cooling) External Static Pressure Range

HEATING		
¹ Heating Speed DIP Switch Settings	First Stage Heating Speed - cfm	Second Stage Heating Speed - cfm
+24%	1400	1570
+18%	1380	1475
+12%	1310	1415
+6%	1255	1360
Factory Default	1210	1285
-6%	1125	1260
-12%	1080	1150
-18%	990	1115

COOLING								
¹ Cooling Speed DIP Switch Settings	First Stage Cooling Speed - cfm				Second Stage Cooling Speed - cfm			
	Low	Medium-Low	Medium-High	² High	Low	Medium-Low	Medium-High	² High
+	820	1005	1135	1290	1140	1340	1525	1725
Factory Default	755	880	1025	1150	1040	1235	1395	1565
-	680	815	925	1065	910	1120	1275	1400

¹ Cooling and heating speeds are based on a combination of DIP switch settings on the furnace control. Refer to Installation Instructions for specific DIP Switch Settings.

² Factory default setting.

NOTES - The effect of static pressure is included in air volumes shown.

First stage HEAT is approximately 91% of the same second stage HEAT.

First stage COOL (two-stage air conditioning units only) is approximately 70% of the same second stage COOL speed position.

Continuous Fan Only speed is selectable at 28% and 38% of the selected second stage cooling speed - minimum 380 cfm.

Lennox® Smart Zoning System Applications - Minimum blower speed is 380 cfm.

EL297UH090XV48C BLOWER MOTOR WATTS (COOLING)

¹ Cooling Speed DIP Switch Settings	Motor Watts @ Various External Static Pressures - in. wg.																				
	First Stage										Second Stage										
	0	0.1	0.2	0.3	0.4	0.5	0.6	0.7	0.8	0	0.1	0.2	0.3	0.4	0.5	0.6	0.7	0.8	0.9	1.0	
+ Setting																					
Cooling Speed	Low	43	65	85	96	119	134	156	179	199	102	131	155	189	216	249	282	304	331	359	387
	Med-low	66	95	113	140	164	189	212	242	268	173	196	242	271	306	337	362	405	430	460	493
	Med-High	95	126	151	180	210	242	277	302	320	243	277	316	371	412	457	492	534	566	605	651
	High	143	166	203	243	282	309	333	368	389	368	410	453	511	562	604	651	690	730	771	809
Factory Default																					
Cooling Speed	Low	36	48	73	86	108	120	140	152	168	75	101	125	156	178	215	244	259	288	320	339
	Med-low	52	75	95	110	130	161	176	201	216	129	154	190	218	257	295	322	346	377	404	434
	Med-High	70	94	125	146	172	198	230	252	275	190	222	270	299	325	368	398	439	470	508	549
	High	100	131	162	197	228	260	298	328	347	275	310	359	400	445	469	525	562	597	642	682
- Setting																					
Cooling Speed	Low	32	45	58	80	97	110	121	133	154	62	87	109	129	152	173	199	221	250	266	295
	Med-low	45	63	82	99	119	137	150	171	193	95	124	150	180	207	240	269	297	325	356	375
	Med-High	55	82	101	119	145	167	192	213	239	148	177	205	244	286	309	346	370	402	431	467
	High	76	101	137	160	188	218	245	271	302	198	239	274	308	349	384	426	471	500	542	576

BLOWER DATA

EL297UH090XV48C BLOWER PERFORMANCE (less filter)

SINGLE SIDE RETURN AIR WITH OPTIONAL RETURN AIR BASE

0 through 0.8 in. w.g. (Heating) and 0 through 1.0 in. w.g. (Cooling) External Static Pressure Range

HEATING

¹ Heating Speed DIP Switch Settings	First Stage Heating Speed - cfm	Second Stage Heating Speed - cfm
+24%	1430	1565
+18%	1400	1500
+12%	1330	1410
+6%	1260	1380
Factory Default	1195	1305
-6%	1135	1275
-12%	1065	1180
-18%	990	1095

COOLING

¹ Cooling Speed DIP Switch Settings	First Stage Cooling Speed - cfm				Second Stage Cooling Speed - cfm			
	Low	Medium-Low	Medium-High	² High	Low	Medium-Low	Medium-High	² High
+	840	955	1120	1280	1160	1360	1530	1740
Factory Default	775	910	1010	1170	1060	1240	1400	1590
-	695	815	930	1045	925	1130	1295	1440

¹ Cooling and heating speeds are based on a combination of DIP switch settings on the furnace control. Refer to Installation Instructions for specific DIP Switch Settings.

² Factory default setting.

NOTES - The effect of static pressure is included in air volumes shown.

First stage HEAT is approximately 91% of the same second stage HEAT.

First stage COOL (two-stage air conditioning units only) is approximately 70% of the same second stage COOL speed position.

Continuous Fan Only speed is selectable at 28% and 38% of the selected second stage cooling speed - minimum 380 cfm.

Lennox® Smart Zoning System Applications - Minimum blower speed is 380 cfm.

EL297UH090XV48C BLOWER MOTOR WATTS (COOLING)

¹ Cooling Speed DIP Switch Settings	Motor Watts @ Various External Static Pressures - in. w.g.																				
	First Stage										Second Stage										
	0	0.1	0.2	0.3	0.4	0.5	0.6	0.7	0.8	0	0.1	0.2	0.3	0.4	0.5	0.6	0.7	0.8	0.9	1.0	
+ Setting																					
Cooling Speed	Low	40	60	80	96	115	133	151	176	192	94	127	151	180	207	241	274	303	340	358	381
	Med-low	58	87	108	132	158	188	212	240	264	166	195	233	269	300	328	356	394	426	455	496
	Med-High	91	126	145	169	205	228	255	288	320	234	273	314	354	403	431	484	514	571	599	632
	High	134	163	195	231	264	297	320	359	381	337	378	426	470	518	557	604	654	684	722	768
Factory Default																					
Cooling Speed	Low	36	47	70	88	103	120	139	146	167	75	100	130	149	183	212	238	260	293	315	337
	Med-low	51	75	93	115	135	158	187	201	222	132	156	192	220	259	284	319	343	376	404	423
	Med-High	59	92	112	141	166	200	228	259	281	183	215	262	284	315	348	387	427	464	494	523
	High	97	130	156	191	215	256	283	310	343	253	292	331	379	414	462	497	546	575	613	661
- Setting																					
Cooling Speed	Low	26	41	55	73	88	104	120	134	149	56	84	104	123	149	174	199	224	248	268	290
	Med-low	41	62	79	98	117	132	154	172	195	94	122	146	177	208	239	264	295	320	352	368
	Med-High	50	75	95	120	147	164	187	209	243	140	170	197	234	263	301	327	357	377	412	453
	High	72	102	125	154	178	208	234	262	293	196	235	264	302	332	377	413	441	482	518	548

BLOWER DATA

EL297UH090XV60C BLOWER PERFORMANCE (less filter)

BOTTOM RETURN AIR

0 through 0.8 in. w.g. (Heating) and 0 through 1.0 in. w.g. (Cooling) External Static Pressure Range

HEATING

¹ Heating Speed DIP Switch Settings	First Stage Heating Speed - cfm	Second Stage Heating Speed - cfm
+24%	1490	1985
+18%	1435	1915
+12%	1335	1805
+6%	1280	1645
Factory Default	1185	1625
-6%	1095	1530
-12%	990	1450
-18%	900	1345

COOLING

¹ Cooling Speed DIP Switch Settings	First Stage Cooling Speed - cfm				Second Stage Cooling Speed - cfm			
	Low	Medium-Low	Medium-High	² High	Low	Medium-Low	Medium-High	² High
+	1050	1270	1445	1620	1590	1815	2010	2195
Factory Default	975	1120	1295	1460	1460	1645	1845	2010
-	865	1010	1120	1290	1320	1500	1645	1860

¹ Cooling and heating speeds are based on a combination of DIP switch settings on the furnace control. Refer to Installation Instructions for specific DIP Switch Settings.

² Factory default setting.

NOTES - The effect of static pressure is included in air volumes shown.

First stage HEAT is approximately 91% of the same second stage HEAT.

First stage COOL (two-stage air conditioning units only) is approximately 70% of the same second stage COOL speed position.

Continuous Fan Only speed is selectable at 28% and 38% of the selected second stage cooling speed - minimum 450 cfm.

Lennox® Smart Zoning System Applications - Minimum blower speed is 450 cfm.

EL297UH090XV60C BLOWER MOTOR WATTS (COOLING)

¹ Cooling Speed DIP Switch Settings	Motor Watts @ Various External Static Pressures - in. wg.																				
	First Stage										Second Stage										
	0	0.1	0.2	0.3	0.4	0.5	0.6	0.7	0.8	0	0.1	0.2	0.3	0.4	0.5	0.6	0.7	0.8	0.9	1.0	
+ Setting																					
Cooling Speed	Low	79	107	135	157	188	215	245	273	293	264	284	346	390	425	453	503	538	580	607	640
	Med-low	120	152	188	220	264	298	328	365	389	393	422	484	554	582	629	690	737	778	805	859
	Med-High	191	221	272	304	333	372	414	452	481	582	604	679	726	778	839	887	921	970	1008	1039
	High	264	284	346	390	425	453	503	538	580	805	845	888	949	1009	1048	1109	1133	1166	1196	1191
Factory Default																					
Cooling Speed	Low	60	86	112	129	152	179	202	232	252	202	218	270	315	351	387	419	452	479	512	546
	Med-low	90	123	149	174	209	235	264	293	331	286	340	389	378	430	503	553	580	636	661	699
	Med-High	137	166	203	240	279	307	342	372	402	454	467	517	573	632	672	717	767	809	849	880
	High	202	218	270	315	351	387	419	452	479	559	590	649	728	789	823	896	926	974	1030	1062
- Setting																					
Cooling Speed	Low	47	62	85	107	132	148	166	179	201	142	168	212	247	285	313	348	373	409	450	472
	Med-low	69	97	119	139	165	189	214	244	265	226	245	295	339	374	410	451	474	497	549	566
	Med-High	90	123	149	174	209	235	264	293	331	301	335	385	430	471	510	557	607	632	677	713
	High	133	167	200	232	274	311	340	371	405	454	470	553	588	641	695	725	764	820	849	880

BLOWER DATA

EL297UH090XV60C BLOWER PERFORMANCE (less filter)

SINGLE SIDE RETURN AIR – Air volumes in **bold** require Optional Return Air Base and field fabricated transition to accommodate 20 x 25 x 1 in. air filter in order to maintain proper air velocity.

0 through 0.8 in. w.g. (Heating) and 0 through 1.0 in. w.g. (Cooling) External Static Pressure Range

HEATING

¹ Heating Speed DIP Switch Settings	First Stage Heating Speed - cfm	Second Stage Heating Speed - cfm
+24%	1445	1920
+18%	1385	1875
+12%	1275	1735
+6%	1245	1600
Factory Default	1155	1565
-6%	1070	1480
-12%	975	1400
-18%	920	1275

COOLING

¹ Cooling Speed DIP Switch Settings	First Stage Cooling Speed - cfm				Second Stage Cooling Speed - cfm			
	Low	Medium-Low	Medium-High	² High	Low	Medium-Low	Medium-High	² High
+	1040	1225	1380	1550	1555	1715	1920	2135
Factory Default	960	1085	1225	1415	1430	1565	1790	1980
-	840	990	1085	1250	1280	1450	1580	1790

¹ Cooling and heating speeds are based on a combination of DIP switch settings on the furnace control. Refer to Installation Instructions for specific DIP Switch Settings.

² Factory default setting.

NOTES - The effect of static pressure is included in air volumes shown.

First stage HEAT is approximately 91% of the same second stage HEAT.

First stage COOL (two-stage air conditioning units only) is approximately 70% of the same second stage COOL speed position.

Continuous Fan Only speed is selectable at 28% and 38% of the selected second stage cooling speed - minimum 450 cfm.

Lennox® Smart Zoning System Applications - Minimum blower speed is 450 cfm.

EL297UH090XV60C BLOWER MOTOR WATTS (COOLING)

¹ Cooling Speed DIP Switch Settings	Motor Watts @ Various External Static Pressures - in. w.g.																				
	First Stage										Second Stage										
	0	0.1	0.2	0.3	0.4	0.5	0.6	0.7	0.8	0	0.1	0.2	0.3	0.4	0.5	0.6	0.7	0.8	0.9	1.0	
+ Setting																					
Cooling Speed	Low	66	95	123	147	173	204	233	260	290	241	273	315	357	405	433	466	519	547	584	620
	Med-low	108	139	173	210	248	283	315	342	376	332	374	428	489	518	568	631	665	719	762	813
	Med-High	159	192	233	272	314	359	386	421	457	518	557	601	675	713	772	819	873	913	949	987
	High	241	273	315	357	405	433	466	519	547	713	750	822	866	946	986	1042	1085	1116	1144	1184
Factory Default																					
Cooling Speed	Low	55	81	101	126	144	165	194	217	243	181	204	251	292	323	369	403	444	474	496	525
	Med-low	75	109	134	159	194	226	255	282	316	270	304	361	389	433	473	506	547	602	642	665
	Med-High	108	144	180	211	248	293	320	357	391	374	410	467	512	583	618	670	723	778	797	839
	High	181	204	251	292	323	369	403	444	474	542	579	642	684	743	809	843	883	942	991	1019
- Setting																					
Cooling Speed	Low	36	56	71	102	119	141	161	179	198	113	142	181	221	255	300	325	352	395	424	456
	Med-low	57	84	110	133	151	175	210	234	257	170	208	209	303	343	382	417	455	489	509	552
	Med-High	75	109	134	159	194	226	255	282	316	264	299	357	387	426	478	501	551	586	635	682
	High	113	142	181	221	255	300	325	352	395	374	410	467	512	583	618	670	723	778	797	839

BLOWER DATA WITH BLOWER DRIVE (See Earlier Version EHB For CFM With No Blower Drive)

EL297UH110XV48C BLOWER PERFORMANCE (less filter)

BOTTOM RETURN AIR

0 through 0.8 in. w.g. (Heating) and 0 through 1.0 in. w.g. (Cooling) External Static Pressure Range

HEATING

¹ Heating Speed DIP Switch Settings	First Stage Heating Speed - cfm	Second Stage Heating Speed - cfm
+24%	1470	1605
+18%	1450	1495
+12%	1385	1445
+6%	1295	1385
Factory Default	1225	1305
-6%	1160	1225
-12%	1090	1150
-18%	1035	1070

COOLING

¹ Cooling Speed DIP Switch Settings	First Stage Cooling Speed - cfm				Second Stage Cooling Speed - cfm			
	Low	Medium-Low	Medium-High	² High	Low	Medium-Low	Medium-High	² High
+	765	920	1040	1230	1085	1310	1515	1745
Factory Default	705	835	960	1100	985	1185	1395	1565
-	635	765	860	985	890	1070	1245	1425

¹ Cooling and heating speeds are based on a combination of DIP switch settings on the furnace control. Refer to Installation Instructions for specific DIP Switch Settings.

² Factory default setting.

NOTES - The effect of static pressure is included in air volumes shown.

First stage HEAT is approximately 91% of the same second stage HEAT.

First stage COOL (two-stage air conditioning units only) is approximately 70% of the same second stage COOL speed position.

Continuous Fan Only speed is selectable at 28% and 38% of the selected second stage cooling speed - minimum 380 cfm.

Lennox® Smart Zoning System Applications - Minimum blower speed is 380 cfm.

EL297UH110XV48C BLOWER MOTOR WATTS (COOLING)

¹ Cooling Speed DIP Switch Settings	Motor Watts @ Various External Static Pressures - in. wg.																			
	First Stage										Second Stage									
	0	0.1	0.2	0.3	0.4	0.5	0.6	0.7	0.8	0	0.1	0.2	0.3	0.4	0.5	0.6	0.7	0.8	0.9	1.0

+ Setting

Cooling Speed	Low	32	58	73	90	109	130	151	175	199	73	104	128	152	178	203	230	257	285	314	344
	Med-low	54	78	97	118	141	163	184	207	231	138	171	199	227	256	285	313	343	374	407	441
	Med-High	70	99	121	145	169	195	221	248	276	212	251	281	313	344	377	409	445	480	517	554
	High	115	145	171	197	225	253	281	310	340	316	360	396	431	465	502	545	582	618	662	707

Factory Default

Cooling Speed	Low	31	58	64	81	100	119	139	159	181	55	86	107	129	151	174	201	227	254	281	309
	Med-low	41	65	83	102	122	145	170	191	210	100	132	157	183	209	236	264	292	321	352	384
	Med-High	56	82	102	125	147	167	192	218	245	161	197	226	256	286	317	348	380	413	448	482
	High	83	111	135	160	185	212	238	266	293	234	274	305	336	369	402	437	471	507	544	582

- Setting

Cooling Speed	Low	30	57	58	73	90	107	124	142	162	45	71	90	110	132	156	177	198	220	245	270
	Med-low	30	57	72	90	109	129	151	175	201	68	100	123	147	173	199	225	252	280	309	339
	Med-High	45	70	87	106	127	150	173	194	214	118	151	177	204	231	259	288	316	347	378	411
	High	60	88	110	132	154	178	204	230	258	173	209	239	269	300	332	365	397	431	466	501

BLOWER DATA

EL297UH110XV48C BLOWER PERFORMANCE (less filter)

SINGLE SIDE RETURN AIR

0 through 0.8 in. w.g. (Heating) and 0 through 1.0 in. w.g. (Cooling) External Static Pressure Range

HEATING		
¹ Heating Speed DIP Switch Settings	First Stage Heating Speed - cfm	Second Stage Heating Speed - cfm
+24%	1480	1580
+18%	1410	1505
+12%	1330	1415
+6%	1255	1365
Factory Default	1190	1270
-6%	1130	1205
-12%	1070	1120
-18%	1020	1060

COOLING								
¹ Cooling Speed DIP Switch Settings	First Stage Cooling Speed - cfm				Second Stage Cooling Speed - cfm			
	Low	Medium-Low	Medium-High	² High	Low	Medium-Low	Medium-High	² High
+	795	975	1065	1200	1085	1295	1515	1695
Factory Default	755	855	1000	1110	1015	1180	1375	1565
-	700	785	885	1025	920	1070	1235	1395

¹ Cooling and heating speeds are based on a combination of DIP switch settings on the furnace control. Refer to Installation Instructions for specific DIP Switch Settings.

² Factory default setting.

NOTES - The effect of static pressure is included in air volumes shown.

First stage HEAT is approximately 91% of the same second stage HEAT.

First stage COOL (two-stage air conditioning units only) is approximately 70% of the same second stage COOL speed position.

Continuous Fan Only speed is selectable at 28% and 38% of the selected second stage cooling speed - minimum 380 cfm.

Lennox® Smart Zoning System Applications - Minimum blower speed is 380 cfm.

EL297UH110XV48C BLOWER MOTOR WATTS (COOLING)

¹ Cooling Speed DIP Switch Settings	Motor Watts @ Various External Static Pressures - in. wg.																				
	First Stage										Second Stage										
	0	0.1	0.2	0.3	0.4	0.5	0.6	0.7	0.8	0	0.1	0.2	0.3	0.4	0.5	0.6	0.7	0.8	0.9	1.0	
+ Setting																					
Cooling Speed	Low	35	58	79	99	120	148	166	192	209	79	107	142	168	196	225	254	286	314	344	376
	Med-low	52	81	103	132	153	178	212	236	262	130	167	199	237	272	313	350	392	419	457	486
	Med-High	93	128	156	183	207	246	274	314	339	215	246	290	334	375	416	457	490	528	569	598
	High	108	144	175	207	241	276	308	345	376	287	333	383	427	482	515	571	614	666	716	756
Factory Default																					
Cooling Speed	Low	28	49	69	92	110	128	147	175	192	63	88	122	143	169	198	224	250	281	311	330
	Med-low	40	65	85	110	135	155	180	205	235	100	136	166	195	227	261	291	329	358	394	423
	Med-High	59	85	115	139	163	190	220	245	274	154	192	229	270	309	345	383	428	459	503	534
	High	85	116	148	175	201	235	263	299	325	245	280	328	370	412	444	488	521	570	608	650
- Setting																					
Cooling Speed	Low	25	42	60	82	103	113	137	152	173	46	72	94	120	146	170	197	226	249	268	293
	Med-low	39	62	82	102	120	140	165	187	207	74	99	137	162	193	218	247	276	305	337	366
	Med-High	43	71	92	116	142	165	190	217	243	113	150	181	214	247	286	320	358	388	425	451
	High	65	89	125	146	173	201	227	254	285	164	202	244	285	315	356	398	441	476	518	550

BLOWER DATA

EL297UH110XV48C BLOWER PERFORMANCE (less filter)

SINGLE SIDE RETURN AIR WITH OPTIONAL RETURN AIR BASE

0 through 0.8 in. w.g. (Heating) and 0 through 1.0 in. w.g. (Cooling) External Static Pressure Range

HEATING

¹ Heating Speed DIP Switch Settings	First Stage Heating Speed - cfm		Second Stage Heating Speed - cfm	
	+24%	1465		1560
+18%	1370		1490	
+12%	1310		1400	
+6%	1235		1340	
Factory Default	1185		1270	
-6%	1120		1210	
-12%	1060		1120	
-18%	1015		1065	

COOLING

¹ Cooling Speed DIP Switch Settings	First Stage Cooling Speed - cfm				Second Stage Cooling Speed - cfm			
	Low	Medium-Low	Medium-High	² High	Low	Medium-Low	Medium-High	² High
+	800	935	1055	1190	1085	1285	1500	1680
Factory Default	745	860	980	1100	1015	1185	1355	1550
-	670	790	890	1025	920	1075	1240	1385

¹ Cooling and heating speeds are based on a combination of DIP switch settings on the furnace control. Refer to Installation Instructions for specific DIP Switch Settings.

² Factory default setting.

NOTES - The effect of static pressure is included in air volumes shown.

First stage HEAT is approximately 91% of the same second stage HEAT.

First stage COOL (two-stage air conditioning units only) is approximately 70% of the same second stage COOL speed position.

Continuous Fan Only speed is selectable at 28% and 38% of the selected second stage cooling speed - minimum 380 cfm.

Lennox® Smart Zoning System Applications - Minimum blower speed is 380 cfm.

EL297UH110XV48C BLOWER MOTOR WATTS (COOLING)

¹ Cooling Speed DIP Switch Settings	Motor Watts @ Various External Static Pressures - in. wg.																				
	First Stage										Second Stage										
	0	0.1	0.2	0.3	0.4	0.5	0.6	0.7	0.8	0	0.1	0.2	0.3	0.4	0.5	0.6	0.7	0.8	0.9	1.0	
+ Setting																					
Cooling Speed	Low	35	58	79	99	120	148	166	192	209	73	108	132	158	184	214	244	279	309	336	363
	Med-low	44	75	92	117	150	170	198	230	249	110	150	178	209	248	288	324	355	389	430	460
	Med-High	69	102	126	154	178	206	235	274	299	187	230	262	305	337	378	429	463	501	536	573
	High	94	133	162	185	216	255	294	321	360	270	319	361	403	440	494	538	580	629	670	718
Factory Default																					
Cooling Speed	Low	27	50	69	87	102	127	150	168	192	59	88	116	136	161	194	218	251	272	302	325
	Med-low	35	60	80	100	125	150	175	195	225	86	126	154	177	205	242	280	306	345	377	409
	Med-High	54	83	107	128	157	184	210	243	263	131	172	203	240	279	318	351	390	426	469	500
	High	78	113	137	162	189	221	252	284	317	210	252	291	327	376	413	456	493	529	570	620
- Setting																					
Cooling Speed	Low	24	42	65	80	93	116	135	155	173	37	66	89	111	140	163	190	202	239	266	296
	Med-low	32	57	75	94	114	136	161	184	205	71	104	128	155	180	208	237	276	302	327	352
	Med-High	38	65	85	106	135	158	184	200	233	97	137	166	191	225	264	304	330	367	402	434
	High	61	91	118	139	164	196	221	255	276	145	182	220	259	299	333	374	410	449	487	523

BLOWER DATA

EL297UH110XV60C BLOWER PERFORMANCE (less filter)

BOTTOM RETURN AIR

0 through 0.8 in. w.g. (Heating) and 0 through 1.0 in. w.g. (Cooling) External Static Pressure Range

HEATING

¹ Heating Speed DIP Switch Settings	First Stage Heating Speed - cfm	Second Stage Heating Speed - cfm
+24%	1385	1965
+18%	1475	1880
+12%	1355	1790
+6%	1370	1725
Factory Default	1200	1630
-6%	1140	1550
-12%	1070	1460
-18%	980	1345

COOLING

¹ Cooling Speed DIP Switch Settings	First Stage Cooling Speed - cfm				Second Stage Cooling Speed - cfm			
	Low	Medium-Low	Medium-High	² High	Low	Medium-Low	Medium-High	² High
+	1060	1245	1345	1545	1560	1740	1930	2125
Factory Default	970	1145	1265	1395	1405	1565	1775	1945
-	885	1025	1110	1250	1270	1425	1610	1770

¹ Cooling and heating speeds are based on a combination of DIP switch settings on the furnace control. Refer to Installation Instructions for specific DIP Switch Settings.

² Factory default setting.

NOTES - The effect of static pressure is included in air volumes shown.

First stage HEAT is approximately 91% of the same second stage HEAT.

First stage COOL (two-stage air conditioning units only) is approximately 70% of the same second stage COOL speed position.

Continuous Fan Only speed is selectable at 28% and 38% of the selected second stage cooling speed - minimum 450 cfm.

Lennox® Smart Zoning System Applications - Minimum blower speed is 450 cfm.

EL297UH110XV60C BLOWER MOTOR WATTS (COOLING)

¹ Cooling Speed DIP Switch Settings	Motor Watts @ Various External Static Pressures - in. wg.																				
	First Stage										Second Stage										
	0	0.1	0.2	0.3	0.4	0.5	0.6	0.7	0.8	0	0.1	0.2	0.3	0.4	0.5	0.6	0.7	0.8	0.9	1.0	
+ Setting																					
Cooling Speed	Low	81	113	135	165	200	228	251	280	315	220	254	300	346	385	432	472	511	560	600	610
	Med-low	119	147	179	210	241	273	309	331	358	345	386	414	475	516	547	594	637	681	714	748
	Med-High	157	191	225	265	304	331	377	405	435	492	536	573	623	666	711	761	804	842	891	918
	High	220	254	300	346	385	432	472	511	560	675	699	767	839	876	915	973	1033	1062	1115	1134
Factory Default																					
Cooling Speed	Low	60	88	114	137	167	187	219	244	276	163	196	231	266	309	348	388	421	451	489	512
	Med-low	81	108	147	173	195	231	257	288	326	232	263	314	353	412	445	490	516	557	596	649
	Med-High	122	145	182	215	246	286	306	333	360	372	401	449	498	541	577	643	672	695	744	765
	High	163	196	231	266	309	348	388	421	451	497	539	579	646	681	734	773	817	851	904	957
- Setting																					
Cooling Speed	Low	45	62	96	116	132	153	179	199	227	124	146	189	215	245	279	316	331	373	396	423
	Med-low	56	85	115	134	159	185	215	251	270	163	195	243	270	314	353	397	414	470	496	535
	Med-High	80	114	141	161	203	230	256	294	318	248	274	324	386	416	470	494	539	583	620	652
	High	124	146	189	215	245	279	316	331	373	377	413	457	502	548	583	629	684	705	753	783

BLOWER DATA

EL297UH110XV60C BLOWER PERFORMANCE (less filter)

SINGLE SIDE RETURN AIR – Air volumes in **bold** require Optional Return Air Base and field fabricated transition to accommodate 20 x 25 x 1 in. air filter in order to maintain proper air velocity.

0 through 0.8 in. w.g. (Heating) and 0 through 1.0 in. w.g. (Cooling) External Static Pressure Range

HEATING

¹ Heating Speed DIP Switch Settings	First Stage Heating Speed - cfm	Second Stage Heating Speed - cfm
+24%	1495	1910
+18%	1425	1840
+12%	1335	1785
+6%	1210	1710
Factory Default	1195	1555
-6%	1140	1510
-12%	1075	1410
-18%	975	1300

COOLING

¹ Cooling Speed DIP Switch Settings	First Stage Cooling Speed - cfm				Second Stage Cooling Speed - cfm			
	Low	Medium-Low	Medium-High	² High	Low	Medium-Low	Medium-High	² High
+	1050	1195	1315	1495	1515	1710	1870	2065
Factory Default	960	1095	1220	1355	1360	1555	1755	1890
-	850	985	1095	1220	1215	1400	1555	1755

¹ Cooling and heating speeds are based on a combination of DIP switch settings on the furnace control. Refer to Installation Instructions for specific DIP Switch Settings.

² Factory default setting.

NOTES - The effect of static pressure is included in air volumes shown.

First stage HEAT is approximately 91% of the same second stage HEAT.

First stage COOL (two-stage air conditioning units only) is approximately 70% of the same second stage COOL speed position.

Continuous Fan Only speed is selectable at 28% and 38% of the selected second stage cooling speed - minimum 450 cfm.

Lennox® Smart Zoning System Applications - Minimum blower speed is 450 cfm.

EL297UH110XV60C BLOWER MOTOR WATTS (COOLING)

¹ Cooling Speed DIP Switch Settings	Motor Watts @ Various External Static Pressures - in. w.g.																				
	First Stage										Second Stage										
	0	0.1	0.2	0.3	0.4	0.5	0.6	0.7	0.8	0	0.1	0.2	0.3	0.4	0.5	0.6	0.7	0.8	0.9	1.0	
+ Setting																					
Cooling Speed	Low	67	95	124	148	172	212	241	260	287	215	247	287	338	378	412	448	497	535	557	600
	Med-low	112	140	176	200	232	262	303	323	350	332	360	420	459	500	551	601	636	666	705	747
	Med-High	151	191	221	251	283	321	356	392	431	478	513	560	611	672	701	750	801	843	865	916
	High	215	247	287	338	378	412	448	497	535	661	699	751	813	856	901	955	1005	1047	1088	1131
Factory Default																					
Cooling Speed	Low	53	82	99	128	153	172	199	231	251	156	198	217	270	297	328	371	403	440	474	515
	Med-low	81	109	136	165	198	229	259	281	307	244	272	327	361	410	446	494	527	564	600	636
	Med-High	113	144	174	209	233	269	304	323	362	387	415	458	513	552	602	644	680	719	763	807
	High	156	198	217	270	297	328	371	403	440	505	541	594	624	675	727	780	812	843	886	925
- Setting																					
Cooling Speed	Low	43	62	84	111	125	152	167	189	211	114	137	183	206	235	264	303	330	358	388	417
	Med-low	62	86	115	134	162	187	219	238	262	165	199	236	281	308	357	381	426	466	492	531
	Med-High	81	109	136	165	198	229	259	281	307	239	269	326	354	413	463	498	523	573	601	656
	High	114	137	183	206	235	264	303	330	358	387	415	458	513	552	602	644	680	719	744	776

BLOWER DATA

EL297UH135XV60D BLOWER PERFORMANCE (less filter)

BOTTOM RETURN AIR

0 through 0.8 in. w.g. (Heating) and 0 through 1.0 in. w.g. (Cooling) External Static Pressure Range

HEATING

¹ Heating Speed DIP Switch Settings	First Stage Heating Speed - cfm				Second Stage Heating Speed - cfm			
	+24%	1770				2125		
+18%	1680				2015			
+12%	1610				1935			
+6%	1485				1855			
Factory Default	1440				1740			
-6%	1360				1650			
-12%	1285				1565			
-18%	1215				1460			

COOLING

¹ Cooling Speed DIP Switch Settings	First Stage Cooling Speed - cfm				Second Stage Cooling Speed - cfm			
	Low	Medium-Low	Medium-High	² High	Low	Medium-Low	Medium-High	² High
+	1150	1310	1440	1610	1640	1840	2000	2250
Factory Default	1080	1210	1330	1475	1480	1660	1885	2035
-	985	1095	1210	1315	1330	1500	1675	1885

¹ Cooling and heating speeds are based on a combination of DIP switch settings on the furnace control. Refer to Installation Instructions for specific DIP Switch Settings.

² Factory default setting.

NOTES - The effect of static pressure is included in air volumes shown.

First stage HEAT is approximately 91% of the same second stage HEAT.

First stage COOL (two-stage air conditioning units only) is approximately 70% of the same second stage COOL speed position.

Continuous Fan Only speed is selectable at 28% and 38% of the selected second stage cooling speed - minimum 450 cfm.

Lennox® Smart Zoning System Applications - Minimum blower speed is 450 cfm.

EL297UH135XV60D BLOWER MOTOR WATTS (COOLING)

¹ Cooling Speed DIP Switch Settings	Motor Watts @ Various External Static Pressures - in. w.g.																				
	First Stage										Second Stage										
	0	0.1	0.2	0.3	0.4	0.5	0.6	0.7	0.8	0	0.1	0.2	0.3	0.4	0.5	0.6	0.7	0.8	0.9	1.0	
+ Setting																					
Cooling Speed	Low	79	108	140	173	200	232	265	290	325	229	250	310	367	396	452	487	529	557	595	639
	Med-low	125	157	190	221	264	297	325	355	390	348	385	434	482	532	571	627	655	704	736	793
	Med-High	162	199	241	268	303	350	390	426	454	505	532	597	649	689	733	782	826	872	906	942
	High	222	250	310	367	396	452	487	529	557	696	733	780	839	910	974	996	1049	1091	1138	1175
Factory Default																					
Cooling Speed	Low	63	93	119	144	173	199	230	258	284	172	210	249	277	326	361	394	444	467	513	545
	Med-low	85	115	150	190	210	245	275	310	340	238	261	329	375	427	465	505	548	589	631	670
	Med-High	125	159	190	222	260	295	325	358	391	392	426	482	518	581	619	665	699	741	789	826
	High	172	210	249	277	326	361	394	444	467	523	561	612	671	716	751	805	867	899	935	986
- Setting																					
Cooling Speed	Low	52	78	106	129	148	177	201	228	258	123	154	191	216	261	296	331	353	384	421	459
	Med-low	68	98	124	150	184	207	241	268	294	172	214	244	289	334	368	408	454	491	523	564
	Med-High	89	119	150	192	213	246	279	312	340	265	297	352	403	439	489	534	574	605	651	699
	High	123	154	191	216	261	296	331	353	384	392	426	482	518	581	619	665	699	741	789	826

BLOWER DATA

EL297UH135XV60D BLOWER PERFORMANCE (less filter)

SINGLE SIDE RETURN AIR – Air volumes in **bold** require Optional Return Air Base and field fabricated transition to accommodate 20 x 25 x 1 in. air filter in order to maintain proper air velocity.

0 through 0.8 in. w.g. (Heating) and 0 through 1.0 in. w.g. (Cooling) External Static Pressure Range

HEATING

¹ Heating Speed DIP Switch Settings	First Stage Heating Speed - cfm	Second Stage Heating Speed - cfm
+24%	1725	2070
+18%	1635	1975
+12%	1555	1900
+6%	1470	1815
Factory Default	1405	1715
-6%	1325	1610
-12%	1250	1525
-18%	1185	1420

COOLING

¹ Cooling Speed DIP Switch Settings	First Stage Cooling Speed - cfm				Second Stage Cooling Speed - cfm			
	Low	Medium-Low	Medium-High	² High	Low	Medium-Low	Medium-High	² High
+	1130	1275	1405	1555	1595	1805	1975	2180
Factory Default	1040	1185	1280	1415	1450	1625	1840	2000
-	950	1080	1185	1300	1310	1480	1655	1840

¹ Cooling and heating speeds are based on a combination of DIP switch settings on the furnace control. Refer to Installation Instructions for specific DIP Switch Settings.

² Factory default setting.

NOTES - The effect of static pressure is included in air volumes shown.

First stage HEAT is approximately 91% of the same second stage HEAT.

First stage COOL (two-stage air conditioning units only) is approximately 70% of the same second stage COOL speed position.

Continuous Fan Only speed is selectable at 28% and 38% of the selected second stage cooling speed - minimum 450 cfm.

Lennox® Smart Zoning System Applications - Minimum blower speed is 450 cfm.

EL297UH135XV60D BLOWER MOTOR WATTS (COOLING)

¹ Cooling Speed DIP Switch Settings	Motor Watts @ Various External Static Pressures - in. wg.																				
	First Stage										Second Stage										
	0	0.1	0.2	0.3	0.4	0.5	0.6	0.7	0.8	0	0.1	0.2	0.3	0.4	0.5	0.6	0.7	0.8	0.9	1.0	
+ Setting																					
Cooling Speed	Low	87	123	145	178	213	241	270	299	340	244	283	316	356	418	453	491	529	570	598	642
	Med-low	131	161	197	228	266	309	334	361	392	340	377	425	477	528	570	615	661	702	732	789
	Med-High	168	201	248	283	319	357	385	438	468	479	523	587	615	665	717	762	812	860	907	955
	High	239	283	316	356	418	453	491	529	570	661	703	770	822	862	941	994	1037	1098	1136	1177
Factory Default																					
Cooling Speed	Low	67	97	126	150	177	210	239	264	296	162	201	243	273	311	353	384	426	469	505	541
	Med-low	100	130	165	190	225	255	290	320	350	245	281	322	374	433	465	509	546	596	629	666
	Med-High	132	169	198	228	267	306	333	370	401	370	404	458	516	559	600	657	696	746	783	816
	High	163	201	243	273	311	353	384	426	469	502	544	601	639	683	744	791	845	884	927	961
- Setting																					
Cooling Speed	Low	57	84	107	133	157	177	206	236	259	126	158	192	226	265	290	326	360	392	424	459
	Med-low	73	102	132	158	185	221	252	273	302	175	213	252	291	338	366	417	453	487	521	572
	Med-High	100	130	167	193	225	257	290	320	354	254	292	343	377	431	475	521	566	604	642	678
	High	126	158	192	226	265	290	326	360	392	370	404	458	516	559	600	657	696	746	783	816

PARTS IDENTIFICATION

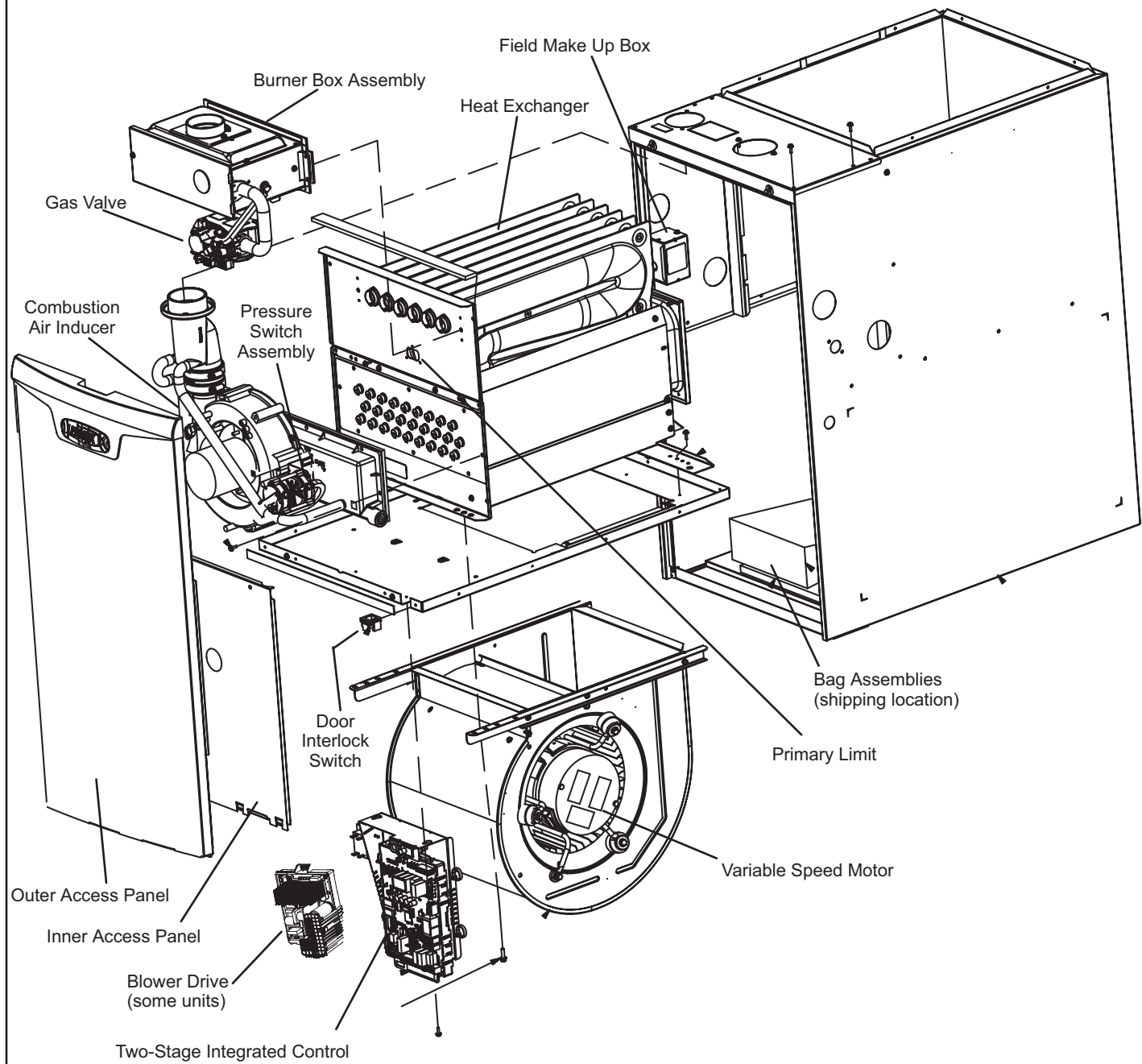



FIGURE 1

I-UNIT COMPONENTS

EL297UHV(X) unit components are shown in FIGURE 1. The gas valve, combustion air inducer and burners can be accessed by removing the access panel. Electrical components are in the control box (FIGURE 2) found in the blower section.

EL297UHV(X) units are factory equipped with a bottom return air panel in place. The panel is designed to be field removed as required for bottom air return. Markings are provided for side return air and may be cut out in the field.

ELECTROSTATIC DISCHARGE (ESD) Precautions and Procedures	
⚠ CAUTION	
	Electrostatic discharge can affect electronic components. Take precautions to neutralize electrostatic charge by touching your hand and tools to metal prior to handling the control.

A- Control Box

1. Control Transformer (T1)

A transformer located in the control box provides power to the low voltage section of the unit. Transformers on all models are rated 40VA with a 120V primary and a 24V secondary.

⚠ IMPORTANT
When matching this gas furnace with zoning, defrost tempering stat or other 24V accessories, It is recommended to replace the factory installed transformer with kit 27J32. Kit 27J32 contains a 75VA transformer, so you do not overload the original 40VA transformer.

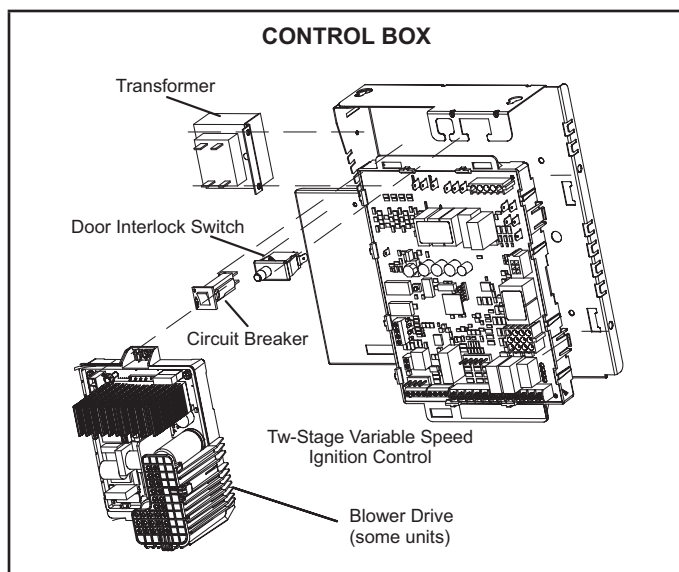

FIGURE 2

2. Door Interlock Switch (S51)

A door interlock switch rated 14A at 125VAC is wired in series with line voltage. When the inner blower access panel is removed the unit will shut down.

3. Circuit Breaker (CB8)

A 24V circuit breaker is also located in the control box. The switch provides overcurrent protection to the transformer (T1). The breaker is rated 3A at 32V. If the current exceeds this limit the breaker will trip and all unit operation will shutdown. The breaker can be manually reset by pressing the button on the face. See FIGURE 3.

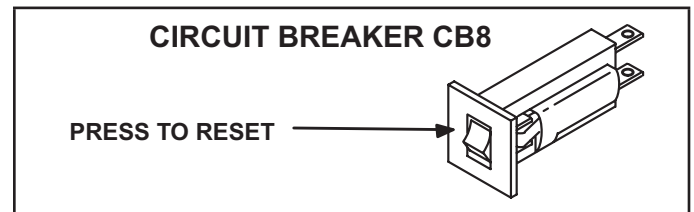

FIGURE 3

⚠ WARNING
Shock hazard. Disconnect power before servicing. Integrated control is not field repairable. If control is inoperable, simply replace entire control. Can cause injury or death. Unsafe operation will result if repair is attempted.

4. Blower Drive (See Indoor Blower Section)

5. Integrated Control (A92)

Units are equipped with a communicating enabled Sure-Light[®] two-stage, variable speed integrated control. This control is used with a communicating thermostat as part of a communicating comfort system. The control can also operate with a non-communicating conventional single or two-stage thermostat. The system consists of a ignition / blower control (FIGURE 4 and FIGURE 6) with control pin designations in TABLE 1, TABLE 2 and TABLE 3 and ignitor (FIGURE 15). The control and ignitor work in combination to ensure furnace ignition and ignitor durability. The control provides gas ignition, safety checks and indoor blower control with two-stage gas heating.

The furnace combustion air inducer, gas valve and indoor blower are controlled in response to various system inputs such as thermostat signal, pressure and limit switch signal and flame signal. The control features a seven-segment LED display, indicating furnace status (including indoor blower) and error codes. The LED flashes in single digits. The control also has two unpowered (dry) 1/4" contacts for a humidifier and a 120 volt accessory terminal. Both rated at (1) one amp each.

Electronic Ignition

At the beginning of the heat cycle the integrated control monitors the first stage and second stage combustion air inducer prove switch. The control will not begin the heating cycle if the first stage prove switch is closed (by-passed). Likewise the integrated control will not begin the second stage heating cycle if the second stage prove switch is closed, and will remain in first stage heat. However, if the second stage prove switch closes during the first stage heat pre-purge, the control will allow second stage heat. Once the first stage prove switch is determined to be open, the combustion air inducer is energized on low (first stage) heat speed. When the differential in the prove switch is great enough, the prove switch closes and a 15-second pre-purge begins.

NOTE - During abnormal conditions such as low supply voltage or low outdoor temperatures and the low fire pressure switch does not close, the combustion air inducer will switch to high fire. After a 15 second pre-purge the high fire pressure switch will close and the unit will begin operation on high fire. After 10 to 20 seconds of high fire operation the unit will switch to low fire

After the 15-second pre-purge period, the SureLight® ignitor warms up for 20 seconds after which the gas valve opens for a 4-second trial for ignition. The ignitor remains energized during the trial until flame is sensed. If ignition is not proved during the 4-second period, the control will try four more times with an inter purge and warm-up time between trials of 35 seconds. After a total of five trials for ignition (including the initial trial), the control goes into Watchguard- Flame Failure mode. After a 60-minute reset period, the control will begin the ignition sequence again.

Two Stage Operation / Thermostat Selection DIP Switch

The control can be utilized in two modes: SINGLE-STAGE thermostat or TWO-STAGE thermostat. The thermostat selection is made using a DIP switch and must be positioned for the particular application. DIP switch 1, labeled T^hSTAT HEAT STAGE is factory-set in the OFF position for use with a two-stage thermostat. Move the DIP switch to ON for use with a single stage thermostat.

While in the single-stage thermostat mode, the burners will always fire on first-stage heat. The combustion air inducer will operate on low speed and indoor blower will operate on low heat speed. The unit will switch to second stage heat after a "recognition period". DIP switch 2, labeled SECOND STAGE DELAY, is factory set in the OFF position for a 7 minute recognition period. The switch can be moved to the ON position for a 12 minute recognition period, after which time the unit will switch to second-stage heat. While in the two-stage thermostat mode, the burners will fire on first-stage heat. The combustion air inducer will operate on low speed and indoor blower will operate on low heat speed. The unit will switch to second-stage heat on call from the indoor thermostat. If there is a simultaneous call for first and second stage heat, the unit will fire an first stage heat and switch to second stage heat after 30 seconds of operation. See Sequence of Operation flow charts in the back of this manual for more detail.

TABLE 1

SureLight® Control 5 Pin Terminal Designation

Pin #	Function
1	Ignitor
2	Combustion Air Inducer High Speed
3	Combustion Air Inducer Low Speed
4	Combustion Air Inducer Neutral
5	Ignitor Neutral

TABLE 2

SureLight® Control 12 Pin Terminal Designation

Pin #	Function
1	Gas Valve Second Stage
2	Second Stage Prove Switch
3	Rollout Switch In
4	Ground
5	24V Hot
6	Primary Limit In
7	Gas Valve First Stage
8	Gas Valve Common
9	24V Neutral
10	Ground
11	Rollout Switch Out
12	First Stage Prove Switch

TABLE 3

SureLight® Control 6 Pin Terminal Designation

Pin #	Function
1	Data Input From Motor
2	Common
3	Not Used
4	Data Output To Motor
5	5 Volt Bias Supply
6	Not Used

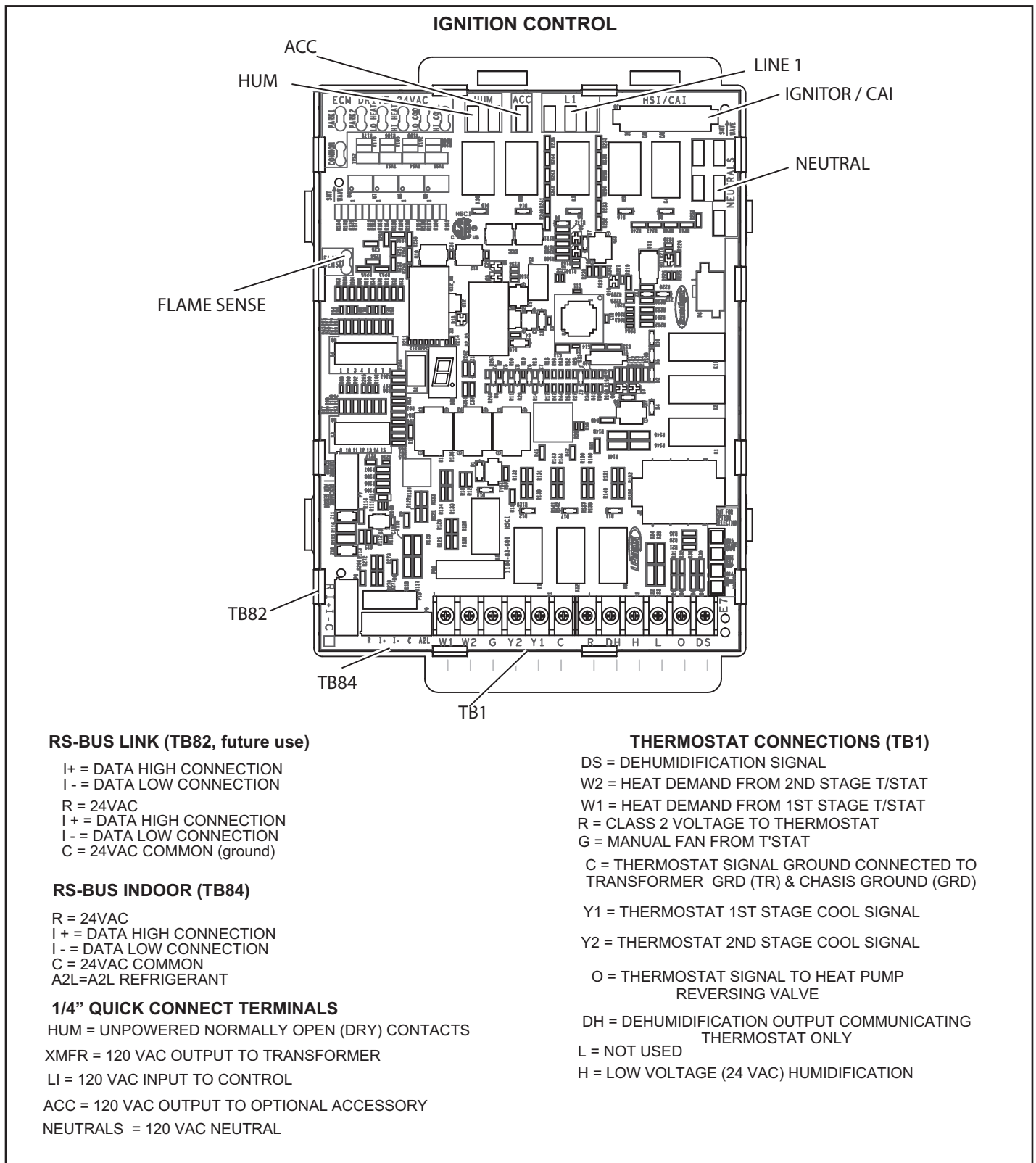

RS-BUS LINK (TB82, future use)

- I+ = DATA HIGH CONNECTION
- I- = DATA LOW CONNECTION
- R = 24VAC
- I+ = DATA HIGH CONNECTION
- I- = DATA LOW CONNECTION
- C = 24VAC COMMON (ground)

RS-BUS INDOOR (TB84)

- R = 24VAC
- I+ = DATA HIGH CONNECTION
- I- = DATA LOW CONNECTION
- C = 24VAC COMMON
- A2L=A2L REFRIGERANT

1/4" QUICK CONNECT TERMINALS

- HUM = UNPOWERED NORMALLY OPEN (DRY) CONTACTS
- XMFR = 120 VAC OUTPUT TO TRANSFORMER
- LI = 120 VAC INPUT TO CONTROL
- ACC = 120 VAC OUTPUT TO OPTIONAL ACCESSORY
- NEUTRALS = 120 VAC NEUTRAL

THERMOSTAT CONNECTIONS (TB1)

- DS = DEHUMIDIFICATION SIGNAL
- W2 = HEAT DEMAND FROM 2ND STAGE T/STAT
- W1 = HEAT DEMAND FROM 1ST STAGE T/STAT
- R = CLASS 2 VOLTAGE TO THERMOSTAT
- G = MANUAL FAN FROM T'STAT
- C = THERMOSTAT SIGNAL GROUND CONNECTED TO TRANSFORMER GRD (TR) & CHASIS GROUND (GRD)
- Y1 = THERMOSTAT 1ST STAGE COOL SIGNAL
- Y2 = THERMOSTAT 2ND STAGE COOL SIGNAL
- O = THERMOSTAT SIGNAL TO HEAT PUMP REVERSING VALVE
- DH = DEHUMIDIFICATION OUTPUT COMMUNICATING THERMOSTAT ONLY
- L = NOT USED
- H = LOW VOLTAGE (24 VAC) HUMIDIFICATION

FIGURE 4

INTEGRATED CONTROL CONFIGURATION GUIDE TYPICAL

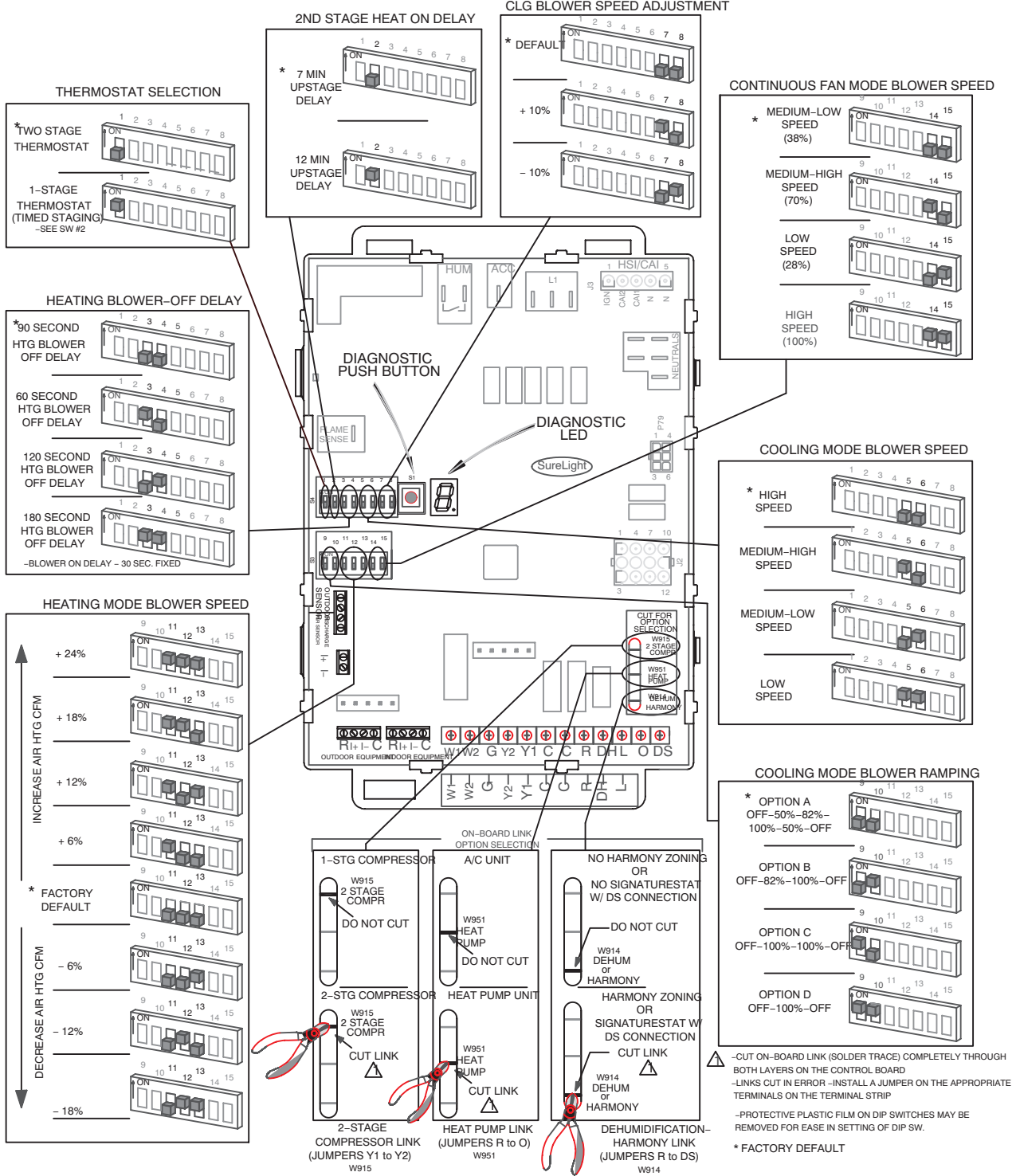

FIGURE 5

Ignition Control 107045-XX Diagnostic Modes

Display	Action (when button is released)
No change (idle)*	Remain in idle mode
Solid "E"	Enter diagnostic recall mode
Solid "U"	Discharge Air Installed
Solid "F"	Enter flame signal mode
Solid "P" (variable speed only)	Program unit capacity size (Unit Code)
Two horizontal lines	soft disable

* No change implies the display will continue to show whatever is currently being displayed for normal operation (blinking decimal, active error code, heat state, etc.)

Diagnostic LED

The seven-segment diagnostic LED displays operating status, target airflow, error codes and other information. The table beginning on the next page lists diagnostic LED codes.

Diagnostic Push Button

The diagnostic push button is located adjacent to the seven-segment diagnostic LED. This button is used to enable the Error Code Recall "E" mode and the Flame Signal "F" mode. Press the button and hold it to cycle through a menu of options. Every five seconds a new menu item will be displayed. When the button is released, the displayed item will be selected. Once all items in the menu have been displayed, the menu resumes from the beginning until the button is released.

Error Code Recall Mode

Select "E" from the menu to access the most recent 10 error codes. Select "c" from the Error Code Recall menu to clear all error codes. Button must be pressed a second time while "c" is flashing to confirm command to delete codes. Press the button until a solid "≡" is displayed to exit the Error Code Recall mode.

Flame Signal Mode

Select "F" from the menu to access the flame signal mode. The integrated control will display the flame current on 7 segment LED in micro amps (uA).

Flame signal mode is exited after any of the following:

- Power is reset
- Pressing and holding push button until 3 horizontal lines "≡" are displayed
- 10 minutes after entering the flame sense mode.

Program Unit Capacity/Size Mode

After the "P" is selected (by releasing the push button) the integrated control will start flashing the "P" on display for 90 seconds. If push button is pressed again and held during that time, the control will start to display characters corresponding to different variable speed furnace models for 3 seconds each. While the wanted character-model is displayed push button has to be released. Selected option will flash display for 10 seconds and during that time push button has to be pressed and held for 5 seconds. Once control accepts new setting it will store data in non-volatile memory and reset itself. If 10 seconds expires or push button is held less than 5 seconds, control will exit field test mode and go into idle without changing programming the unit size.

Soft Disable

Soft disabling is when thermostat finds a device on the BUS that it does not recognize and the thermostat sends a the device a message to be in soft disabling mode until properly configured. Two horizontal bars will display.

Steps to follow if the damper control module is displaying the soft disable code.

- 1 - Confirm proper wiring between all devices (thermostat, damper control module, indoor and outdoor).
- 2 - Cycle power to the control that is displaying the soft disable code.
- 3 - Put the room thermostat through set up.
- 4 - Go to setup / system devices / thermostat / edit / then push reset.
- 5 - Go to setup / system devices / thermostat / edit / then push resetAll.

Ignition Control 107045-XX Diagnostic Modes

Code	Diagnostic Codes/Status of Equipment	Action Required to Clear and Recover
.	Idle mode (Decimal blinks at 1 Hertz -- 0.5 second ON, 0.5 second OFF).	
A	Cubic feet per minute (cfm) setting for indoor blower (1 second ON, 0.5 second OFF) / cfm setting for current mode displayed.	
C	Cooling stage (1 second ON, 0.5 second OFF) / 1 or 2 displayed / Pause / cfm setting displayed / Pause / Repeat codes).	
d	Dehumidification mode (1 second ON) / 1 second OFF) / cfm setting displayed / Pause / Repeat Codes).	
h	Heat pump stage (1 second ON, 0.5 second OFF) / % of input rate displayed / Pause / cfm setting / Pause / Repeat codes.	
H	Gas Heat Stage (1 second ON, 0.5 second OFF) / 1 or 2 displayed / Pause / cfm setting displayed / Pause / Repeat codes. Blinking during ignition.	
dF	Defrost mode.	
U	Discharge Air Temperature	
E000	No error in memory	
E105	Device communication problem - No other devices on RS BUS (Communication system).	
E110	Low line voltage.	Line Voltage Low (Voltage lower than nameplate rating). Check power line voltage and correct. Alarm clears 5 seconds after fault recovered.
E111	Low line voltage.	Reverse line power voltage wiring. System resumes normal operation 5 seconds after fault recovered.
E112	Ground not detected	System shuts down. Provide proper earth ground. System resumes normal operation 5 seconds after fault recovered.
E113	High line voltage.	Line Voltage High (Voltage higher than nameplate rating). Provide power voltage within proper range. System resumes normal operation 5 seconds after fault recovered.
E114	Line voltage frequency out-of-range.	No 60 Hertz Power. Check voltage and line power frequency. Correct voltage and frequency problems. System resumes normal operation 5 seconds after fault recovered.
E115	Low 24V - Control will restart if the error recovers.	24-Volt Power Low (Range is 18 to 30 volts). Check and correct voltage. Check for additional power-robbing equipment connected to system. May require installation of larger VA transformer to be installed in furnace / air handler. Clears after fault recovered.
E117	Poor ground detected (Warning only)	Provide proper grounding for unit. Check for proper earth ground to the system. Warning only will clear 30 seconds after fault recovered.
E120	Unresponsive device. Communication only.	Usually caused by delay in outdoor unit responding to indoor unit polling. Recycle power. Check all wiring connections. Cleared after unresponsive device responds to any inquiry.

Ignition Control 107045-XX Diagnostic Modes

Code	Diagnostic Codes/Status of Equipment	Action Required to Clear and Recover
E124	Active communicating thermostat signal missing for more than 3 minutes.	Equipment lost communication with the thermostat. Check four wiring connections, ohm wires and cycle power at the thermostat. Alert stops all services and waits for heartbeat message from thermostat (subnet controller). Cleared after valid thermostat (subnet controller) message is received.
E125	Control failed self-check, internal error, failed hardware. Will restart if error recovers. Integrated control not communicating. Covers hardware errors (flame sense circuit faults, pin shorts, etc.).	Hardware problem on the control. Cycle power on control. Replace if problem prevents service and is persistent. Critical alert. Cleared 300 seconds after fault recovered.
E131	Corrupted control parameters (Verify configuration of system). Communicating only.	Reconfigure the system. Replace control if heating or cooling is not available. Only applicable in the communicating mode, not in startup. Exit from Commissioning and Execute 'Set Factory Default mode Control will still operate on default parameter settings
E150	A2L Refigerant leak alarm	
E151	A2L Sensor fault (sensor problem) (communication mode only)	
E180	Outdoor air temperature sensor failure. Only shown if shorted or out-of-range.	Compare outdoor sensor resistance to temperature/ resistance charts in unit installation instructions. Replace sensor pack if necessary. At beginning of (any) configuration, furnace or air handler control will sense outdoor air and discharge air temperature sensor(s). If detected (reading in range), appropriate feature will be set as 'installed' and that could be seen in 'About' screen. In normal operation after control recognizes sensors, alarm will be sent if valid temperature reading is lost. To get rid of setting and alarm, redo configuration and make sure that temperature sensor is marked as 'not installed' in Indoor Unit 'About' screen. When Indoor unit control is replaced, thermostat will 'tell' new control if temperature sensor is in system or not. Clears 30 seconds after fault recovered.
E200	Hard lockout - Rollout circuit open or previously open.	Correct cause of rollout trip, or replace flame rollout switch. Test furnace operation. Cleared after fault recovered.
E201	Indoor blower communication failure - Unable to communicate with blower motor.	Indoor blower communication failure (including power outage). Lost communication with indoor blower motor. Possible causes: motor not powered, loose wiring. Problem may be on control or motor side. Cleared after fault recovered.
E202	Indoor blower motor mis-match - Indoor motor horsepower does not match unit capacity.	Incorrect appliance capacity code selected. Check for proper configuring under: Unit Size Codes for Furnace/Air Handler on configuration guide or in installation instructions. Cleared after the correct match is detected following a reset. (Remove thermostat from system while applying power and reprogramming.)
E203	Appliance capacity / size is NOT programmed. Invalid unit codes refer to configuration flow chart.	No appliance capacity code selected. Check for proper configuring under: Unit Size Codes for Furnace on configuration guide or in installation instructions. Critical Alert. Cleared after valid unit code is read following a reset. (Remove thermostat from system while applying power and reprogramming.)
E204	Gas valve mis-wired.	Check gas valve operation and wiring. Clears when repaired.
E205	Gas valve control relay contact shorted.	Check wiring on control and gas valve. If wiring is correct, replace control.

Ignition Control 107045-XX Diagnostic Modes

Code	Diagnostic Codes/Status of Equipment	Action Required to Clear and Recover
E206	Gas valve second-stage relay failure	Furnace will operate on 1st stage for remainder of the heating demand. Will clear after fault recovered. If unable to operate 2nd stage, replace control.
E207	Hot surface ignitor sensed open.	Measure resistance of hot surface ignitor. Replace if open or not within specified range found in IOM. Resumes normal operation after fault is cleared.
E223	Low pressure switch failed open.	Check pressure (inches w.c.) of low pressure switch closing on heat call. Measure operating pressure (inches w.c.). Inspect vent and combustion air inducer for correct operation and restriction. Resumes normal operation after fault is cleared
E224	Low pressure switch failed closed.	Check operation of low pressure switch to see if it is stuck closed on heat call longer than 150 seconds. Measure operating pressure (inches w.c.). Inspect vent and combustion air inducer for correct operation and restriction. Resumes normal operation after fault is cleared.
E225	High pressure switch failed open.	Check pressure (inches w.c.) of high pressure switch closing on heat call. Measure operating pressure (inches w.c.). Inspect vent and combustion air inducer for correct operation and restriction. Resumes normal operation after fault is cleared.
E226	High pressure switch failed closed	Check operation of high pressure switch closing on heat call. Measure operating pressure (inches w.c.). Inspect vent and combustion air inducer for correct operation and restriction. Resumes normal operation after fault is cleared.
E227	Low pressure switch open during trial for ignition or run mode.	Check pressure (inches w.c.) of low pressure switch closing on heat call. Measure operating pressure (inches w.c.). Inspect vent and combustion air inducer for correct operation and restriction. Resumes normal operation after fault is cleared.
E228	Combustion air inducer calibration failure	Unable to perform pressure switch calibration. Check vent system and pressure switch wiring connections. Resumes normal operation after fault is cleared.
E229	Ignition on high fire	IFC switched to high fire ignition because low fire pressure switch did not close in allowed time. No action is needed.
E240	Low flame current - Run mode.	Check micro-amperes of flame sensor using control diagnostics or field-installed mode. Clean or replace sensor. Measure voltage of neutral to ground to ensure good unit ground. Alert clears after current heat call has been completed.
E241	Flame sensed out of sequence - Flame still present.	Shut off gas. Check for gas valve leak. Replace, if necessary. Alert clears when fault is recovered.
E250	Limit switch circuit open.	Check for proper firing rate on furnace. Ensure there is no blockage in heater. Check for proper air flow. If limit not closed within 3 minutes, unit will go into 1-hour soft lockout. Resumes normal operation after fault is cleared.
E252	Discharge air temperature too high (gas heat only).	Check temperature rise, air flow and input rate. Cleared when heat call is finished.
E270	Soft lockout - Exceeded maximum number of retries. No flame current sensed.	Check for proper gas flow. Ensure that ignitor is lighting burner. Check flame sensor current. Clears when heat call finishes successfully.

Ignition Control 107045-XX Diagnostic Modes

Code	Diagnostic Codes/Status of Equipment	Action Required to Clear and Recover
E271	Soft lockout - Exceeded maximum number of retries. Last retry failed due to the pressure switch opening.	Check pressure (inches w.c.) of low pressure switch closing on heat call. Measure operating pressure (inches w.c.). Inspect vent and combustion air inducer for correct operation and restriction. Clears when heat call finishes successfully.
E272	Soft lockout - Exceeded maximum number of recycles. Last recycle due to the pressure switch opening.	Check operation of low pressure switch to see if it is stuck closed on heat call. Check pressure (inches w.c.) of high pressure switch closing on heat call. Measure operating pressure (inches w.c.). Inspect vent and combustion air inducer for correct operation and restriction. Clears when heat call finishes successfully.
E273	Soft lockout - Exceeded maximum number of recycles. Last recycle due to flame failure.	Check micro-amperes of flame sensor using control diagnostics or field-installed mode. Clean or replace sensor. Measure voltage of neutral to ground to ensure good unit ground. Clears when heat call finishes successfully.
E274	Soft lockout - Exceeded maximum number of recycles. Last recycle failed due to the limit circuit opening or limit remained open longer than 3 minutes	Shut down system. 1-hour soft lockout. Check firing rate and air flow. Check for blockage. Clears when heat call finishes successfully.
E275	Soft lockout - Flame sensed out of sequence. Flame signal is gone.	Shut off gas. Check for gas valve leak. 1-hour soft lockout. Clears when flame has been proven stable.
E290	Ignitor circuit fault - Failed ignitor or triggering circuitry.	Measure resistance of hot surface ignitor. Replace if open or not within specifications. 1-hour soft lockout. Clears when flame has been proven stable.
E292	Indoor blower motor unable to start due to obstructed wheel, seized bearings.	Indoor blower motor unable to start (seized bearing, stuck wheel, etc.). Replace motor or wheel if assembly does not operate or meet performance standards. 1-hour soft lockout. Clears after circulator successfully starts.
E295	Indoor blower motor temperature is too high.	Indoor blower motor over temperature (motor tripped on internal protector). Check motor bearings and amps. Replace if necessary. Cleared after blower demand is satisfied.
E310	Discharge error temperature sensor failure. Only shown if shorted or out of range.	Compare outdoor sensor resistance to temperature/ resistance charts in installation instructions. Replace sensor if necessary. Cleared in Communicating mode: 30 seconds after fault recovered. In Non-Communicating mode: Cleared after the current heat call is completed.
E311	Heat rate reduced to match indoor blower air flow.	Warning Only. Furnace blower in cutback mode due to restricted airflow. Reduce firing rate every 60 seconds to match available CFM. Check filter and duct system. To clear, replace filter if needed or repair/ add duct. 2-stage controls will reduce firing rate to 1st stage. Clears when heat call finishes successfully.

Ignition Control 107045-XX Diagnostic Modes

Code	Diagnostic Codes/Status of Equipment	Action Required to Clear and Recover
E312	Restricted air flow in cooling or continuous fan mode is lower than cfm setting.	Warning Only. Restricted airflow - Indoor blower is running at a reduced CFM (Cutback Mode - The variable speed motor has pre-set speed and torque limiters to protect the motor from damage caused by operating outside of design parameters (0 to 0.8" W.C.. total external static pressure). Check filter and duct system. To clear, replace filter if needed or repair/add duct. Cleared after the current service demand is satisfied.
E313	Indoor or outdoor unit capacity mismatch. Communication only.	Incorrect indoor/outdoor capacity code selected. Check for proper configuring in installation instructions. Alarm is just a warning. The system will operate, but might not meet efficiency and capacity parameters. Alarm will clear when commissioning is exited. Cleared after commissioning is complete.
E334	Relay "Y1" stuck on interated control.	Replace integrated control.
E345	Relay O Failure	
E347	No 24 Volt output on Y1 of "integrated control" with non communicating outdoor unit.	Operation stopped. Y1 relay / Stage 1 failed. (Pilot relay contacts did not close or the relay coil did not energize; no input back to IFC chip). Critical Alert. Cleared after reset and Y1 input sensed.
E348	No 24 Volt output on Y2 of "integrated control" with non?communicating outdoor unit.	Y2 relay / Stage 2 failed. (Pilot relay contacts did not close or the relay coil did not energize; no input back to IFC chip). Critical Alert. Cleared after reset and Y1 input sensed.
E370	Interlock switch sensed open for 2 minutes.	Control sees the loss of 24VAC for 2 minutes. Terminate all services and wait for interlock switch to close. The alarm will clear when 24VAC is continuously sensed on DS terminal for a minimum of 10 seconds or on a power reset.

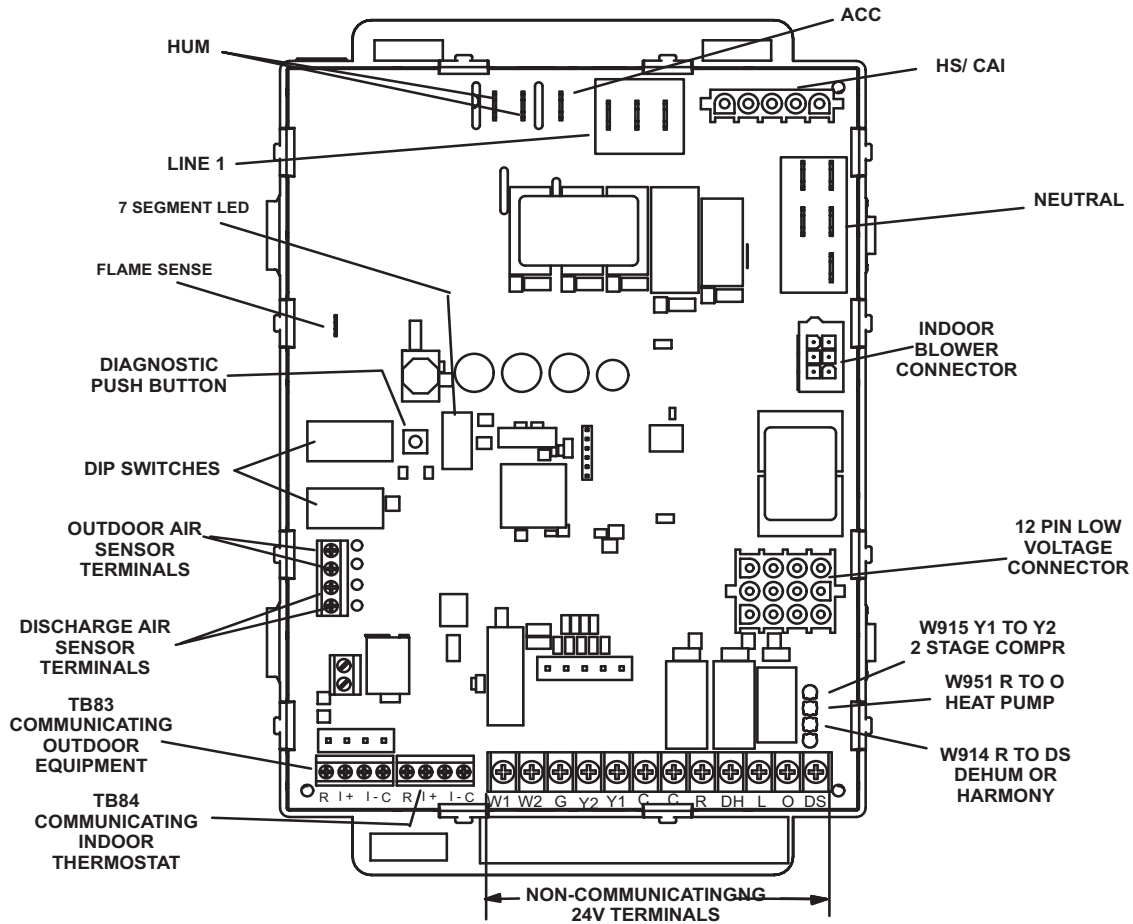

RS-BUS LINK (TB82, future use)

I+ = DATA HIGH CONNECTION
I- = DATA LOW CONNECTION

RS-BUS OUTDOOR (TB83)

R = 24VAC
I+ = DATA HIGH CONNECTION
I- = DATA LOW CONNECTION
C = 24VAXC COMMON

RS-BUS INDOOR (TB84)

R = 24VAC
I+ = DATA HIGH CONNECTION
I- = DATA LOW CONNECTION
C = 24VAXC COMMON

1/4" QUICK CONNECT TERMINALS

HUM = UNPOWERED NORMALLY OPEN (DRY) CONTACTS
XMFR = 120 VAC OUTPUT TO TRANSFORMER
LI = 120 VAC INPUT TO CONTROL
ACC = 120 VAC OUTPUT TO OPTIONAL ACCESSORY
NEUTRALS = 120 VAC NEUTRAL

THERMOSTAT CONNECTIONS (TB1)

DS = DEHUMIDIFICATION SIGNAL
W2 = HEAT DEMAND FROM 2ND STAGE T/STAT
W1 = HEAT DEMAND FROM 1ST STAGE T/STAT
R = CLASS 2 VOLTAGE TO THERMOSTAT
G = MANUAL FAN FROM T/STAT
C = THERMOSTAT SIGNAL GROUND CONNECTED TO TRANSFORMER GRD (TR) & CHASIS GROUND (GRD)
Y1 = THERMOSTAT 1ST STAGE COOL SIGNAL
Y2 = THERMOSTAT 2ND STAGE COOL SIGNAL
O = THERMOSTAT SIGNAL TO HEAT PUMP REVERSING VALVE
DH = DEHUMIDIFICATION OUTPUT COMMUNICATING THERMOSTAT ONLY
L = USE ONLY WITH A COMMUNICATING THERMOSTAT AND A NON-COMMUNICATING OUTDOOR UNIT

FIGURE 6

Ignition Control 103130-XX Diagnostic Modes

Display	Action (when button released)
No change (idle)*	Remain in idle mode
Solid "E"	Enter diagnostic recall mode
Solid "D"	Discharge Air Installed
Solid "F"	Enter flame signal mode
Solid "P" (variable speed only)	Program unit capacity/size (Unit Code)
Two horizontal bars =	Soft disable

* No change implies the display will continue to show whatever is currently being displayed for normal operation (blinking decimal, active error code, heat state, etc..)

Diagnostic LED

The seven-segment diagnostic LED displays operating status, target airflow, error codes and other information. The table beginning on Page 9 lists diagnostic LED codes.

Diagnostic Push Button

The diagnostic push button is located adjacent to the seven-segment diagnostic LED. This button is used to enable the Error Code Recall "E" mode and the Flame Signal "F" mode. Press the button and hold it to cycle through a menu of options. Every five seconds a new menu item will be displayed. When the button is released, the displayed item will be selected. Once all items in the menu have been displayed, the menu resumes from the beginning until the button is released.

Error Code Recall Mode

Select "E" from the menu to access the most recent 10 error codes. Select "c" from the Error Code Recall menu to clear all error codes. Button must be pressed a second time while "c" is flashing to confirm command to delete codes. Press the button until a solid "≡" is displayed to exit the Error Code Recall mode.

Flame Signal Mode

Select "F" from the menu to access the flame signal mode. The integrated control will display the flame current on 7 segment LED in micro amps (uA).

- Flame signal mode is exited after any of the following: Power is reset
- Pressing and holding push button until 3 horizontal lines "≡" are displayed
- 10 minutes after entering the flame sense mode.

Program Unit Capacity/Size Mode

After the "P" is selected (by releasing the push button) the integrated control will start flashing the "P" on display for 90 seconds. If push button is pressed again and held during that time, the control will start to display characters corresponding to different variable speed furnace models for 3 seconds each. While the wanted character-model is displayed push button has to be released. Selected option will flash display for 10 seconds and during that time push button has to be pressed and held for 5 seconds. Once control accepts new setting it will store data in non-volatile memory and reset itself. If 10 seconds expires or push button is held less than 5 seconds, control will exit field test mode and go into idle without changing programming the unit size.

Soft Disable

Soft disabling is when thermostat finds a device on the BUS that it does not recognize and the thermostat sends a the device a message to be in soft disabling mode until properly configured. Two horizontal bars will display.

Steps to follow if the damper control module is displaying the soft disable code.

- 1 - Confirm proper wiring between all devices (thermostat, damper control module, indoor and outdoor).
- 2 - Cycle power to the control that is displaying the soft disable code.
- 3 - Put the room thermostat through set up.
- 4 - Go to **setup / system devices / thermostat / edit** / then push reset.
- 5 - Go to **setup / system devices / thermostat / edit** / then push **resetAll**.

Ignition Control 103130-XX Diagnostic Codes

Code	Diagnostic Codes/Status of Equipment	Action Required to Clear and Recover
.	Idle mode (Decimal blinks at 1 Hertz -- 0.5 second ON, 0.5 second OFF).	
A	Cubic feet per minute (cfm) setting for indoor blower (1 second ON, 0.5 second OFF) / cfm setting for current mode displayed.	
C	Cooling stage (1 second ON, 0.5 second OFF) / 1 or 2 displayed / Pause / cfm setting displayed / Pause / Repeat codes).	
d	Dehumidification mode (1 second ON) / 1 second OFF) / cfm setting displayed / Pause / Repeat Codes).	
h	Heat pump stage (1 second ON, 0.5 second OFF) / % of input rate displayed / Pause / cfm setting / Pause / Repeat codes.	
H	Gas Heat Stage (1 second ON, 0.5 second OFF) / 1 or 2 displayed / Pause / cfm setting displayed / Pause / Repeat codes. Blinking during ignition.	
dF	Defrost mode.	
U	Discharge Air Temperature	
E105	Device communication problem - No other devices on RS BUS (Communication system).	Equipment is unable to communicate. Indicates numerous message errors. In most cases errors are related to electrical noise. Make sure high voltage power is separated from RSBus. Check for miswired and/or loose connections between the stat, indoor unit and outdoor unit. Check for a high voltage source of noise close to the system. Fault clears after communication is restored.
E110	Low line voltage.	Line Voltage Low (Voltage lower than nameplate rating). Check power line voltage and correct. Alarm clears 5 seconds after fault recovered.
E111	Low line voltage.	Reverse line power voltage wiring. System resumes normal operation 5 seconds after fault recovered.
E112	Ground not detected	System shuts down. Provide proper earth ground. System resumes normal operation 5 seconds after fault recovered.
E113	High line voltage.	Line Voltage High (Voltage higher than nameplate rating). Provide power voltage within proper range. System resumes normal operation 5 seconds after fault recovered.
E114	Line voltage frequency out-of-range.	No 60 Hertz Power. Check voltage and line power frequency. Correct voltage and frequency problems. System resumes normal operation 5 seconds after fault recovered.
E115	Low 24V - Control will restart if the error recovers.	24-Volt Power Low (Range is 18 to 30 volts). Check and correct voltage. Check for additional power-robbing equipment connected to system. May require installation of larger VA transformer to be installed in furnace / air handler. Clears after fault recovered.
E116	High 24V.	24 Volt Power High (Range is 18 to 30 volts). Check and correct voltage. Check for proper line voltage (120V, 240V, etc.) to equipment. Clears when control senses proper voltage.
E117	Poor ground detected (Warning only)	Provide proper grounding for unit. Check for proper earth ground to the system. Warning only will clear 30 seconds after fault recovered.
E120	Unresponsive device. Communication only.	Usually caused by delay in outdoor unit responding to indoor unit polling. Recycle power. Check all wiring connections. Cleared after unresponsive device responds to any inquiry.

Ignition Control 103130-XX Diagnostic Codes

Code	Diagnostic Codes/Status of Equipment	Action Required to Clear and Recover
E124	Active communicating thermostat signal missing for more than 3 minutes.	Equipment lost communication with the thermostat. Check four wiring connections, ohm wires and cycle power at the thermostat. Alert stops all services and waits for heartbeat message from thermostat (subnet controller). Cleared after valid thermostat (subnet controller) message is received.
E125	Control failed self-check, internal error, failed hardware. Will restart if error recovers. Integrated control not communicating. Covers hardware errors (flame sense circuit faults, pin shorts, etc.).	Hardware problem on the control. Cycle power on control. Replace if problem prevents service and is persistent. Critical alert. Cleared 300 seconds after fault recovered.
E126	Control internal communication problem.	Hardware problem on the control. Cycle power on control. Replace if problem prevents service and is persistent. Cleared 300 seconds after fault recovered.
E131	Corrupted control parameters (Verify configuration of system). Communicating only.	Reconfigure the system. Replace control if heating or cooling is not available. Only applicable in the communicating mode, not in startup. Exit from Commissioning and Execute 'Set Factory Default mode Control will still operate on default parameter settings
E180	Outdoor air temperature sensor failure. Only shown if shorted or out-of range.	Compare outdoor sensor resistance to temperature/ resistance charts in unit installation instructions. Replace sensor pack if necessary. At beginning of (any) configuration, furnace or air handler control will sense outdoor air and discharge air temperature sensor(s). If detected (reading in range), appropriate feature will be set as 'installed' and that could be seen in 'About' screen. In normal operation after control recognizes sensors, alarm will be sent if valid temperature reading is lost. To get rid of setting and alarm, redo configuration and make sure that temperature sensor is marked as 'not installed' in Indoor Unit 'About' screen. When Indoor unit control is replaced, thermostat will 'tell' new control if temperature sensor is in system or not. Clears 30 seconds after fault recovered.
E200	Hard lockout - Rollout circuit open or previously open.	Correct cause of rollout trip, or replace flame rollout switch. Test furnace operation. Cleared after fault recovered.
E201	Indoor blower communication failure - Unable to communicate with blower motor.	Indoor blower communication failure (including power outage). Lost communication with indoor blower motor. Possible causes: motor not powered, loose wiring. Problem may be on control or motor side. Cleared after fault recovered.
E202	Indoor blower motor mis-match - Indoor motor horsepower does not match unit capacity.	Incorrect appliance capacity code selected. Check for proper configuring under: Unit Size Codes for Furnace/Air Handler on configuration guide or in installation instructions. Cleared after the correct match is detected following a reset. (Remove thermostat from system while applying power and reprogramming.)
E203	Appliance capacity / size is NOT programmed. Invalid unit codes refer to configuration flow chart.	No appliance capacity code selected. Check for proper configuring under: Unit Size Codes for Furnace on configuration guide or in installation instructions. Critical Alert. Cleared after valid unit code is read following a reset. (Remove thermostat from system while applying power and reprogramming.)
E204	Gas valve mis-wired.	Check gas valve operation and wiring. Clears when repaired.
E205	Gas valve control relay contact shorted.	Check wiring on control and gas valve. If wiring is correct, replace control.

Ignition Control 103130-XX Diagnostic Codes

Code	Diagnostic Codes/Status of Equipment	Action Required to Clear and Recover
E206	Gas valve second-stage relay failure	Furnace will operate on 1st stage for remainder of the heating demand. Will clear after fault recovered. If unable to operate 2nd stage, replace control.
E207	Hot surface ignitor sensed open.	Measure resistance of hot surface ignitor. Replace if open or not within specified range found in IOM. Resumes normal operation after fault is cleared.
E223	Low pressure switch failed open.	Check pressure (inches w.c.) of low pressure switch closing on heat call. Measure operating pressure (inches w.c.). Inspect vent and combustion air inducer for correct operation and restriction. Resumes normal operation after fault is cleared
E224	Low pressure switch failed closed.	Check operation of low pressure switch to see if it is stuck closed on heat call longer than 150 seconds. Measure operating pressure (inches w.c.). Inspect vent and combustion air inducer for correct operation and restriction. Resumes normal operation after fault is cleared.
E225	High pressure switch failed open.	Check pressure (inches w.c.) of high pressure switch closing on heat call. Measure operating pressure (inches w.c.). Inspect vent and combustion air inducer for correct operation and restriction. Resumes normal operation after fault is cleared.
E226	High pressure switch failed closed	Check operation of high pressure switch closing on heat call. Measure operating pressure (inches w.c.). Inspect vent and combustion air inducer for correct operation and restriction. Resumes normal operation after fault is cleared.
E227	Low pressure switch open during trial for ignition or run mode.	Check pressure (inches w.c.) of low pressure switch closing on heat call. Measure operating pressure (inches w.c.). Inspect vent and combustion air inducer for correct operation and restriction. Resumes normal operation after fault is cleared.
E228	Combustion air inducer calibration failure	Unable to perform pressure switch calibration. Check vent system and pressure switch wiring connections. Resumes normal operation after fault is cleared.
E229	Ignition on high fire	IFC switched to high fire ignition because low fire pressure switch did not close in allowed time. No action is needed.
E240	Low flame current - Run mode.	Check micro-amperes of flame sensor using control diagnostics or field-installed mode. Clean or replace sensor. Measure voltage of neutral to ground to ensure good unit ground. Alert clears after current heat call has been completed.
E241	Flame sensed out of sequence - Flame still present.	Shut off gas. Check for gas valve leak. Replace, if necessary. Alert clears when fault is recovered.
E250	Limit switch circuit open.	Check for proper firing rate on furnace. Ensure there is no blockage in heater. Check for proper air flow. If limit not closed within 3 minutes, unit will go into 1-hour soft lockout. Resumes normal operation after fault is cleared.
E252	Discharge air temperature too high (gas heat only).	Check temperature rise, air flow and input rate. Cleared when heat call is finished.
E270	Soft lockout - Exceeded maximum number of retries. No flame current sensed.	Check for proper gas flow. Ensure that ignitor is lighting burner. Check flame sensor current. Clears when heat call finishes successfully.

Ignition Control 103130-XX Diagnostic Codes

Code	Diagnostic Codes/Status of Equipment	Action Required to Clear and Recover
E271	Soft lockout - Exceeded maximum number of retries. Last retry failed due to the pressure switch opening.	Check pressure (inches w.c.) of low pressure switch closing on heat call. Measure operating pressure (inches w.c.). Inspect vent and combustion air inducer for correct operation and restriction. Clears when heat call finishes successfully.
E272	Soft lockout - Exceeded maximum number of recycles. Last recycle due to the pressure switch opening.	Check operation of low pressure switch to see if it is stuck closed on heat call. Check pressure (inches w.c.) of high pressure switch closing on heat call. Measure operating pressure (inches w.c.). Inspect vent and combustion air inducer for correct operation and restriction. Clears when heat call finishes successfully.
E273	Soft lockout - Exceeded maximum number of recycles. Last recycle due to flame failure.	Check micro-amperes of flame sensor using control diagnostics or field-installed mode. Clean or replace sensor. Measure voltage of neutral to ground to ensure good unit ground. Clears when heat call finishes successfully.
E274	Soft lockout - Exceeded maximum number of recycles. Last recycle failed due to the limit circuit opening or limit remained open longer than 3 minutes	Shut down system. 1-hour soft lockout. Check firing rate and air flow. Check for blockage. Clears when heat call finishes successfully.
E275	Soft lockout - Flame sensed out of sequence. Flame signal is gone.	Shut off gas. Check for gas valve leak. 1-hour soft lockout. Clears when flame has been proven stable.
E276	Watchguard calibration failure.	Unable to perform pressure switch calibration. Check vent system and pressure switch wiring connections. 1-hour soft lockout. Clears when calibration has finished successfully.
E290	Ignitor circuit fault - Failed ignitor or triggering circuitry.	Measure resistance of hot surface ignitor. Replace if open or not within specifications. 1-hour soft lockout. Clears when flame has been proven stable.
E291	Heat air flow restricted below the minimum.	Check for dirty filter and air flow restriction. Check blower performance. 1-hour soft lockout. Cleared when heat call finishes successfully.
E292	Indoor blower motor unable to start due to obstructed wheel, seized bearings.	Indoor blower motor unable to start (seized bearing, stuck wheel, etc.). Replace motor or wheel if assembly does not operate or meet performance standards. 1-hour soft lockout. Clears after circulator successfully starts.
E294	Combustion air inducer over current.	Check combustion blower bearings, wiring and amps. Replace if does not operate or does not meet performance standards. Clears after inducer current is sensed to be in-range after the ignition following the soft lockout or reset.
E295	Indoor blower motor temperature is too high.	Indoor blower motor over temperature (motor tripped on internal protector). Check motor bearings and amps. Replace if necessary. Cleared after blower demand is satisfied.
E310	Discharge error temperature sensor failure. Only shown if shorted or out of range.	Compare outdoor sensor resistance to temperature/ resistance charts in installation instructions. Replace sensor if necessary. Cleared in Communicating mode: 30 seconds after fault recovered. In Non-Communicating mode: Cleared after the current heat call is completed.
E311	Heat rate reduced to match indoor blower air flow.	Warning Only. Furnace blower in cutback mode due to restricted airflow. Reduce firing rate every 60 seconds to match available CFM. Check filter and duct system. To clear, replace filter if needed or repair/ add duct. 2-stage controls will reduce firing rate to 1st stage. Clears when heat call finishes successfully.

Ignition Control 103130-XX Diagnostic Codes

Code	Diagnostic Codes/Status of Equipment	Action Required to Clear and Recover
E312	Restricted air flow in cooling or continuous fan mode is lower than cfm setting.	Warning Only. Restricted airflow - Indoor blower is running at a reduced CFM (Cutback Mode - The variable speed motor has pre-set speed and torque limiters to protect the motor from damage caused by operating outside of design parameters (0 to 0.8" W.C.. total external static pressure). Check filter and duct system. To clear, replace filter if needed or repair/add duct. Cleared after the current service demand is satisfied.
E313	Indoor or outdoor unit capacity mismatch. Communication only.	Incorrect indoor/outdoor capacity code selected. Check for proper configuring in installation instructions. Alarm is just a warning. The system will operate, but might not meet efficiency and capacity parameters. Alarm will clear when commissioning is exited. Cleared after commissioning is complete.
E331	Global network connection - Communication link problem.	For Future Use.
E334	Relay "Y1" stuck on integrated control.	Replace integrated control.
E347	No 24 Volt output on Y1 of "integrated control" with non communicating outdoor unit.	Operation stopped. Y1 relay / Stage 1 failed. (Pilot relay contacts did not close or the relay coil did not energize; no input back to IFC chip). Critical Alert. Cleared after reset and Y1 input sensed.
E348	No 24 Volt output on Y2 of "integrated control" with non communicating outdoor unit.	Y2 relay / Stage 2 failed. (Pilot relay contacts did not close or the relay coil did not energize; no input back to IFC chip). Critical Alert. Cleared after reset and Y1 input sensed.
E349	No 24 Volts between R & O on "integrated control" with non communicating outdoor unit (Dual fuel module required for heat pump application)	Configuration link R to O needs to be restored. Replace link or hardwire. Applicable in non communicating mode. Critical Alert.
E370	Interlock switch sensed open for 2 minutes.	Control sees the loss of 24VAC for 2 minutes. Terminate all services and wait for interlock switch to close. The alarm will clear when 24VAC is continuously sensed on DS terminal for a minimum of 10 seconds or on a power reset.
E400	LSOM - Compressor internal overload tripped.	Thermostat demand Y1 is present; but, compressor is not running. Check power to outdoor unit. Clears the error after current is sensed in both RUN and START sensors for at least 2 seconds, or after service is removed, or after power reset.
E401	LSOM Compressor long run cycle or low system pressure.	Compressor ran more than 18 hours to satisfy a single thermostat demand. Critical Alert. Clears the error after 30 consecutive normal run cycles or power reset. Also monitors low pressure switch trips.
E402	LSOM - Outdoor unit system pressure trip.	Discharge or suction pressure out-of-limits, or compressor overloaded. Clears the error after 4 consecutive normal compressor run cycles.
E403	LSOM - Compressor short-cycling. (Running less than 4 minutes). Outdoor unit pressure trip	Compressor runs less than 3 minutes to satisfy a thermostat demand. Clears the error after 4 consecutive normal run cycles or power reset.
E404	LSOM - Compressor rotor locked. Compressor short-cycling. (Running less than 4 minutes).	Compressor rotor locked up due to run capacitor short, bearings are seized, excessive liquid refrigerant, etc. Clears the error after 4 consecutive normal run cycles or after power reset.
E405	LSOM - Compressor open circuit.	Compressor circuit open (due to power disconnection, open fuse, etc.) Clears the error after 1 normal compressor run cycle.

Ignition Control 103130-XX Diagnostic Codes

Code	Diagnostic Codes/Status of Equipment	Action Required to Clear and Recover
E406	LSOM - Compressor open start circuit.	Required amount of current is not passing through Start current transformer. Clears the error after current is sensed in START sensor, or after power reset.
E407	LSOM - Compressor open run circuit.	Required amount of current is not passing through Run current transformer. Clears the error after current is sensed in RUN sensor, or 1 normal compressor run cycle, or after power reset.
E408	LSOM - Compressor contactor is welded.	Compressor runs continuously. Clears the error after 1 normal compressor run cycle or after power reset.
E409	LSOM - Compressor low voltage.	Secondary voltage is below 18VAC. After 10 minutes, operation is discontinued. Clears the code after voltage is higher than 20 VAC for 2 seconds or after power reset.

**Integrated Control DIP Switch Settings
Conventional Thermostat (non-communicating)**

EL297UHV units are equipped with a two-stage, variable speed integrated control. This control manages ignition timing, heating mode fan off delays and indoor blower speeds based on selections made using the control dip switches and jumpers. The control includes an internal watchdog feature which automatically resets the ignition control when it has been locked out. After one hour of continuous thermostat demand for heat, the watchdog will break and remake thermostat demand to the furnace and automatically reset the control to relight the furnace.

Note: All communicating settings are set at the communicating thermostat. See thermostat installation instruction. In a communication system all DIP switch and clippable link settings are ignored. For conventional thermostats proceed with DIP switch and clippable link settings as outlined in the following.

Heating Operation DIP Switch Settings

Switch 1 -- Thermostat Selection -- This unit may be used with either a single-stage or two-stage thermostat. The thermostat selection is made using a DIP switch which must be properly positioned for the particular application. The DIP switch is factory-positioned for use with a two-stage thermostat. If a single-stage thermostat is to be used, the DIP switch must be repositioned.

- a. Select "OFF" for two-stage heating operation controlled by a two-stage heating thermostat (factory setting);
- b. Select "ON" for two-stage heating operation controlled by a single-stage heating thermostat. This setting provides a timed delay before second-stage heat is initiated.

Switch 2 -- Second Stage Delay (Used with Single-Stage Thermostat Only) -- This switch is used to determine the second stage on delay when a single-stage thermostat is being used. The switch is factory-set in the OFF position, which provides a 7-minute delay before second-stage heat is initiated. If the switch is toggled to the ON position, it will provide a 12-minute delay before second-stage heat is initiated. This switch is only activated when the thermostat selector jumper is positioned for Single stage thermostat use.

Switches 3 and 4 -- Blower-Off Delay -- The blower-on delay of 30 seconds is not adjustable. The blower-off delay (time that the blower operates after the heating demand has been satisfied) can be adjusted by moving switches 3 and 4 on the integrated control. The unit is shipped from the factory with a blower-off delay of 90 seconds. The blower off delay affects comfort and is adjustable to satisfy individual applications. Adjust the blower off delay to achieve a supply air temperature between 90° and 110°F at the exact moment that the blower is de-energized. Longer off delay settings provide lower supply air temperatures; shorter settings provide higher supply air temperatures. TABLE 4 provides the blower off timings that will result from different switch settings.

**TABLE 4
Blower Off Delay Switch Settings**

Blower Off Delay Seconds	Switch 3	Switch 4
60	On	Off
90 (factory)	Off	Off
120	Off	On
180	On	On

Indoor Blower Operation DIP Switch Settings

Switches 5 and 6 -- Cooling Mode Blower Speed -- The unit is shipped from the factory with the dip switches positioned for high speed (4) indoor blower motor operation during the cooling mode. TABLE 5 provides the cooling mode blower speeds that will result from different switch settings. Switches 5 and 6 set the blower cfm for second-stage cool. The integrated control automatically ramps down to 70% of the second-stage cfm for first-stage cfm. Refer to tables for corresponding cfm values. See Product Specifications for more detailed blower cfm tables.

**TABLE 5
Cooling Mode Blower Speeds**

Speed	Switch 5	Switch 6
Low	On	On
Medium Low	Off	On
Medium High	On	Off
High (factory)	Off	Off

Switches 7 and 8 -- Cooling Blower Speed Adjustment

-- The unit is shipped from the factory with the dip switches positioned for NORMAL (no) adjustment. The dip switches may be positioned to adjust the blower speed by +10% or -10% to better suit the application. TABLE 6 below provides blower speed adjustments that will result from different switch settings. Refer to tables for corresponding cfm values. See Product Specifications for more detailed blower cfm tables.

**TABLE 6
Cooling Blower Speed Adjustment**

Adjustment	Switch 7	Switch 8
+10% (approx)	On	Off
Factory Default	Off	Off
-10% (approx)	Off	On

Switches 9 and 10 -- Cooling Mode Blower Speed Ramping -- Blower speed ramping may be used to enhance dehumidification performance. The switches are factory set at option A which has the greatest effect on dehumidification performance. TABLE 7 provides the cooling mode blower speed ramping options that will result from different switch settings. The cooling mode blower mode blower speed ramping options are detailed on the next page.

NOTE - In heat pump mode blower operation defaults to option c.

TABLE 7

Cooling Mode Blower Speed Ramping

Ramping	Switch 9	Switch 10
A (Factory)	Off	Off
B	Off	On
C	On	Off
D	On	On

Ramping Option A (Factory Selection)

- Motor runs at 50% for 30 seconds.
- Motor then runs at 82% for approximately 7-1/2 minutes.
- If demand has not been satisfied after 7-1/2 minutes, motor runs at 100% until demand is satisfied.
- Once demand is met, motor runs at 50% for 30 seconds then ramps down to stop.

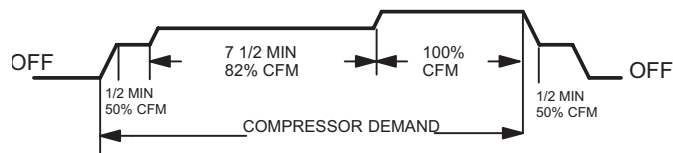

Ramping Option B

- Motor runs at 82% for approximately 7-1/2 minutes. If demand has not been satisfied after 7-1/2 minutes, motor runs at 100% until demand is satisfied.
- Once demand is met, motor ramps down to stop.



Ramping Option C

- Motor runs at 100% until demand is satisfied.
- Once demand is met, motor runs at 100% for 45 seconds then ramps down to stop.

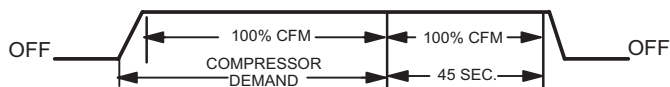

Ramping Option D

- Motor runs at 100% until demand is satisfied.
- Once demand is met, motor ramps down to stop.

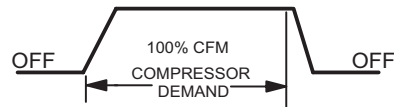

Switches 11, 12 and 13 -- Heating Mode Blower Speed

The switches are factory set to the OFF position which provides factory default heat speed. Refer to TABLE 8 for switches 11, 12 and 13 that provided the corresponding increases or decrease to both high and low heat demand.

TABLE 8

Heating Mode Blower Speeds

Heat Speed	Switch 11	Switch 12	Switch 13
Increase 24%	On	On	On
Increase 18%	On	On	Off
Increase 12%	On	Off	On
Increase 6%	On	Off	Off
Factory Default	Off	Off	Off
Decrease 6%	Off	Off	On
Decrease 12%	Off	On	Off
Decrease 18%	Off	On	On

Switches 14 and 15 -- Continuous Blower Speed --

TABLE 9 provides continuous blower speed adjustments that will result from different switch settings.

TABLE 9

Continuous Blower Speed

Continuous Blower Speed	Switch 14	Switch 15
28% of High Cool Speed	Off	On
38% of High Cool Speed (Factory Setting)	Off	Off

Switch 16 - Not Used

On Board Links

Note: In communicating systems with a conventional outdoor unit (non-communicating), the on-board clippable links must be set to properly configure the system.

On-Board Link W914 Dehum or Harmony (R to DS)

On-Board Link W914 Dehum or Harmony (R to DS) On-board link W914, is a clippable connection between terminals R and DS on the integrated control. W914 must be cut when the furnace is installed with either the ZSV variable zoning system control or a thermostat which features humidity control. If the link is left intact the PMW signal from the ZSV control will be blocked and also lead to control damage

Refer to TABLE 10 for operation sequence in applications including EL297UHV, a thermostat which features humidity control and a single-speed outdoor unit. TABLE 11 gives the operation sequence in applications with a two-speed outdoor unit.

On-Board Link W951 Heat Pump (R to O)

On-board link W951 is a clippable connection between terminals R and O on the integrated control. W951 must be cut when the furnace is installed in applications which include a heat pump unit and a thermostat which features dual fuel use. If the link is left intact, terminal "O" will remain energized eliminating the HEAT MODE in the heat pump.

On-Board Link W915 2 Stage Compr (Y1 to Y2)

On-board link W915 is a clippable connection between terminals Y1 and Y2 on the integrated control. W915 must be cut if two-stage cooling will be used. If the Y1 to Y2 link is not cut the outdoor unit will operate in second-stage cooling only.

**TABLE 10
OPERATING SEQUENCE**

Non-Communicating Thermostat with Humidity Control Feature and Single-Speed Outdoor Unit

OPERATING SEQUENCE		SYSTEM DEMAND				SYSTEM RESPONSE				
System Condition	Step	Thermostat Demand				Relative Humidity		Compressor	Blower CFM (cool)	Comments
		Y1	O	G	W1	Status	D			
<i>NO CALL FOR DEHUMIDIFICATION</i>										
Normal Operation	1	On	On	On		Acceptable	24 VAC	High	100%	Compressor and indoor blower follow thermostat demand
<i>BASIC MODE (only active on a Y1 thermostat demand)</i>										
Normal Operation	1	On	On	On		Acceptable	24 VAC	High	100%	CS7500 thermostat energizes Y1 and de-energizes D on a call for de-humidification
Dehumidification call	2	On	On	On		Demand	0 VAC	High	70%	
<i>PRECISION MODE (operates independent of a Y1 demand)</i>										
Normal Operation	1	On	On	On		Acceptable	24 VAC	High	100%	Dehumidification mode begins when humidity is greater than set point
Dehumidification Call	2	On	On	On		Demand	0 VAC	High	70%	
Dehumidification Call Only	1	On	On	On		Demand	0 VAC	High	70%	CS7500 thermostat will try to maintain room humidity setpoint by allowing the room space to maintain a cooler room thermostat setpoint**
		Jumpers at indoor unit with a single stage outdoor unit. With Condensing unit - Cut W914 (R to DS) on SureLight® control With Heat Pump - Cut W914 (R to DS) & W951 (R to O) on SureLight® control								
CS7000 thermostat to use for this application - Y2081 4 heat / 2 cool										
*Dehumidification blower speed is 70% of COOL speed for all units .										
**In Precision mode, CS7000 thermostat will maintain room temperature up to 2 °F (1.2°C) cooler than room setting.										

**TABLE 11
OPERATING SEQUENCE**

Non-Communicating Thermostat with Humidity Control Feature and Two-Speed Outdoor Unit

OPERATING SEQUENCE		SYSTEM DEMAND						SYSTEM RESPONSE				
System Condition	Step	Thermostat Demand						Relative Humidity		Compressor	Blower CFM (cool)	Comments
		Y1	Y2	O	G	W1	W2	Status	D			
NO CALL FOR DEHUMIDIFICATION												
Normal Operation Y1	1	On		On	On			Acceptable	24 VAC	Low	70%	Compressor and indoor blower follow thermostat demand
Normal Operation Y2	2	On	On	On	On			Acceptable	24 VAC	High	100%	
ROOM THERMOSTAT CALLS FOR FIRST STAGE COOLING												
BASIC MODE (only active on a Y1 thermostat demand)												
Normal Operation	1	On		On	On			Acceptable	24 VAC	Low	70%	CS7500 thermostat energizes Y1 and de-energizes D on a call for de-humidification
Dehumidification call	2	On	On	On	On			Demand	0 VAC	High	70%	
PRECISION MODE (operates independent of a Y1 demand)												
Normal Operation	1	On		On	On			Acceptable	24 VAC	Low	70%	Dehumidification mode begins when humidity is greater than set point
Dehumidification Call	2	On	On	On	On			Demand	0 VAC	High	70%	
Dehumidification Call Only	1	On	On	On	On			Demand	0 VAC	High	70%	CS 7500 thermostat will try to maintain room humidity setpoint by allowing the room space to maintain a cooler room thermostat setpoint**
ROOM THERMOSTAT CALLS FOR FIRST AND SECOND STAGE COOLING												
BASIC MODE (only active on a Y1 thermostat demand)												
Normal Operation	1	On	On	On	On			Acceptable	24 VAC	High	100%	CS7500 thermostat energizes Y2 and de-energizes D on a call for de-humidification
Dehumidification Call	2	On	On	On	On			Demand	0 VAC	High	70%	
PRECISION MODE (operates independent of a Y1 thermostat demand)												
Normal Operation	1	On		On	On			Acceptable	24 VAC	Low	70%	Dehumidification mode begins when humidity is greater than set point
Dehumidification Call	2	On	On	On	On			Demand	0 VAC	High	70%	
Dehumidification Call ONLY	1	On	On	On	On			Demand	0 VAC	High	70%	CS7500 thermostat will try to maintain room humidity setpoint by allowing the room space to maintain a cooler room thermostat setpoint***
	Jumpers at indoor unit with a two stage outdoor unit Cut factory jumper from Y1 to Y2 or cut W915 (Y1 to Y2) With Condensing unit - Cut W914 (R to DS) on SureLight® control With Heat Pump - Cut W914 (R to DS) & W951 (R to O) on SureLight® control											
<i>Dave Lennox CS7000 thermostat to use for this application - Y2081 4 heat / 2 cool</i>												
<i>*Normal operation first stage cooling blower speed is 70% COOL speed.</i>												
<i>**Dehumidification blower speed is, reduced to 70% of COOL.</i>												
<i>***In Precision mode, CS 7000 thermostat will maintain room temperature up to 2 °F (1.2°C) cooler than room setting.</i>												

B- Indoor Blower Motor

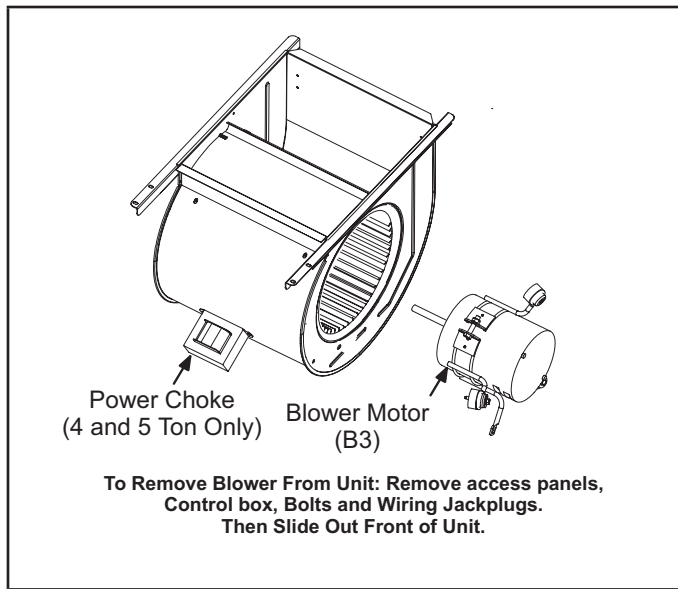

FIGURE 7

Blower Drive

Some EL297UHV units will be equipped with a blower drive shown in FIGURE 8 with LED codes for operation in TABLE 12. The blower drive is not repairable. If it fails replace the drive.

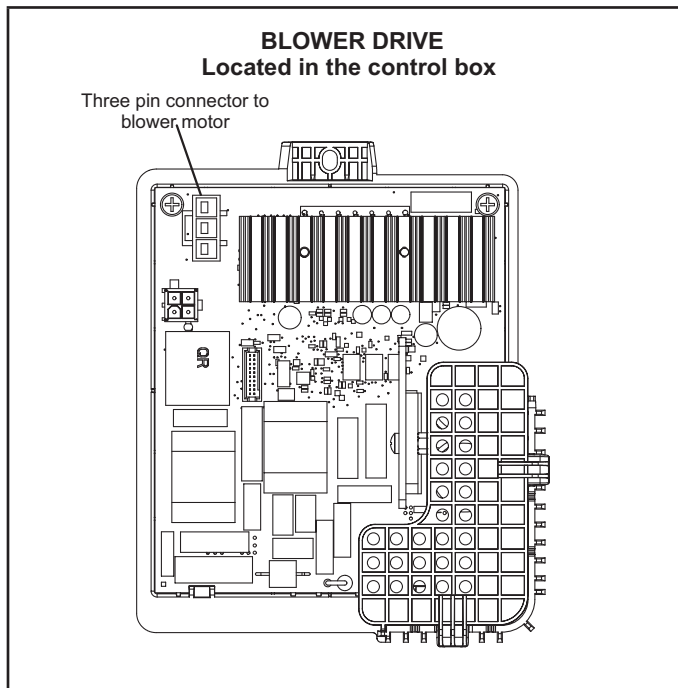

FIGURE 8

! IMPORTANT

Earlier ECM motors used on other Lennox furnace models are not interchangeable with motors used on the EL297UH furnace line.

TABLE 12

Led*	Meaning
1 short blink	Normal heartbeat
2 short blinks	Drive fault replace drive
3 short blinks	
4 short blinks	
5 short blinks	Temporary fault (see troubleshooting page 52)
1 long blink + 1 short blink	
1 long blink + 2 short blinks	
1 long blink + 3 short blinks	

* Do not touch or remove drive for replacement until all blinking lights are off. Blinking light(s) indicates drive still has power.

! WARNING

During blower operation, the ECM motor emits energy that may interfere with pacemaker operation. Interference is reduced by both the sheet metal cabinet and distance.

The motor communicates with the integrated control via a 2-way serial connection. The motor receives all necessary functional parameters from the integrated control and does not rely on a factory program like traditional variable speed motors. EL297UHV units use a three-phase, electronically controlled D.C. brushless motor (controller converts single phase a.c. to three phase D.C.), with a permanent-magnet type rotor (FIGURE 9). Because this motor has a permanent magnet rotor it does not need brushes like conventional D.C. motors.

The stator windings are split into three poles which are electrically connected to the controller. This arrangement allows motor windings to turn on and off in sequence by the controller.

A solid-state controller is permanently attached to the motor. The controller is primarily an A.C. to D.C. converter. Converted D.C. power is used to drive the motor. The controller contains a microprocessor which monitors varying conditions inside the motor (such as motor workload).

BLOWER MOTOR COMPONENTS

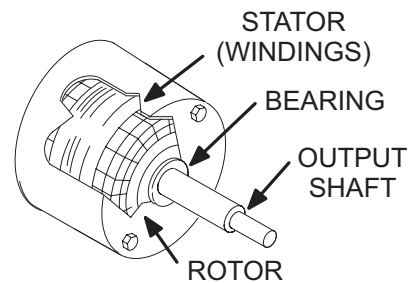

FIGURE 9

The controller uses sensing devices to sense what position the rotor is in at any given time. By sensing the position of the rotor and then switching the motor windings on and off in sequence, the rotor shaft turns the blower.

All EL297UHV blower motors use single phase power. An external run capacitor is not used. The motor uses permanently lubricated ball-type bearings.

Internal Operation

The motor is controlled via serial communication between the integrated control on the furnace and the controller attached to the motor shell. The messages sent back and forth between the two controls serve to communicate rotational direction, demand, motor size, current draw, torque, and rpm, among other variables.

Motor rpm is continually adjusted internally to maintain constant static pressure against the blower wheel. The controller monitors the static work load on the motor and motor ampdraw to determine the amount of rpm adjustment. Blower rpm may be adjusted any amount in order to maintain a constant cfm as shown in Blower Ratings Tables. The cfm remains relatively stable over a broad range of static pressure. Since the blower constantly adjusts rpm to maintain a specified cfm, motor rpm is not rated. Hence, the terms “cool speed”, “heat speed ” or “speed tap” in this manual, on the unit wiring diagram and on blower B3, refer to blower cfm regardless of motor rpm.

Initial Power Up

When line voltage is applied to B3, there will be a large inrush of power lasting less than 1/4 second. This inrush charges a bank of DC filter capacitors inside the controller. If the disconnect switch is bounced when the disconnect is closed, the disconnect contacts may become welded. Try not to bounce the disconnect switch when applying power to the unit.

Motor Start-Up

When B3 begins start-up, the motor gently vibrates back and forth for a moment. This is normal. During this time the electronic controller is determining the exact position of the rotor.

Once the motor begins turning, the controller slowly eases the motor up to speed (this is called “soft-start”). The motor may take as long as 10-15 seconds to reach full speed. If the motor does not reach 200 rpm within 13 seconds, the motor shuts down. Then the motor will immediately attempt a restart. The shutdown feature provides protection in case of a frozen bearing or blocked blower wheel. The motor may attempt to start eight times. If the motor does not start after the eighth try, the controller locks out. Reset controller by momentarily turning off power to unit.

The DC filter capacitors inside the controller are connected electrically to the motor supply wires. The capacitors take approximately 5 minutes to discharge when the disconnect is opened. For this reason it is necessary to wait at least 5 minutes after turning off power to the unit before attempting to service motor.



Power Choke (L13)

A choke coil is used on EL297UHV 4 and 5 ton units equipped with 1 hp motors. The choke is located on the blower housing and is used to suppress transient current spikes.

Troubleshooting Motor Operation

To verify motor operation see steps below and FIGURE 10 and FIGURE 11.

- 1 - Remove J48 (5 pin power plug) from P48 on the motor.
- 2 - With the power on at the furnace and door switch depressed, use a test meter to verify 120V between pins 4 and 5 on J48.
- 3 - Reconnect J48 to P48 on the motor.
- 4 - Remove J49 (4 pin low voltage connector) from P49 on the motor.
- 5 - Using test jumpers, apply 24V to pins 3 and 4 on P49 on the motor.

Note: Do not apply 24V to pins 2 and 4 on P49. Doing so will cause permanent damage to the motor.

- 6 - Motor should run at 75%.
- 7 - Test is complete. Remove jumpers and reconnect plugs.

Another option is to use the TECMate PRO motor tester with the 16 to 4 pin adaptor. The use of the TECMate PRO isolates the motor from the integrated control. Follow the instructions provided with the kit. If the motor runs do not replace.

BLOWER B3 HARNESS CONNECTORS

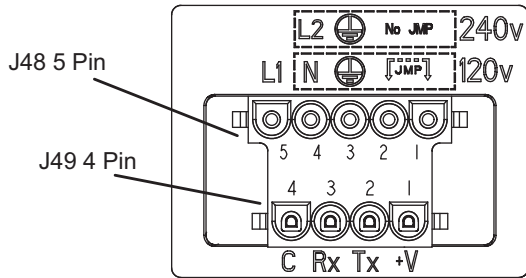
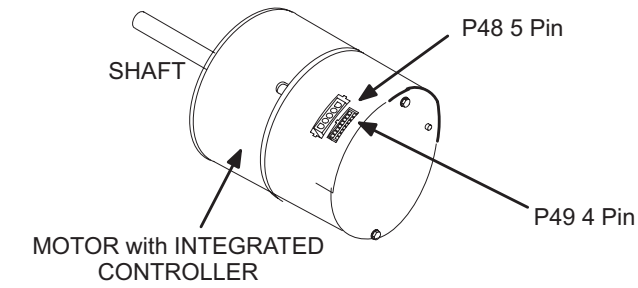

J49 4 Pin Control Connector	
PIN	DESCRIPTION
1	12V INPUT
2	SERIAL DATA OUTPUT
3	SERIAL DATA INPUT
4	COMMON

J48 5 Pin Line Voltage Connector	
PIN	DESCRIPTION
1	JUMPER PIN 1 TO PIN 2 FOR 120VAC LINE INPUT ONLY ***
2	120VAC LINE INPUT ONLY ***
3	CHASSIS GROUND
4	AC LINE
5	AC LINE

FIGURE 10

BLOWER B3 HARNESS CONNECTORS

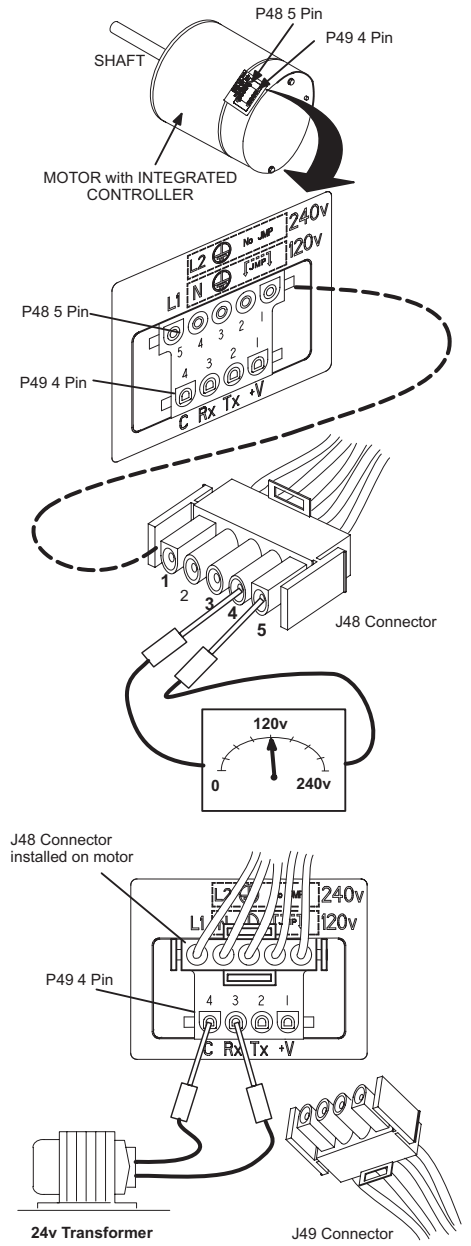

FIGURE 11

Troubleshooting Motor Windings

Ensure that motor windings are not damaged by performing the following tests:

NOTE - If your ohm meter is not an auto-ranging type, set it to the highest ohm scale (100k ohms or greater) before performing tests.

TABLE 13
Ohm Meter Range

Scale	Measurement Range	
	in words	ohms
2M	two megohm -- two million ohms	0-2,000,000
200K	two hundred kilohm -- two hundred thousand ohms	0-200,000
20K	twenty kilohm -- twenty thousand ohms	0-20,000
2K	two kilohm -- two thousand ohms	0-2,000
200	two hundred ohm	0-200

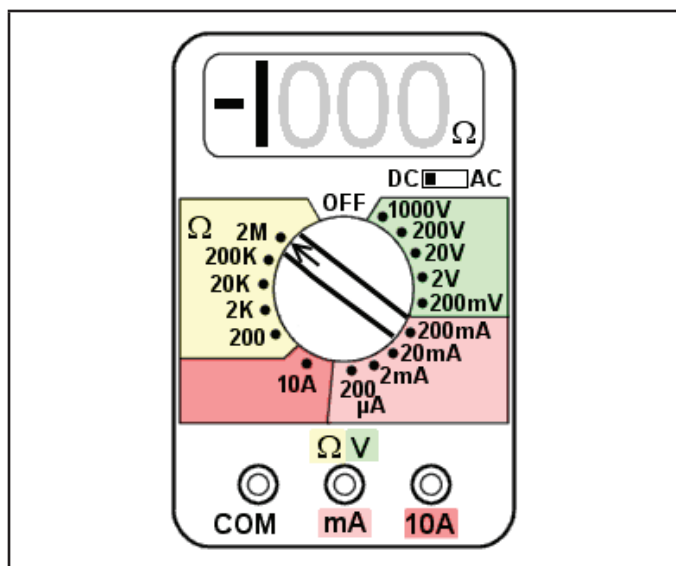

FIGURE 12
TEST A

Measure the resistance between each of the three motor leads (3-pin plug) and the unpainted part of the end shield. If the winding resistance to ground is <100k ohms, replace the motor and control module. If the resistance to ground is >100k, the motor windings are fine. Proceed to Test B.

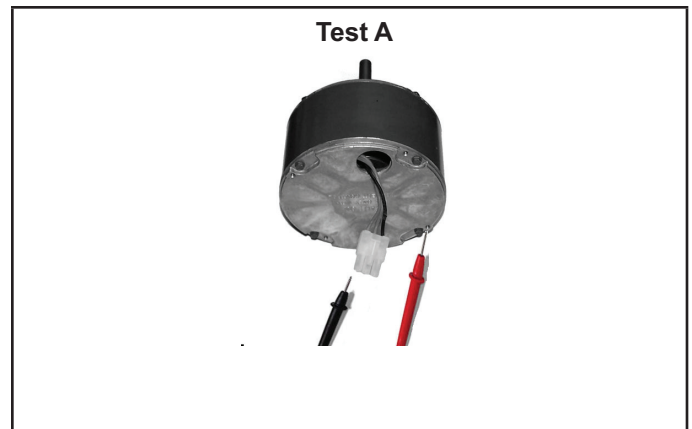

FIGURE 13
TEST B

Use an ohmmeter to measure the motor phase-to-phase resistance by checking these combinations of the the 3-pin motor plug. For the purpose of this test, start at either end of the connector as lead 1.

- 1 - The lead-to-lead resistance across any two leads should be less than 20 ohms.
- 2 - Each lead-to-lead resistance should be the same. If the measured resistance is greater than 20 ohms, replace the motor and control module.

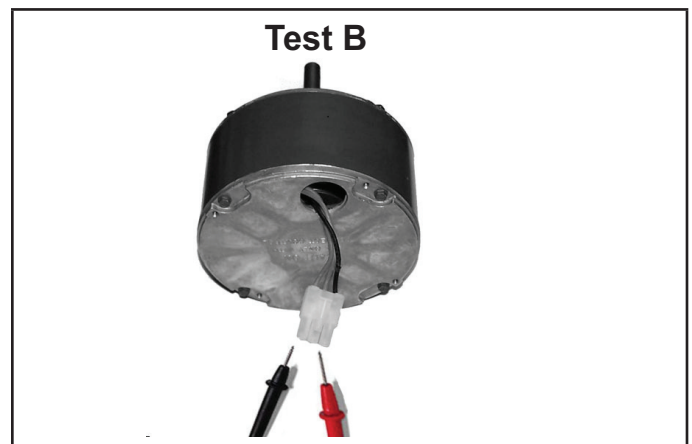

FIGURE 14

Models with the Lennox Blower Drive

Removed the three blower leads from the blower drive. see TEST A. If ohms to ground shows resistance replace motor. If the circuit is open move to test B and table below for acceptable resistance. If ohm reading is met motor has passed. If the motor passes both test A and B and the shaft spins freely by hand, replace the blower drive.

Motor HP	Ohm Reading
1/2	7.6 ± .76
3/4	6.3 ± .63
1	4.7 ± .47

C- Heating Components

1. Ignitor

The SureLight® ignitor is made of durable silicon nitride. Longevity is enhanced by controlling voltage to the ignitor. The integrated control provides a regulated 120 volts to the ignitor for a consistent ignition and long ignitor life.

Ohm value should be 39 to 70. See FIGURE 15 for ignitor location and FIGURE 16 for ignitor check out.

NOTE - The EL297UHV(X) furnace contains electronic components that are polarity sensitive. Make sure that the furnace is wired correctly and is properly grounded.

2. Flame Sensor

A flame sensor is located on the left side of the burner support. See FIGURE 15. The sensor tip protrudes into the flame envelope of the left-most burner. The sensor can be removed for service without removing any part of the burners. During operation, flame is sensed by current passed through the flame and sensing electrode. The SureLight control allows the gas valve to remain open as long as flame signal is sensed. To check flame sense signal use the push-button found on the integrated control and go to Field Test Mode. The menu will display the flame signal. See TABLE 14 for flame signal.

TABLE 14
Flame Signal in Microamps

Normal	Low	Drop Out
2.6 or greater	2.5 or less	1.1

3. Gas Valve

The valve (FIGURE 52) is internally redundant to assure safety shut-off. If the gas valve must be replaced, the same type valve must be used.

24VAC terminals and gas control knob are located on the valve. A wire harness connects the terminals from the gas valve to the electronic ignition control. 24V applied to the terminals energizes the valve. Inlet and outlet pressure taps are located on the valve. A regulator adjustment screw is located on the valve.

LPG change over kits are available from Lennox. Kits include burner orifices and a gas valve.

4. Flame Rollout Switches (S47)

Flame rollout switch is a high temperature limit located on top of the burner box, one on each side.- See FIGURE 15. The limit is a N.C. SPST manual-reset limit. When S47 senses rollout, the circuit breaks and the ignition control immediately stops ignition and closes the gas valve. Rollout can be caused by a blocked heat exchanger, flue or lack of combustion air. The switch is factory set to trip (open) at 210°F and cannot be adjusted. The switch can be manually reset. To manually reset a tripped switch, push the reset button located on the control.

5. Burners

All units use inshot burners. Burners are factory set and require no adjustment. Always operate the unit with the burner box front panel in place. Each burner uses an orifice that is precisely matched to the burner input. Burners can be removed as a one piece assembly for service. If burner assembly has been removed, it is critical to align center of each burner to the center of the clamshell when re-installing. See more detail in Section VI- MAINTENANCE.

6. Primary Limit Control (S10)

The primary limit (S10) is located in the heating vestibule panel. When excess heat is sensed in the heat exchanger, the limit will open. If the limit is open, the furnace control energizes the supply air blower and closes the gas valve. The limit automatically resets when unit temperature returns to normal. The switch must reset within three minutes or the SureLight control will go into Watch guard for one hour. The switch is factory set and cannot be adjusted. The switch may have a different set point for each unit model number. See Lennox Repair Parts Handbook if limit switch must be replaced.

HEATING COMPONENTS

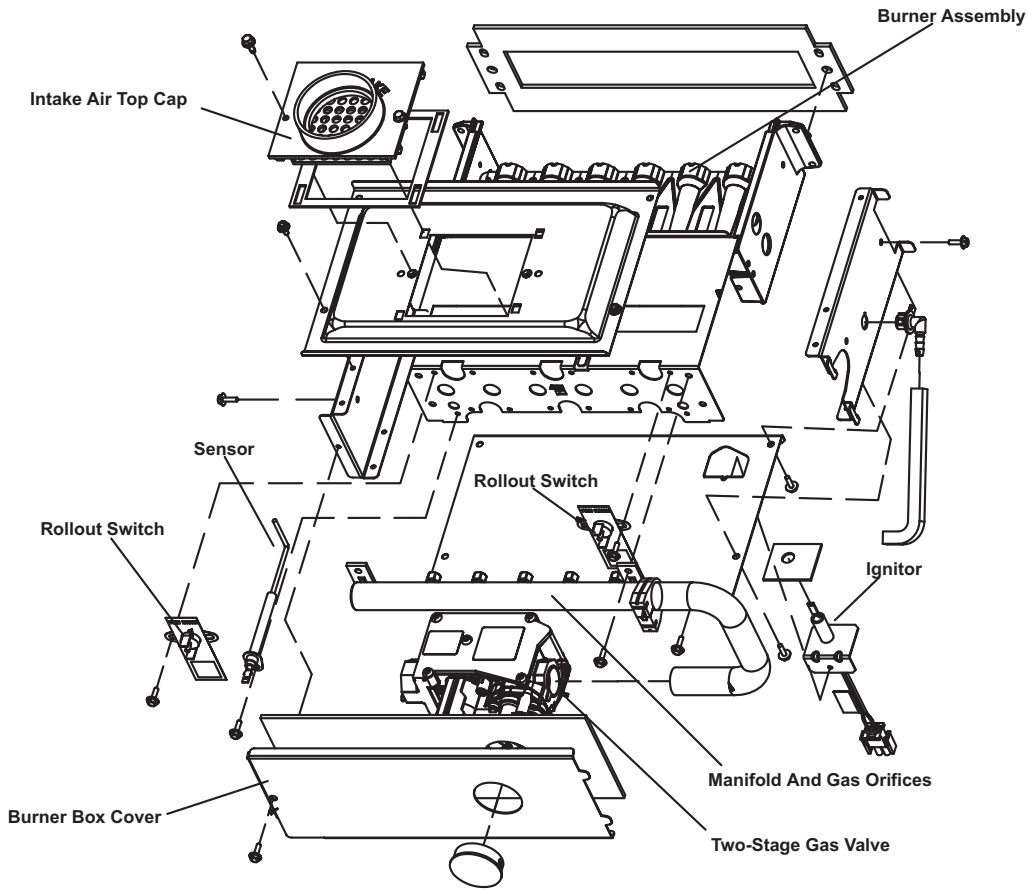

FIGURE 15

Ignitor Check

Test 1

Check ignitor circuit for correct resistance.
Remove 4-pin plug from control.
Check ohms reading across terminals 1 and 5.
Reading should be between 39 and 70 ohms. If value is correct, this is the only test needed. If the reading on the meter is not correct, (0 or infinity) then a second test is needed.

Meter
(set to ohms)

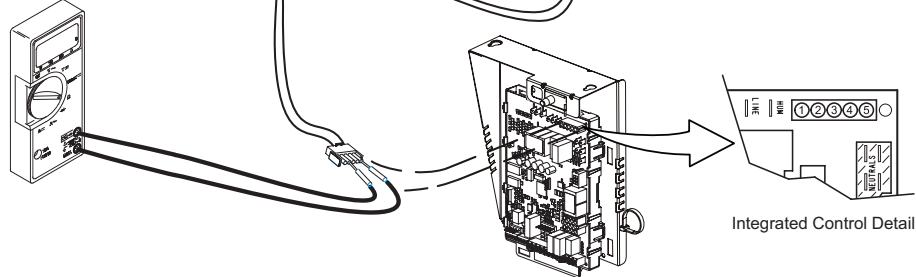

Test 2

Check ignitor for correct resistance.
Separate the 2-pin jack-plug near the manifold and check resistance of ignitor at the plug. Reading should be between 39 and 70 ohms. If the reading is correct, then the problem is with the wiring between the jack-plug and the control. If reading is not correct, the issue is the ignitor.

Meter
(set to ohms)

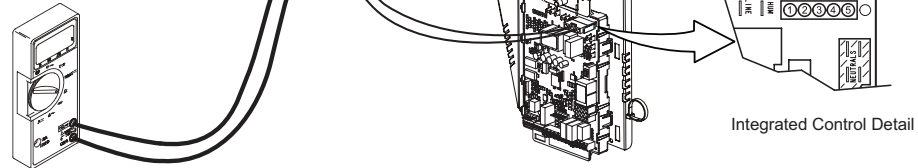

Test 3

Check ignitor for correct voltage
Insert meter probes into terminals 1 and 5 (use small diameter probes in order not to damage plug).
Check voltage during 20 second ignitor warm up period.
Voltage should read 120 volts \pm 10%. If voltage reads below these values, check for correct supply voltage to furnace.

Meter
(set to AC volts)

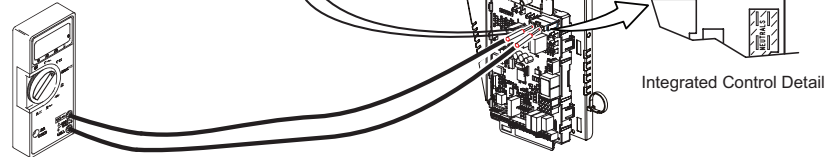

FIGURE 16

7. Combustion Air Inducer (B6) and

Cold End Header Box

All EL297UHV(X) units use a two-stage combustion air inducer to move air through the burners and heat exchanger during heating operation. The blower uses a 120VAC motor. The motor operates during all heating operation and is controlled by integrated control A92. The inducer also operates for 15 seconds before burner ignition (prepurge) and for 5 seconds after the gas valve closes (postpurge). The inducer operates on low speed during first stage heat, then switches to high speed for second stage heat.

NOTE - Each furnace model uses a unique CAI. Refer to Lennox Repair Parts listing for correct inducer for replacement.

The combustion air inducer is installed on the cold end header box. The cold end header box is a single piece made of hard plastic. The box has an internal channel where the combustion air inducer creates negative pressure at unit start up. The channel contains an orifice used to regulate flow created by the combustion air inducer.

The box has pressure taps for the combustion air inducer pressure switch hoses. The pressure switch measures the pressure differential across the combustion air inducer orifice or difference in the channel and the box. **If replacement is necessary the gaskets used to seal the box to the vestibule panel and the combustion air inducer to the box, must also be replaced.**

A proving switch connected to the combustion air inducer orifice plate is used to prove inducer operation. The combustion air inducer orifice will be different for each model. See TABLE 15 for orifice sizes. The pressure switch measures the pressure differential across the combustion air inducer orifice. When the proving switch opens, the furnace control (A92) immediately closes the gas valve to prevent burner operation.

TABLE 15

EL297UHV Unit	C.A.I. Orifice Size
-045	0.650
-070	0.810
-090	0.920
-110	1.070
-135	1.300

8. Combustion Air Inducer Pressure Switch (S18)

EL297UHV(X) series units are equipped with a dual combustion air pressure switch (first and second stage) located on the combustion air inducer orifice bracket. See FIGURE 17. The switch is connected to the combustion air inducer housing by means of a flexible silicone hose. It monitors negative air pressure in the combustion air inducer housing.

The switches are a single-pole single-throw pressure switch electrically connected to the integrated control. The purpose of the switch is to prevent burner operation if the combustion air inducer is not operating or if the flue becomes obstructed.

On heat demand (first or second stage) the switch senses that the combustion air inducer is operating. It closes a circuit to the integrated control when pressure inside the combustion air inducer decreases to a certain set point. Set points vary depending on unit size. See TABLE 16 0 - 4500' The pressure sensed by the switch is negative relative to atmospheric pressure. If the flue becomes obstructed during operation, the switch senses a loss of negative pressure becomes more equal with atmospheric pressure) and opens the circuit to the furnace control and gas valve. A bleed port on the switch allows relatively dry air in the vestibule to purge switch tubing, to prevent condensate build up.

NOTE - The switch is factory set and is not field adjustable. It is a safety shut-down control in the furnace and must not be by-passed for any reason. If switch is closed or bypassed, the control will not initiate ignition at start up.

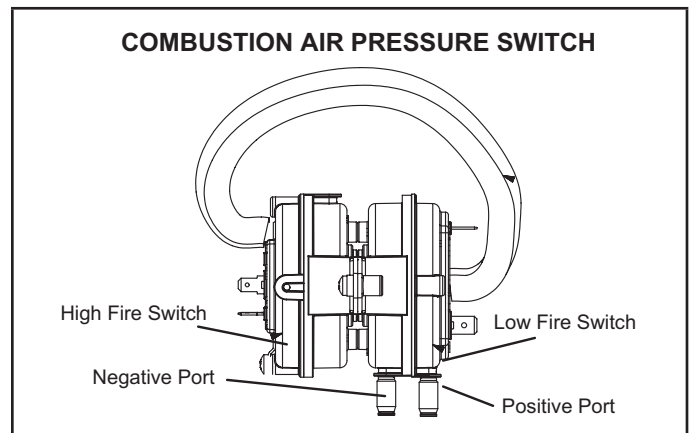

FIGURE 17

TABLE 16 0 - 4500'

Unit	Set Point High Heat	Set Point Low Heat
-045	0.80	0.50
-070	0.95	0.55
-090	0.90	0.50
-110	1.00	0.55
-135	0.85	0.45

TABLE 17 4501 - 7500'

Unit	Set Point High Heat	Set Point Low Heat
-045	0.74	0.41
-070	0.85	0.50
-090	0.75	0.45
-110	0.95	0.55
-135	0.80	0.40

TABLE 18 7500 - 10,000'

Unit	Set Point High Heat	Set Point Low Heat
-045	0.70	0.40
-070	0.75	0.45
-090	0.70	0.40
-110	0.90	0.50
-135	0.75	0.35

Pressure Switch Check

To check pressure switch differential, refer to FIGURE 18 and use the provided fittings and tubing to follow the steps below.

- 1 - Remove thermostat demand and allow unit to cycle off.
- 2 - Remove the tubing from the negative side (red and black or red) and positive side (black) of the pressure switch (leave both connected to cold end header box).
- 3 - Take the 2" length square tubing and connect to the positive (+) side of the pressure switch. Take the 10" length square tubing and tee into the tubing from the positive side of the cold end header box and the other side of the 2" square tubing. Connect the other end of the 10" square tubing the positive (+) side of the measuring device.
- 4 - Take a second piece the 2" length square tubing and connect to the negative (-) side of the pressure switch. Take a second piece of 10" length square tubing and tee into the tubing from the negative (-) side of the cold end header box and the other side of the 2" square tubing. Connect the other end of the 10" square tubing to the negative (-) side of the measuring device.
- 5 - Operate unit and observe manometer reading. Readings will change as heat exchanger warms.
 - a. Take one reading immediately after start-up.
 - b. Take a second reading after unit has reached steady state (approximately 5 minutes). This will be the pressure differential.
- 6 - Remove thermostat demand and allow to cycle off.
- 7 - Replace original pressure switch tubing.

The pressure differential should be at least 0.15" greater than those listed in the TABLE 16 0 - 4500' TABLE 17 4501 - 7500' and TABLE 18 7500 - 10,000' Readings in table are the set points or "break points".

NOTE - Pressure differential values (set point) in table are the "break", or "open" specifications. "Make", or "close" pressure differentials are 0.15" greater than the set points listed in table.

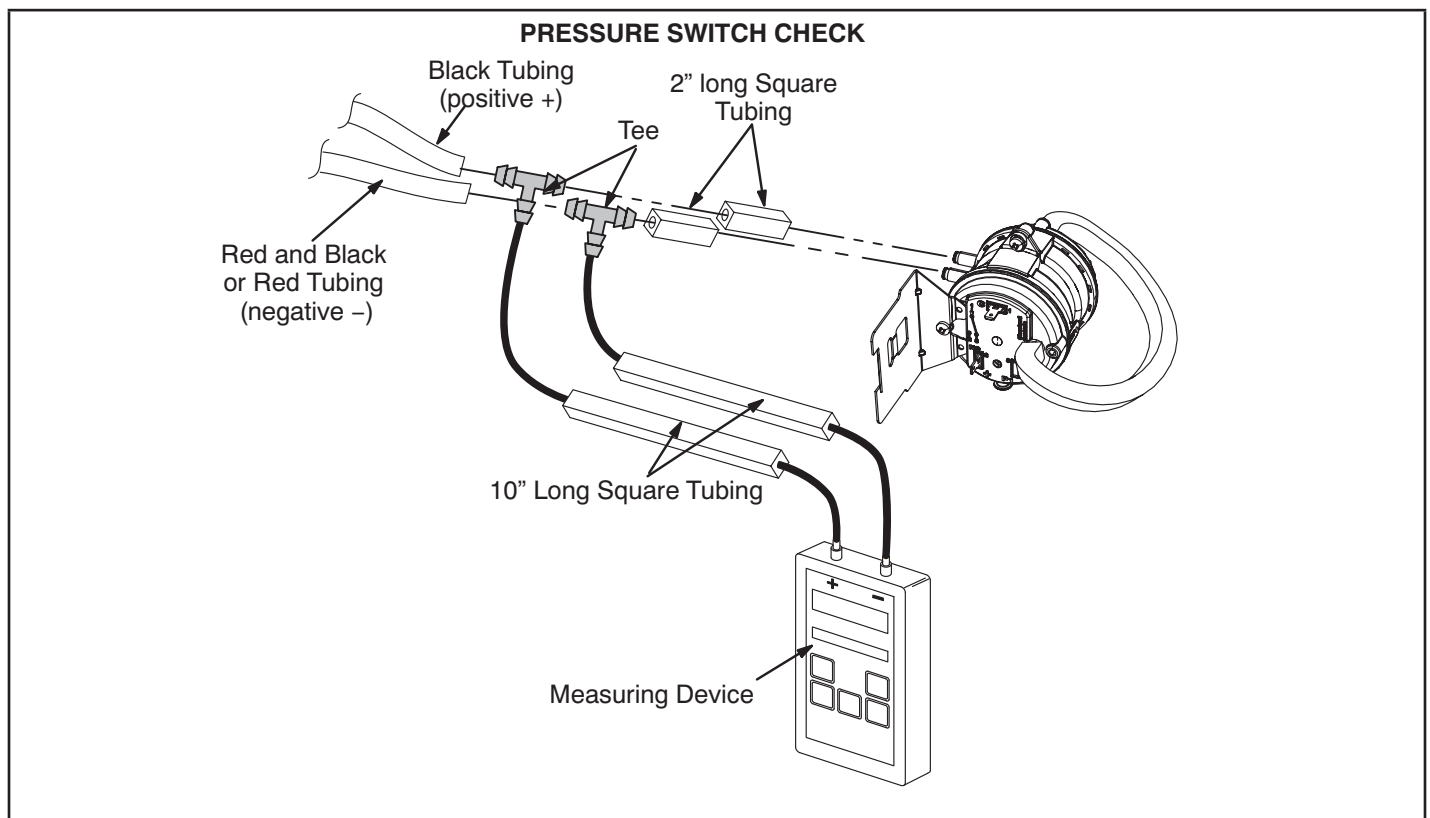

FIGURE 18

II-PLACEMENT AND INSTALLATION

All pipe, fittings, primer and solvent cement must conform with American National Standard Institute and the American Society for Testing and Materials (ANSI/ASTM) standards. The solvent shall be free flowing and contain no lumps, undissolved particles or any foreign matter that adversely affects the joint strength or chemical resistance of the cement. The cement shall show no gelation, stratification, or separation that cannot be removed by stirring. Refer to TABLE 19 below for approved piping and fittings.

**TABLE 19
PIPING AND FITTINGS SPECIFICATIONS**

Schedule 40 PVC (Pipe)	D1785
Schedule 40 PVC (Cellular Core Pipe)*	F891
Schedule 40 PVC (Fittings)	D2466
Schedule 40 CPVC (Pipe)	F441
Schedule 40 CPVC (Fittings)	F438
SDR-21 PVC or SDR-26 PVC (Pipe)	D2241
SDR-21 CPVC or SDR-26 CPVC (Pipe)	F442
Schedule 40 ABS Cellular Core DWV (Pipe)*	F628
Schedule 40 ABS (Pipe)	D1527
Schedule 40 ABS (Fittings)	D2468
ABS-DWV (Drain Waste & Vent) (Pipe & Fittings)	D2661
PVC-DWV (Drain Waste & Vent) Pipe & Fittings)	D2665
PRIMER & SOLVENT CEMENT	ASTM SPECIFICATION
PVC & CPVC Primer	F656
PVC Solvent Cement	D2564
CPVC Solvent Cement	F493
ABS Solvent Cement	D2235
PVC/CPVC/ABS All Purpose Cement For Fittings & Pipe of the same material	D2564, D2235, F493
ABS to PVC or CPVC Transition Solvent Cement	D3138
CANADA PIPE & FITTING & SOLVENT CEMENT	MARKING
PVC & CPVC Pipe and Fittings	ULCS636
PVC & CPVC Solvent Cement	
ABS to PVC or CPVC Transition Cement	
POLYPROPYLENE VENTING SYSTEM	
PolyPro® by Duravent	UL1738
InnoFlue® by Centrotherm	
UL 1738 CERTIFIED GAS VENTING SYSTEM	
IPEX System1738 Schedule 40 PVC Pipes and Fittings	UL1738
IPEX System1738 PVC FGV Cement & Primer	

* Not approved as of 12-1-2022

CAUTION

Solvent cements for plastic pipe are flammable liquids and should be kept away from all sources of ignition. Do not use excessive amounts of solvent cement when making joints. Good ventilation should be maintained to reduce fire hazard and to minimize breathing of solvent vapors. Avoid contact of cement with skin and eyes.

IMPORTANT

EL297UHV exhaust and intake connections are made of PVC. Use PVC primer and solvent cement when using PVC vent pipe. When using ABS vent pipe, use transitional solvent cement to make connections to the PVC fittings in the unit.

Use PVC primer and solvent cement or ABS solvent cement meeting ASTM specifications, refer to TABLE 19. As an alternate, use all purpose cement, to bond ABS, PVC, or CPVC pipe when using fittings and pipe made of the same materials. Use transition solvent cement when bonding ABS to either PVC or CPVC.

Low temperature solvent cement is recommended during cooler weather. Metal or plastic strapping may be used for vent pipe hangers. Uniformly apply a liberal coat of PVC primer for PVC or use a clean dry cloth for ABS to clean inside socket surface of fitting and male end of pipe to depth of fitting socket.

Canadian Applications Only - Pipe, fittings, primer and solvent cement used to vent (exhaust) this appliance must be certified to ULC S636 and supplied by a single manufacturer as part of an approved vent (exhaust) system. In addition, the first three feet of vent pipe from the furnace flue collar must be accessible for inspection.

**TABLE 20
OUTDOOR TERMINATION USAGE***

Input Size	Vent Pipe Dia. in.	STANDARD			CONCENTRIC			
		Flush Mount Kit	Wall Kit		Field Fabricated	1-1.2 inch	2 inch	3 inch
			2 inch	3 inch		71M80 (US) 444W92 (CA)	69M29 (US) 444W92 (CA)	60L46 (US) 444W93 (CA)
		51W11 (US) 51W12 (CA)	22G44 (US) 430G28 (CA)	44J40 (US) 481J20 (CA)				
045	⁶ 1-1/2	³ YES	YES	¹ YES	⁵ YES	² YES		
	2	³ YES	YES	¹ YES	⁵ YES	² YES		
	2-1/2	³ YES	YES	¹ YES	⁵ YES	² YES		
	3	³ YES	YES	¹ YES	⁵ YES	² YES		
070	⁶ 1-1/2	³ YES	YES	¹ YES	⁵ YES	² YES		
	2	³ YES	YES	¹ YES	⁵ YES	² YES		
	2-1/2	³ YES	YES	¹ YES	⁵ YES	² YES		
	3	³ YES	YES	¹ YES	⁵ YES	² YES		
090	2	³ YES		YES	⁵ YES		YES YES	
	2-1/2	³ YES		YES	⁵ YES		YES YES	
	3	³ YES		YES	⁵ YES		YES YES	
110	2	YES		YES	⁵ YES		YES YES	
	2-1/2	YES		YES	⁵ YES		YES YES	
	3	YES		YES	⁵ YES		YES YES	
135	3	YES		YES	⁵ YES		YES	

NOTE - Standard Terminations do not include any vent pipe or elbows external to the structure. Any vent pipe or elbows external to the structure must be included in total vent length calculations. See vent length tables.

* Kits must be properly installed according to kit instructions.

1 Requires field-provided outdoor 1-1/2" exhaust accelerator.

2 Concentric kits 71M80 and 44W92 include 1-1/2" outdoor accelerator, when used with 045 and 070 input models. 1-1/2 in. pipe must be transitioned to 2 in. when used with a concentric kit.

3 Flush mount kits 51W11 and 51W12 includes 1-1/2 in. outdoor exhaust accelerator, required when used with 045, 070 and 090 input models. 1-1/2 in. pipe must be transitioned to 2 in. pipe when used with the flushmount kit.

4 Termination kits 30G28, 44W92, 44W93 and 81J20 are certified to ULC S636 for use in Canada only.

5 See table 8 for vent accelerator requirements.

6 2 in. pipe to 1-1/2 in. reducer required and must be field provided.

Joint Cementing Procedure

All cementing of joints should be done according to the specifications outlined in ASTM D 2855.

DANGER

DANGER OF EXPLOSION!

Fumes from PVC glue may ignite during system check. Allow fumes to dissipate for at least 5 minutes before placing unit into operation..

- 1 - Measure and cut vent pipe to desired length.
- 2 - Debur and chamfer end of pipe, removing any ridges or rough edges. If end is not chamfered, edge of pipe may remove cement from fitting socket and result in a leaking joint.

NOTE - Check the inside of vent pipe thoroughly for any obstruction that may alter furnace operation.

- 3 - Clean and dry surfaces to be joined.
- 4 - Test fit joint and mark depth of fitting on outside of pipe.

- 5 - Uniformly apply a liberal coat of PVC primer for PVC or use a clean dry cloth for ABS to clean inside socket surface of fitting and male end of pipe to depth of fitting socket.

NOTE - Time is critical at this stage. Do not allow primer to dry before applying cement.

- 6 - Promptly apply solvent cement to end of pipe and inside socket surface of fitting. Cement should be applied lightly but uniformly to inside of socket. Take care to keep excess cement out of socket. Apply second coat to end of pipe.

- 7 - Immediately after applying last coat of cement to pipe, and while both inside socket surface and end of pipe are wet with cement, forcefully insert end of pipe into socket until it bottoms out. Turn PVC pipe 1/4 turn during assembly (but not after pipe is fully inserted) to distribute cement evenly. DO NOT turn ABS or cellular core pipe.

NOTE - Assembly should be completed within 20 seconds after last application of cement. Hammer blows uld not be used when inserting pipe.

- 8 - After assembly, wipe excess cement from pipe at end of fitting socket. A properly made joint will show a bead around its entire perimeter. Any gaps may indicate an improper assembly due to insufficient solvent.
- 9 - Handle joints carefully until completely set.

Venting Practices

HORIZONTAL PIPING SUPPORT GUIDELINES

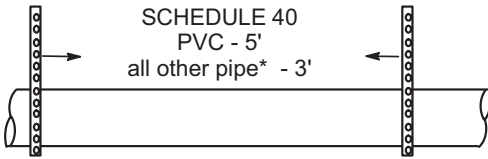

* See Piping and Fittings Specifications table

NOTE - Vertical support guidelines: Recommend following the guidelines in the International Plumbing code for PVC.

NOTE - Isolate piping at the point where it exits the outside wall or roof in order to prevent transmission of vibration to the structure.

Wall Thickness Guidelines

24" maximum
3/4" minimum

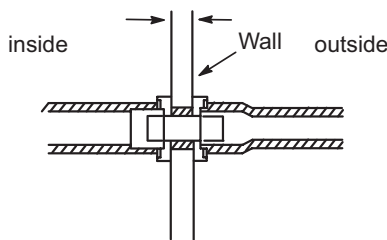

FIGURE 19

- 1 - In areas where piping penetrates joists or interior walls, hole must be large enough to allow clearance on all sides of pipe through center of hole using a hanger.
- 2 - When furnace is installed in a residence where unit is shut down for an extended period of time, such as a vacation home, make provisions for draining condensate collection trap and lines.

Removal of the Furnace from Common Vent

In the event that an existing furnace is removed from a venting system commonly run with separate gas appliances, the venting system is likely to be too large to properly vent the remaining attached appliances.

Conduct the following test while each appliance is operating and the other appliances (which are not operating) remain connected to the common venting system. If the venting system has been installed improperly, you must correct the system as indicated in the general venting requirements section.

⚠ WARNING

CARBON MONOXIDE POISONING HAZARD

Failure to follow the steps outlined below for each appliance connected to the venting system being placed into operation could result in carbon monoxide poisoning or death.

The following steps shall be followed for each appliance connected to the venting system being placed into operation, while all other appliances connected to the venting system are not in operation:

- 1 - Seal any unused openings in the common venting system.
- 2 - Inspect the venting system for proper size and horizontal pitch. Determine that there is no blockage, restriction, leakage, corrosion, or other deficiencies which could cause an unsafe condition.
- 3 - Close all building doors and windows and all doors between the space in which the appliances remaining connected to the common venting system are located and other spaces of the building. Turn on clothes dryers and any appliances not connected to the common venting system. Turn on any exhaust fans, such as range hoods and bathroom exhausts, so they will operate at maximum speed. Do not operate a summer exhaust fan. Close fireplace dampers.
- 4 - Follow the lighting instructions. Turn on the appliance that is being inspected. Adjust the thermostat so that the appliance operates continuously.
- 5 - After the main burner has operated for 5 minutes, test for leaks of flue gases at the draft hood relief opening. Use the flame of a match or candle.
- 6 - After determining that each appliance connected to the common venting system is venting properly, (step 3 return all doors, widows, exhaust fans, fireplace dampers, and any other gas-burning appliances to their previous mode of operation.
- 7 - If a venting problem is found during any of the preceding tests, the common venting system must be modified to correct the problem.

Resize the common venting system to the minimum vent pipe size determined by using the appropriate tables in Appendix G. (These are in the current standards).

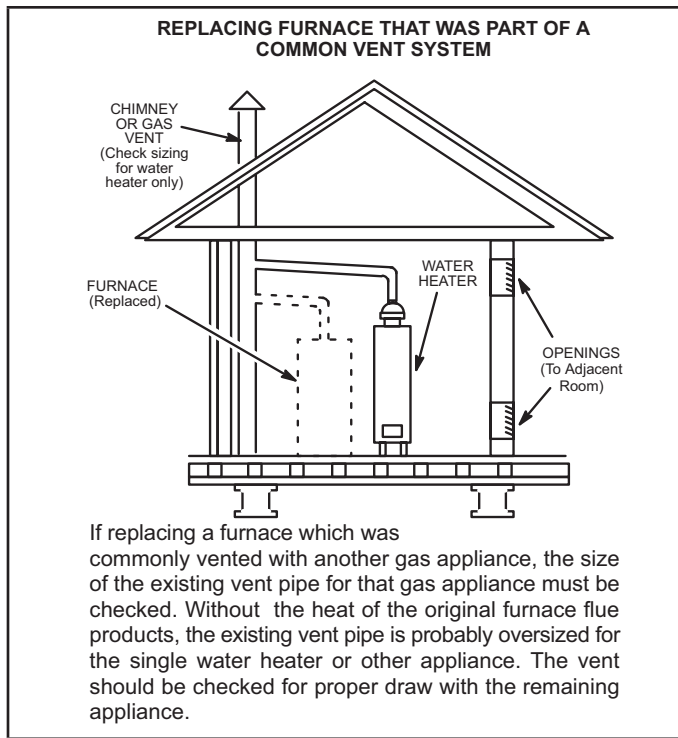

FIGURE 20

Exhaust Piping (FIGURE 21, FIGURE 23 and FIGURE 24)

Route piping to outside of structure. Continue with installation following instructions given in piping termination section.

⚠ CAUTION

Do not discharge exhaust into an existing stack or stack that also serves another gas appliance. If vertical discharge through an existing unused stack is required, insert PVC pipe inside the stack until the end is even with the top or outlet end of the metal stack.

⚠ CAUTION

The exhaust vent pipe operates under positive pressure and must be completely sealed to prevent leakage of combustion products into the living space.

Vent Piping Guidelines

NOTE - Lennox has approved the use of DuraVent® and Centrotherm manufactured vent pipe and terminations as an option to PVC. When using the PolyPro® by DuraVent or InnoFlue® by Centrotherm venting system the vent pipe requirements stated in the unit installation instruction – minimum & maximum vent lengths, termination clearances, etc. – apply and must be followed. Follow the instructions provided with PolyPro by DuraVent and InnoFlue by Centrotherm venting system for assembly or if requirements are more restrictive. The PolyPro by DuraVent and InnoFlue by Centrotherm venting system must also follow the uninsulated.

The EL297UHV can be installed as either a Non-Direct Vent or a Direct Vent gas central furnace.

NOTE - In Non-Direct Vent installations, combustion air is taken from indoors or ventilated attic or crawlspace and flue gases are discharged outdoors. In Direct Vent installations, combustion air is taken from outdoors and flue gases are discharged outdoors.

Intake and exhaust pipe sizing -- Size pipe according to TABLE 21 (minimum) and TABLE 22 (maximum). Count all elbows inside and outside the home.

Regardless of the diameter of pipe used, the standard roof and wall terminations described in section Exhaust Piping Terminations should be used. Exhaust vent termination pipe is sized to optimize the velocity of the exhaust gas as it exits the termination. Refer to TABLE 25. In some applications which permit the use of several different sizes of vent pipe, a combination vent pipe may be used. Contact Lennox' Application Department for assistance in sizing vent pipe in these applications.

NOTE - The exhaust collar on all models is sized to accommodate 2" Schedule 40 vent pipe. In horizontal applications, any transition to exhaust pipe larger than 2" must be made in vertical runs of the pipe. Therefore a 2" elbow must be added before the pipe is transitioned to any size larger than 2". This elbow must be added to the elbow count used to determine acceptable vent lengths. Contact the Application Department for more information concerning sizing of vent systems which include multiple pipe sizes.

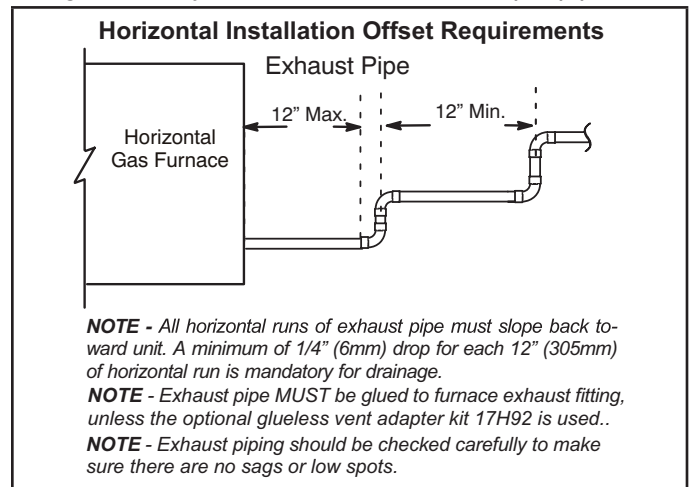

FIGURE 21

TABLE 21

MINIMUM VENT PIPE LENGTHS

EL297UHV MODEL	MIN. VENT LENGTH*
045, 070, 090, 110, 135	15 ft. or 5 ft plus 2 elbows or 10 ft plus 1 elbow

*Any approved termination may be added to the minimum length listed. Two 45 degree elbows are the equivalent to one 90 degree elbow.

NOTE - Lennox offers a glueless vent adapter kit 17H92 as an option for exhaust exiting at the furnace top cap coupling. If the kit is not used, then the exhaust pipe **MUST** be glued to the furnace exhaust fitting.

Use the following steps to correctly size vent pipe diameter.

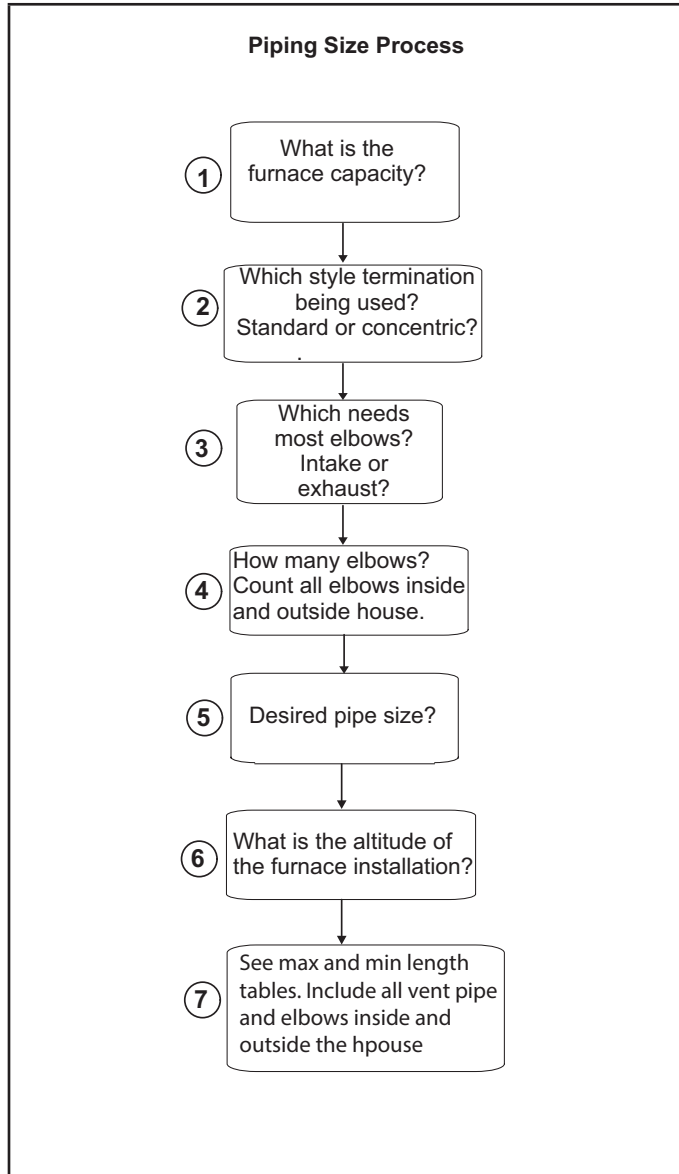

FIGURE 22

! IMPORTANT

Do not use screens or perforated metal in exhaust or intake terminations. Doing so will cause freeze-ups and may block the terminations.

TABLE 22

Maximum Allowable Intake or Exhaust Vent Length in Feet

NOTE - Size intake and exhaust pipe length separately. Values in table are for Intake OR Exhaust, not combined total. Both Intake and Exhaust must be same pipe size.

Standard Termination at Elevation 0 - 4500 ft																				
No Of 90° Elbows Used	1-1/2" Pipe					2" Pipe					2-1/2" Pipe					3" Pipe				
	Model					Model					Model					Model				
	045	070	090	110	135	045	070	090	110	135	045	070	090	110	135	045	070	090	110	135
1	25	20	n/a	n/a	n/a	81	66	44	22	n/a	115	115	93	58	n/a	138	137	118	118	114
2	20	15				76	61	39	19		110	110	88	53		133	132	113	113	109
3	15	10				71	56	34	14		105	105	83	48		128	127	108	108	104
4	10	n/a				66	51	29	n/a		100	100	78	43		123	122	103	103	99
5	n/a					61	46	24			95	95	73	38		118	117	98	98	94
6						56	41	19			90	90	68	33		113	112	93	93	89
7						51	36	14			85	85	63	28		108	107	88	88	84
8						46	31	n/a			80	80	58	23		103	102	83	83	79
9						41	26				75	75	53	18		98	97	78	78	74
10		36				21	70		70		48	13	93	92		73	73	69		
Standard Termination Elevation 4500 - 10,000 ft																				
No Of 90° Elbows Used	1-1/2" Pipe					2" Pipe					2-1/2" Pipe					3" Pipe				
	Model					Model					Model					Model				
	045	070	090	110	135	045	070	090	110	135	045	070	090	110	135	045	070	090	110	135
1	25	20	n/a	n/a	n/a	81	66	44	n/a	n/a	115	115	93	58	n/a	138	137	118	118	114
2	20	15				76	61	39			110	110	88	53		133	132	113	113	109
3	15	10				71	56	34			105	105	83	48		128	127	108	108	104
4	10	n/a				66	51	29			100	100	78	43		123	122	103	103	99
5	n/a					61	46	24			95	96	73	38		118	117	98	98	94
6						56	41	19			90	90	68	33		113	112	93	93	89
7						51	36	14			85	85	63	28		108	107	88	88	84
8						46	31	n/a			80	80	58	23		103	102	83	83	79
9						41	26				75	75	53	18		98	97	78	78	74
10		36				21	70				70	48	13	93		92	73	73	69	

TABLE 22 Continued

Maximum Allowable Intake or Exhaust Vent Length in Feet

NOTE - Size intake and exhaust pipe length separately. Values in table are for Intake OR Exhaust, not combined total. Both Intake and Exhaust must be same pipe size.

Concentric Termination at Elevation 0 - 4500 ft																				
No Of 90° Elbows Used	1-1/2" Pipe					2" Pipe					2-1/2" Pipe					3" Pipe				
	Model					Model					Model					Model				
	045	070	090	110	135	045	070	090	110	135	045	070	090	110	135	045	070	090	110	135
1	20	15				73	58	42	22		105	105	89	54		121	121	114	114	105
2	15	10				68	53	37	17		100	100	84	49		116	116	109	109	100
3	10					63	48	32	12		95	95	79	44		111	111	104	104	95
4						58	43	27			90	90	74	39		106	106	99	99	90
5						53	38	22			85	85	69	34		101	101	94	94	85
6			n/a	n/a	n/a	48	33	17			80	80	64	29		96	96	89	89	80
7	n/a	n/a				43	28	12	n/a		75	75	59	24		91	91	84	84	75
8						38	23				70	70	54	19		86	86	79	79	70
9						33	18	n/a			65	65	49	14		81	81	74	74	65
10						28	13				60	60	44	n/a		76	76	69	69	60
Concentric Termination Elevation 4500 - 10,000 ft																				
No Of 90° Elbows Used	1-1/2" Pipe					2" Pipe					2-1/2" Pipe					3" Pipe				
	Model					Model					Model					Model				
	045	070	090	110	135	045	070	090	110	135	045	070	090	110	135	045	070	090	110	135
1	20	15				73	58	42			105	105	89	54		121	121	114	114	105
2	15	10				68	53	37			100	100	84	49		116	116	109	109	100
3	10					63	48	32			95	95	79	44		111	111	104	104	95
4						58	43	27			90	90	74	39		106	106	99	99	90
5						53	38	22			85	85	69	34		101	101	94	94	85
6			n/a	n/a	n/a	48	33	17			80	80	64	29		96	96	89	89	80
7	n/a	n/a				43	28	12			75	75	59	24		91	91	84	84	75
8						38	23				70	70	54	19		86	86	79	79	70
9						33	18	n/a			65	65	49	14		81	81	74	74	65
10						28	13				60	60	44	n/a		76	76	69	69	60

TABLE 23

Maximum Allowable Exhaust Vent Lengths With Furnace Installed in a Closet or Basement Using Ventilated Attic or Crawl Space For Intake Air in Feet

NOTE - Size intake and exhaust pipe length separately. Values in table are for Intake OR Exhaust, not combined total. Both Intake and Exhaust must be same pipe size.

NOTE - Additional vent pipe and elbows used to terminate the vent pipe outside the structure must be included in the total vent length calculation

Standard Termination at Elevation 0 - 4500 ft																						
No Of 90° Elbows Used	1-1/2" Pipe					2" Pipe					2-1/2" Pipe					3" Pipe						
	Model					Model					Model					Model						
	045	070	090	110	135	045	070	090	110	135	045	070	090	110	135	045	070	090	110	135		
1	20	15	n/a	n/a	n/a	71	56	34	14	n/a	100	100	78	43	n/a	118	117	98	98	94		
2	15	10				66	51	29	9		95	95	73	38		113	112	93	93	89		
3	10					61	46	24	4		90	90	68	33		108	107	88	88	84		
4	n/a	n/a				56	41	19	n/a		85	85	63	28		103	102	83	83	79		
5						51	36	14			80	80	58	23		98	97	78	78	74		
6	n/a	n/a				46	31	9	n/a		75	75	53	18		93	92	73	73	69		
7						41	26	4			70	70	48	13		88	87	68	68	64		
8						36	21	n/a			65	65	43	8		83	82	63	63	59		
9						31	16				60	60	38	3		78	77	58	58	54		
10						26	11		55		55	33	n/a	73		72	53	53	49			
Standard Termination Elevation 4500 - 10,000 ft																						
No Of 90° Elbows Used	1-1/2" Pipe					2" Pipe					2-1/2" Pipe					3" Pipe						
	Model					Model					Model					Model						
	045	070	090	110	135	045	070	090	110	135	045	070	090	110	135	045	070	090	110	135		
1	20	15	n/a	n/a	n/a	71	56	34	n/a	n/a	100	100	78	43	n/a	118	117	98	98	94		
2	15	10				66	51	29			95	95	73	38		113	112	93	93	89		
3	10					61	46	24			90	90	68	33		108	107	88	88	84		
4	n/a	n/a				56	41	19			n/a	n/a	85	85		63	28	103	102	83	83	79
5						51	36	14					80	80		58	23	98	97	78	78	74
6	n/a	n/a				46	31	9			n/a	n/a	75	75		53	18	93	92	73	73	69
7						41	26	4					70	70		48	13	88	87	68	68	64
8						36	21	n/a					65	65		43	8	83	82	63	63	59
9						31	16						60	60		38	3	78	77	58	58	54
10						26	11				55	55	33	n/a		73	72	53	53	49		

**TYPICAL EXHAUST AND INTAKE PIPE CONNECTIONS IN UPFLOW
DIRECT OR NON-DIRECT VENT APPLICATIONS**

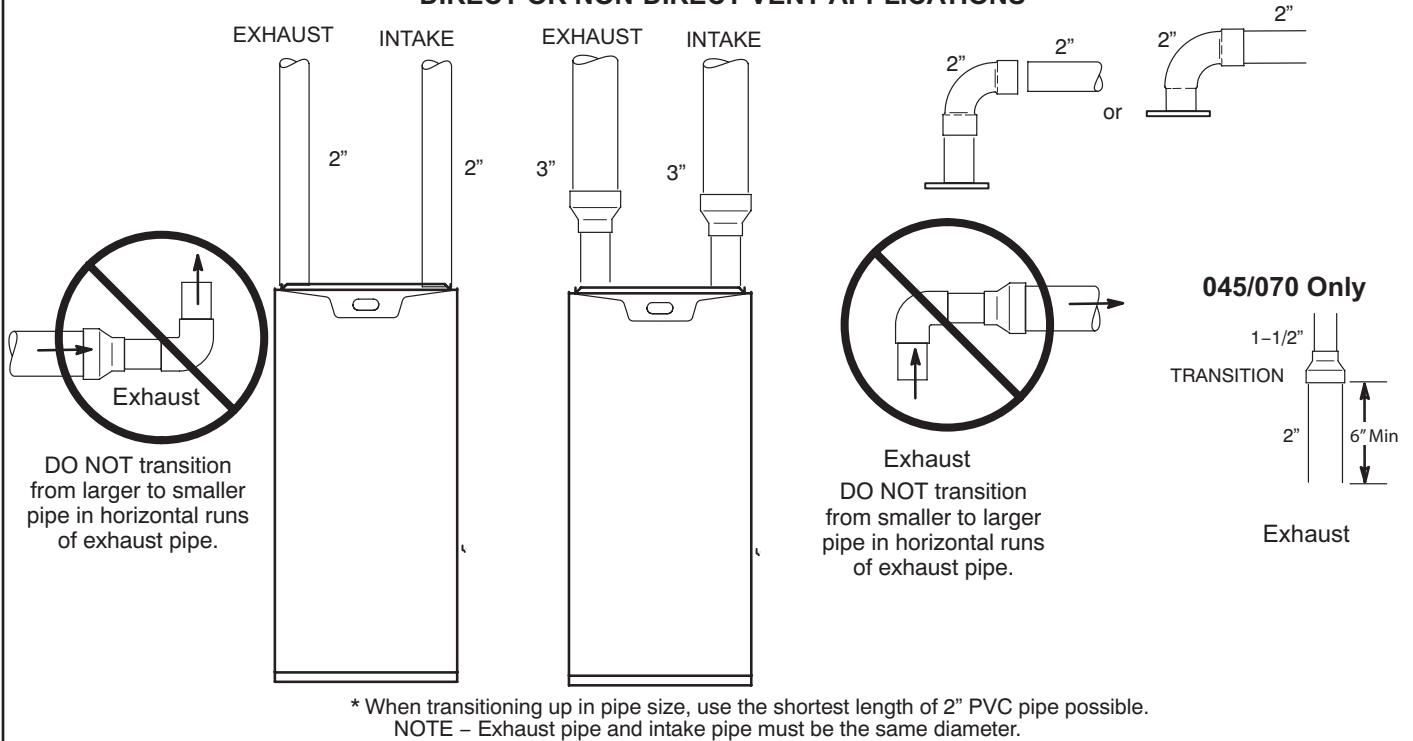

FIGURE 23

**TYPICAL EXHAUST AND INTAKE PIPE CONNECTIONS IN HORIZONTAL DIRECT OR
NON-DIRECT VENT APPLICATIONS (RIGHT HAND DISCHARGE SHOWN)**

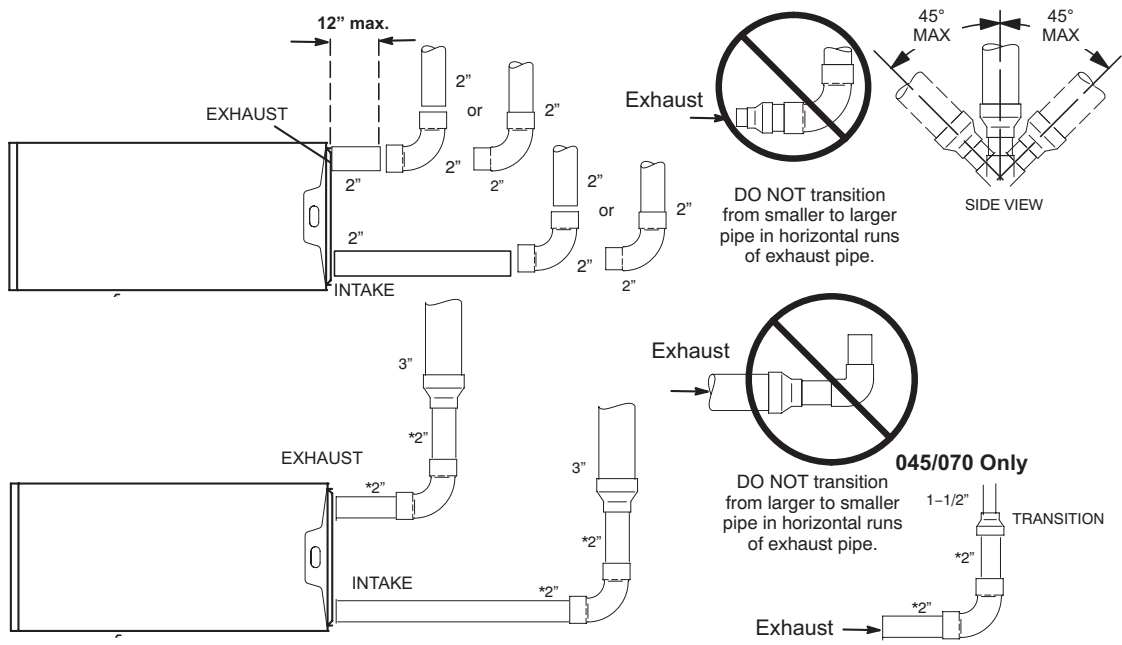

FIGURE 24

Intake Piping

The EL297UHV furnace may be installed in either **direct vent** or **non-direct vent** applications. In non-direct vent applications, when intake air will be drawn into the furnace from the surrounding space, the indoor air quality must be considered and guidelines listed in Combustion, Dilution and Ventilation Air section must be followed.

Follow the next two steps when installing the unit in **Direct Vent applications**, where combustion air is taken from outdoors and flue gases are discharged outdoors. **The provided air intake screen must not be used in direct vent applications (outdoors).**

- 1 - Use transition solvent cement or a sheet metal screw to secure the intake pipe to the inlet air connector.
- 2 - Route piping to outside of structure. Continue with installation following instructions given in general guidelines for piping terminations and intake and exhaust piping terminations for direct vent sections. Refer to TABLE 22 for pipe sizes.

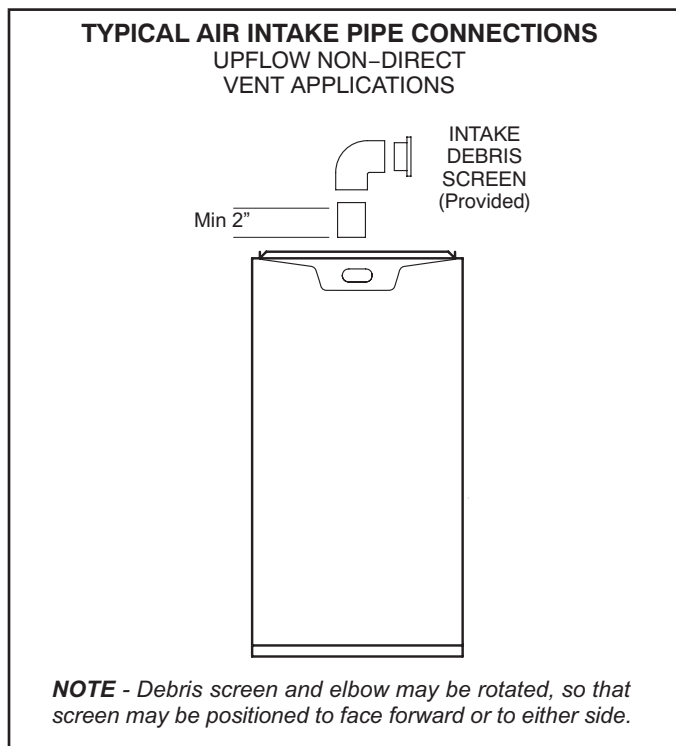

FIGURE 25

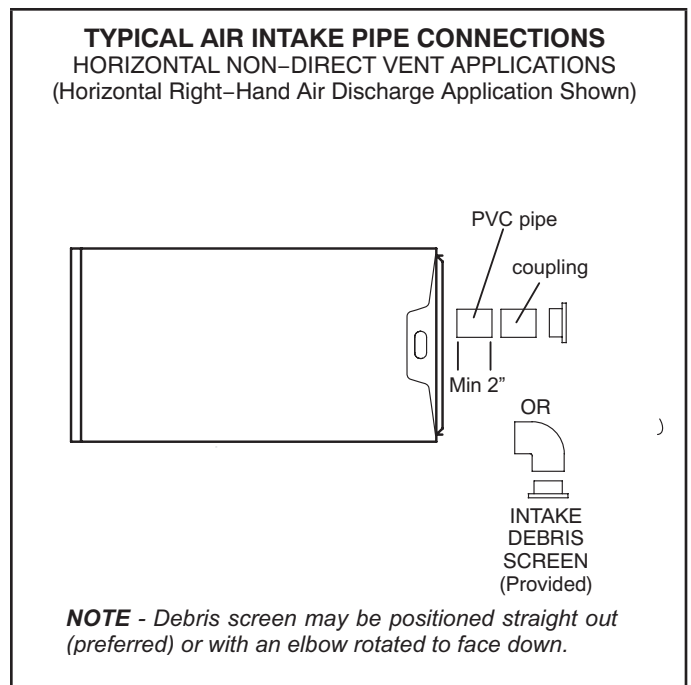

FIGURE 26

Follow the next two steps when installing the unit in **Non-Direct Vent applications** where combustion air is taken from indoors or ventilated attic or crawlspace and flue gases are discharged outdoors.

- 1 - Use field-provided materials and the factory-provided air intake screen to route the intake piping as shown in FIGURE 25 and FIGURE 26. Maintain a minimum clearance of 3" (76mm) around the air intake opening. The air intake opening (with the protective screen) should always be directed forward or to either side in the upflow position, and either straight out or downward in the horizontal position.

The air intake piping must not terminate too close to the flooring or a platform. Ensure that the intake air inlet will not be obstructed by loose insulation or other items that may clog the debris screen.

- 2 - If intake air is drawn from a ventilated attic (FIGURE 27) or ventilated crawlspace (FIGURE 28) the exhaust vent length must not exceed those listed in TABLE 23. If 3" diameter pipe is used, reduce to 2" diameter pipe at the termination point to accommodate the debris screen.
- 3 - Use a sheet metal screw to secure the intake pipe to the connector, if desired.

⚠ CAUTION

If this unit is being installed in an application with combustion air coming in from a space serviced by an exhaust fan, power exhaust fan, or other device which may create a negative pressure in the space, take care when sizing the inlet air opening. The inlet air opening must be sized to accommodate the maximum volume of exhausted air as well as the maximum volume of combustion air required for all gas appliances serviced by this space.

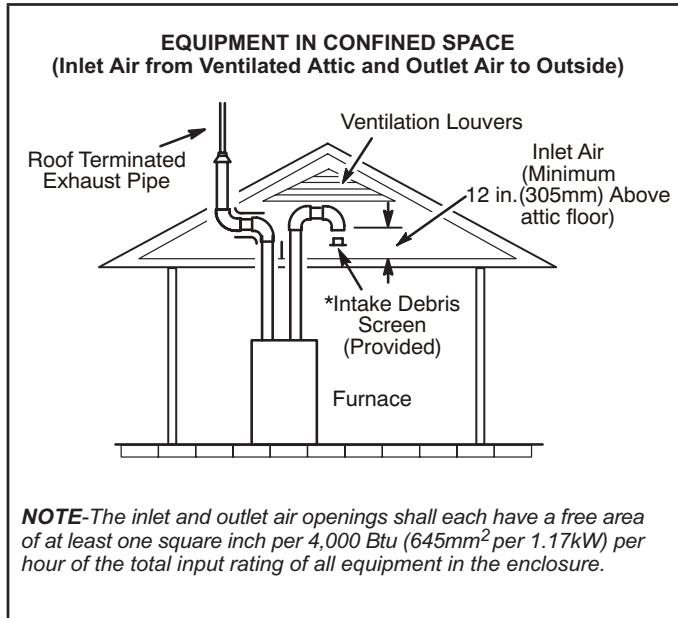

FIGURE 27

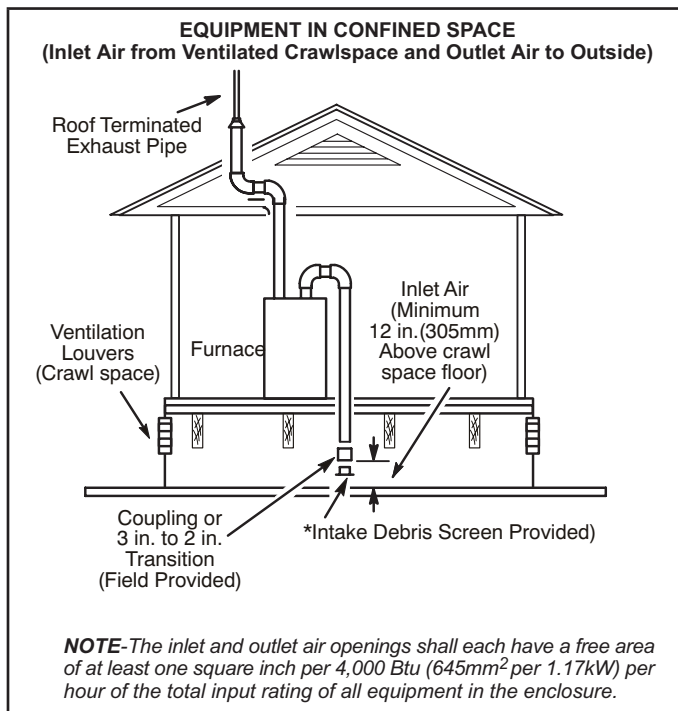

FIGURE 28

General Guidelines for Vent Terminations

In Non-Direct Vent applications, combustion air is taken from indoors or ventilated attic or crawlspace and the flue gases are discharged to the outdoors. The EL297UHV is then classified as a non-direct vent, Category IV gas furnace.

In Direct Vent applications, combustion air is taken from outdoors and the flue gases are discharged to the outdoors. The EL297UHV is then classified as a direct vent, Category IV gas furnace.

In both Non-Direct Vent and Direct Vent applications, the vent termination is limited by local building codes. In the absence of local codes, refer to the current National Fuel Gas Code ANSI Z223-1/NFPA 54 in U.S.A., and current CSA-B149 Natural Gas and Propane Installation Codes in Canada for details.

Position termination according to location given in FIGURE 30 or FIGURE 31. In addition, position termination so it is free from any obstructions and 12" above the average snow accumulation.

At vent termination, care must be taken to maintain protective coatings over building materials (prolonged exposure to exhaust condensate can destroy protective coatings). It is recommended that the exhaust outlet not be located within 6 feet (1.8m) of an outdoor AC unit because the condensate can damage the painted coating.

NOTE - See TABLE 24 for maximum allowed exhaust pipe length without insulation in unconditioned space during winter design temperatures below 32°F (0°C). If required exhaust pipe should be insulated with 1/2" (13mm) Armaflex or equivalent. In extreme cold climate areas, 3/4" (19mm) Armaflex or equivalent may be necessary. Insulation must be protected from deterioration. Armaflex with UV protection is permissible. Basements or other enclosed areas that are not exposed to the outdoor ambient temperature and are above 32 degrees F (0°C) are to be considered conditioned spaces.

⚠ IMPORTANT

Do not use screens or perforated metal in exhaust or intake terminations. Doing so will cause freeze-ups and may block the terminations.

⚠ IMPORTANT

For Canadian Installations Only:

In accordance to CSA International B149 installation codes, the minimum allowed distance between the combustion air intake inlet and the exhaust outlet of other appliances shall not be less than 12 inches (305mm).

TABLE 24

Maximum Allowable Exhaust Vent Pipe Length (in ft.³) Without Insulation In Unconditioned Space For Winter Design Temperatures Two - Stage High Efficiency Furnace

Winter Design Temperatures ¹ °F (°C)	Vent Pipe Diameter	Unit Input Size									
		045		070		090		110		135	
		PVC	² PP	PVC	² PP	PVC	² PP	PVC	² PP	PVC	² PP
32 to 21 (0 to -6)	1-1/2	22	n/a	25	n/a	n/a	n/a	n/a	n/a	n/a	n/a
	2 in	21	18	33	30	46	42	30	30	n/a	n/a
	2-1/2 in	16	n/a	26	n/a	37	n/a	36	n/a	n/a	n/a
	3 in	12	12	21	21	30	30	29	29	42	42
20 to 1 (-7 to -17)	1-1/2	12	n/a	20	n/a	n/a	n/a	n/a	n/a	n/a	n/a
	2 in	11	9	19	17	28	25	27	24	n/a	n/a
	2-1/2 in	7	n/a	14	n/a	21	n/a	20	n/a	n/a	n/a
	3 in	2	2	9	9	16	16	14	14	23	23
0 to -20 (-18 to -29)	1-1/2	8	n/a	13	n/a	n/a	n/a	n/a	n/a	n/a	n/a
	2 in	6	4	12	10	19	16	18	15	n/a	n/a
	2-1/2 in	1	n/a	7	n/a	13	n/a	12	n/a	n/a	n/a
	3 in	1	1	2	2	8	8	7	7	13	13

¹Refer to 99% Minimum Design Temperature table provided in the current edition of the ASHRAE Fundamentals Handbook.

² Poly-Propylene vent pipe (PP) by Duravent and Centrotherm.

³ Vent length in table is equivalent length. Consider each elbow as 5ft. of linear length

NOTE - Concentric terminations are the equivalent of 5' and should be considered when measuring pipe length.

NOTE - Maximum uninsulated vent lengths listed may include the termination(vent pipe exterior to the structure) and cannot exceed 5 linear feet or the maximum allowable intake or exhaust vent length listed in TABLE 22 or TABLE 23 which ever is less.

NOTE - If insulation is required in an unconditioned space, it must be located on the pipe closest to the furnace. See FIGURE 29.

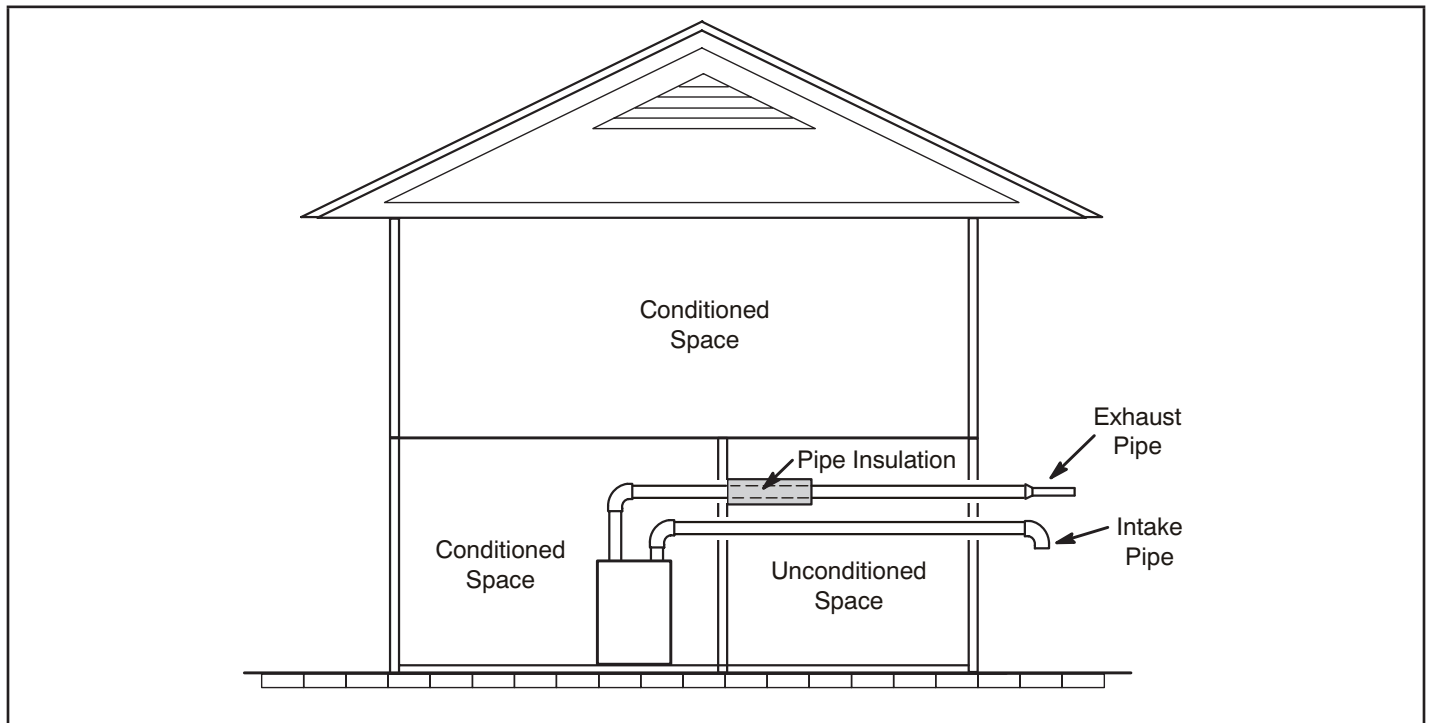
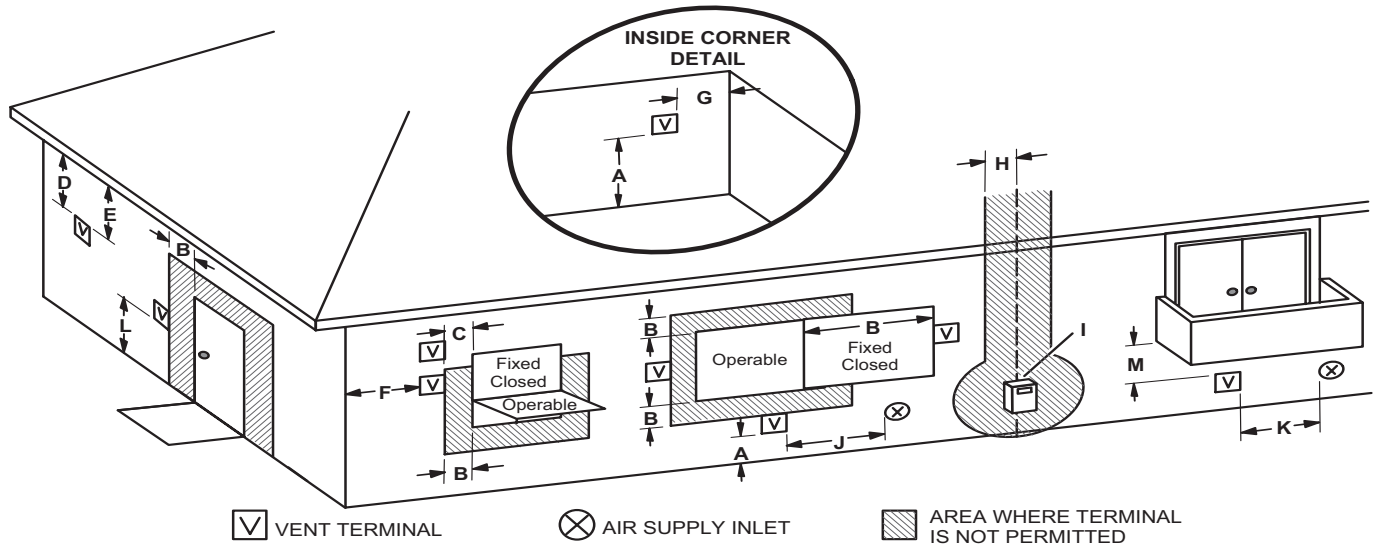

FIGURE 29

VENT TERMINATION CLEARANCES FOR NON-DIRECT VENT INSTALLATIONS IN THE USA AND CANADA



	US Installations ¹	Canadian Installations ²	
A =	Clearance above grade, veranda, porch, deck or balcony	12 inches (305mm) or 12 in. (305mm) above average snow accumulation.	12 inches (305mm) or 12 in. (305mm) above average snow accumulation.
B =	Clearance to window or door that may be opened	4 feet (1.2 m) below or to side of opening; 1 foot (30cm) above opening	6 inches (152mm) for appliances <10,000 Btuh (3kw), 12 inches (305mm) for appliances > 10,000 Btuh (3kw) and <100,000 Btuh (30kw), 36 inches (.9m) for appliances > 100,000 Btuh (30kw)
C =	Clearance to permanently closed window	* 12"	* 12"
D =	Vertical clearance to ventilated soffit located above the terminal within a horizontal distance of 2 feet (610 mm) from the center line of the terminal	* Equal to or greater than soffit depth.	* Equal to or greater than soffit depth.
E =	Clearance to unventilated soffit	* Equal to or greater than soffit depth.	* Equal to or greater than soffit depth.
F =	Clearance to outside corner	* No minimum to outside corner	* No minimum to outside corner
G =	Clearance to inside corner	*	*
H =	Clearance to each side of center line extended above meter / regulator assembly	* 3 feet (.9m) within a height 15 feet (4.5m) above the meter / regulator assembly	3 feet (.9m) within a height 15 feet (4.5m) above the meter / regulator assembly
I =	Clearance to service regulator vent outlet	* 3 feet (.9m)	3 feet (.9m)
J =	Clearance to non-mechanical air supply inlet to building or the combustion air inlet to any other appliance	4 feet (1.2 m) below or to side of opening; 1 foot (30 cm) above opening	6 inches (152mm) for appliances <10,000 Btuh (3kw), 12 inches (305mm) for appliances > 10,000 Btuh (3kw) and <100,000 Btuh (30kw), 36 inches (.9m) for appliances > 100,000 Btuh (30kw)
K =	Clearance to mechanical air supply inlet	3 feet (.9m) above if within 10 feet (3m) horizontally	6 feet (1.8m)
L =	Clearance above paved sidewalk or paved driveway located on public property	7 feet (2.1m)†	7 feet (2.1m)†
M =	Clearance under veranda, porch, deck or balcony	*12 inches (305mm)‡	12 inches (305mm)‡

¹ In accordance with the current ANSI Z223.1/NFPA 54 Natural Fuel Gas Code

² In accordance with the current CSA B149.1, Natural Gas and Propane Installation Code
 † A vent shall not terminate directly above a sidewalk or paved driveway that is located between two single family dwellings and serves both dwellings.

‡ Permitted only if veranda, porch, deck or balcony is fully open on a minimum of two sides beneath the floor. Lennox recommends avoiding this location if possible.

For clearances not specified in ANSI Z223.1/NFPA 54 or CSA B149.1, clearance will be in accordance with local installation codes and the requirements of the gas supplier and these installation instructions.

NOTE - This figure is intended to illustrate clearance requirement and does not serve as a substitute for locally adopted installation codes.

FIGURE 30

VENT TERMINATION CLEARANCES FOR DIRECT VENT INSTALLATIONS IN THE US AND CANADA

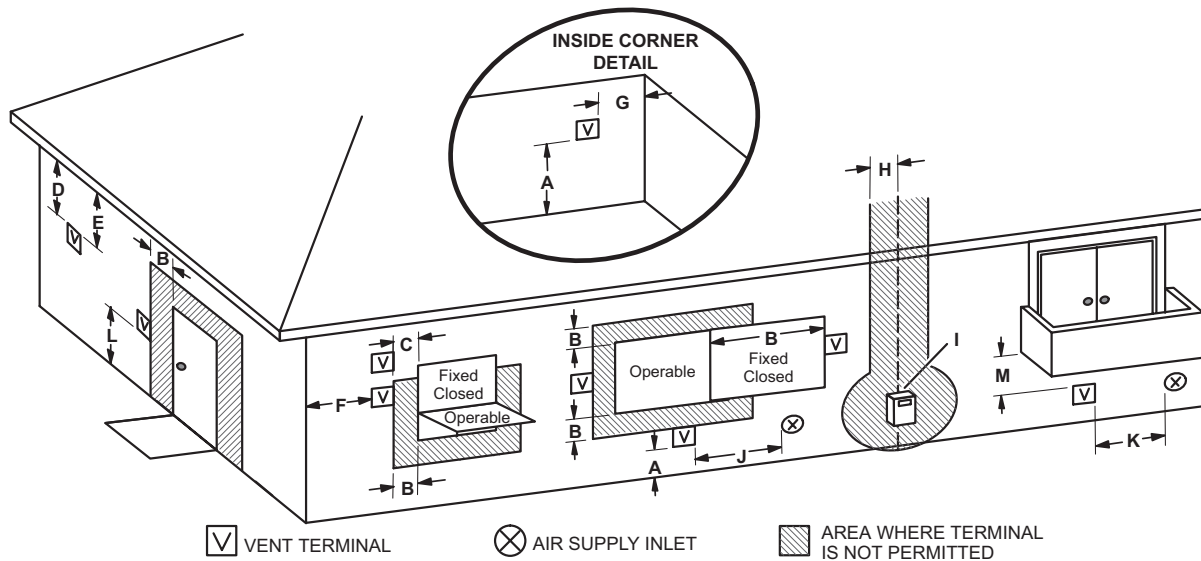

	US Installations ¹	Canadian Installations ²	
A =	Clearance above grade, veranda, porch, deck or balcony	12 inches (305mm) or 12 in. (305mm) above average snow accumulation.	12 inches (305mm) or 12 in. (305mm) above average snow accumulation.
B =	Clearance to window or door that may be opened	6 inches (152mm) for appliances <10,000 Btuh (3kw), 9 inches (228mm) for appliances > 10,000 Btuh (3kw) and <50,000 Btuh (15 kw), 12 inches (305mm) for appliances > 50,000 Btuh (15kw)	6 inches (152mm) for appliances <10,000 Btuh (3kw), 12 inches (305mm) for appliances > 10,000 Btuh (3kw) and <100,000 Btuh (30kw), 36 inches (.9m) for appliances > 100,000 Btuh (30kw)
C =	Clearance to permanently closed window	* 12"	* 12"
D =	Vertical clearance to ventilated soffit located above the terminal within a horizontal distance of 2 feet (610mm) from the center line of the terminal	* Equal to or greater than soffit depth	* Equal to or greater than soffit depth
E =	Clearance to unventilated soffit	* Equal to or greater than soffit depth	* Equal to or greater than soffit depth
F =	Clearance to outside corner	* No minimum to outside corner	* No minimum to outside corner
G =	Clearance to inside corner	*	*
H =	Clearance to each side of center line extended above meter / regulator assembly	3 feet (.9m) within a height 15 feet (4.5m) above the meter / regulator assembly	3 feet (.9m) within a height 15 feet (4.5m) above the meter / regulator assembly
I =	Clearance to service regulator vent outlet	* 3 feet (.9m)	3 feet (.9m)
J =	Clearance to non-mechanical air supply inlet to building or the combustion air inlet to any other appliance	6 inches (152mm) for appliances <10,000 Btuh (3kw), 9 inches (228mm) for appliances > 10,000 Btuh (3kw) and <50,000 Btuh (15 kw), 12 inches (305mm) for appliances > 50,000 Btuh (15kw)	6 inches (152mm) for appliances <10,000 Btuh (3kw), 12 inches (305mm) for appliances > 10,000 Btuh (3kw) and <100,000 Btuh (30kw), 36 inches (.9m) for appliances > 100,000 Btuh (30kw)
K =	Clearance to mechanical air supply inlet	3 feet (.9m) above if within 10 feet (3m) horizontally	6 feet (1.8m)
L =	Clearance above paved sidewalk or paved driveway located on public property	* 7 feet (2.1m)	7 feet (2.1m)†
M =	Clearance under veranda, porch, deck or balcony	*12 inches (305mm)‡	12 inches (305mm)‡

¹ In accordance with the current ANSI Z223.1/NFPA 54 Natural Fuel Gas Code

² In accordance with the current CSA B149.1, Natural Gas and Propane Installation Code

† A vent shall not terminate directly above a sidewalk or paved driveway that is located between two single family dwellings and serves both dwellings.

‡ Permitted only if veranda, porch, deck or balcony is fully open on a minimum of two sides beneath the floor. Lennox recommends avoiding this location if possible.

*For clearances not specified in ANSI Z223.1/NFPA 54 or CSA B149.1, clearance will be in accordance with local installation codes and the requirements of the gas supplier and these installation instructions."

NOTE - This figure is intended to illustrate clearance requirements and does not serve as a substitute for locally adopted installation codes.

FIGURE 31

Details of Intake and Exhaust Piping Terminations for Direct Vent Installations

NOTE - In Direct Vent installations, combustion air is taken from outdoors and flue gases are discharged to outdoors.

NOTE - Flue gas may be slightly acidic and may adversely affect some building materials. If any vent termination is used and the flue gasses may impinge on the building material, a corrosion-resistant shield (minimum 24 inches square) should be used to protect the wall surface. If the optional tee is used, the protective shield is recommended. The shield should be constructed using wood, plastic, sheet metal or other suitable material. All seams, joints, cracks, etc. in the affected area should be sealed using an appropriate sealant. See FIGURE 35.

Intake and exhaust pipes may be routed either horizontally through an outside wall or vertically through the roof. In attic or closet installations, vertical termination through the roof is preferred. FIGURE 32 through FIGURE 40 show typical terminations.

- 1 - Intake and exhaust terminations are not required to be in the same pressure zone. You may exit the intake on one side of the structure and the exhaust on another side (FIGURE 33). You may exit the exhaust out the roof and the intake out the side of the structure (FIGURE 34).
- 2 - Intake and exhaust pipes should be placed as close together as possible at termination end (refer to illustrations). Maximum separation is 3" (76MM) on roof terminations and 6" (152MM) on side wall terminations.

NOTE - When venting in different pressure zones, the maximum separation requirement of intake and exhaust pipe DOES NOT apply.

- 3 - On roof terminations, the intake piping should terminate straight down using two 90° elbows (FIGURE 32).
- 4 - Exhaust piping must terminate straight out or up as shown. A reducer may be required on the exhaust piping at the point where it exits the structure to improve the velocity of exhaust away from the intake piping. See TABLE 25.

NOTE - Care must be taken to avoid recirculation of exhaust back into intake pipe.

- 5 - On field-supplied terminations for side wall exit, exhaust piping may extend a maximum of 12 inches (305MM) for 2" PVC and 20 inches (508MM) for 3" (76MM) PVC beyond the outside wall. Intake piping should be as short as possible. See FIGURE 35.
- 6 - On field-supplied terminations, a minimum distance between the end of the exhaust pipe and the end of the intake pipe without a termination elbow is 8" and a minimum distance of 6" with a termination elbow. See FIGURE 35.
- 7 - If intake and exhaust piping must be run up a side wall to position above snow accumulation or other obstructions, piping must be supported. At least one bracket must be used within 6" from the top of the elbow and then every 24" (610mm) as shown in FIGURE 35, to prevent any movement in any direction. When exhaust and intake piping must be run up an outside wall, the exhaust piping must be terminated with pipe sized per TABLE 25 The intake piping may be equipped with a 90° elbow turndown. Using turndown will add 5 feet (1.5m) to the equivalent length of the pipe.

- 8 - A multiple furnace installation may use a group of up to four terminations assembled together horizontally, as shown in FIGURE 39.

TABLE 25

EXHAUST PIPE TERMINATION SIZE REDUCTION

EL297UHV MODEL	Termination Pipe Size
*045 and 070	1-1/2" (38MM)
*090	2" (51MM)
110	2" (51MM)
135	2" (51MM)

*EL297UHV-045, -070 and -090 units with the flush mount termination must use the 1-1/2" accelerator supplied with the kit.

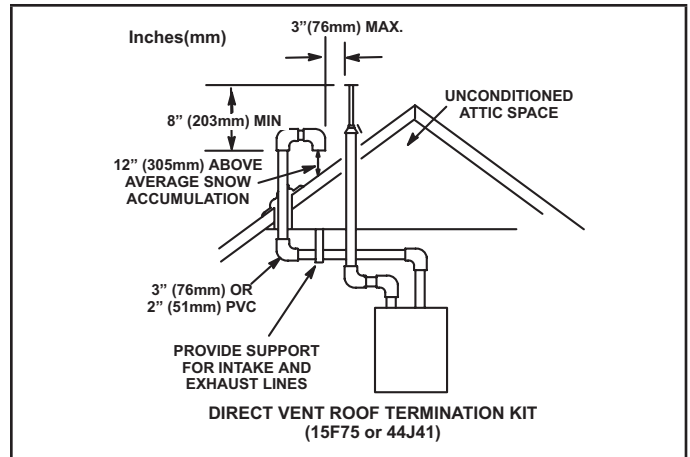

FIGURE 32

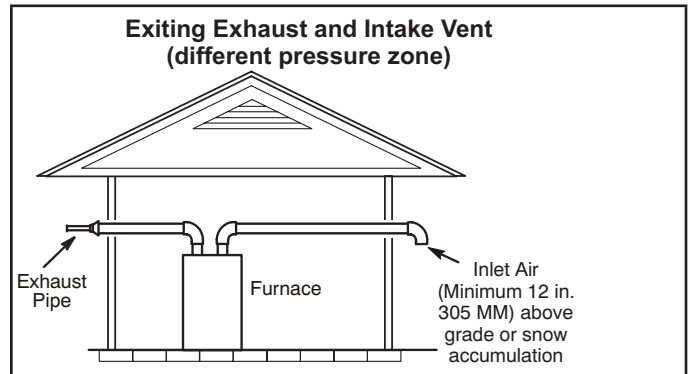

FIGURE 33

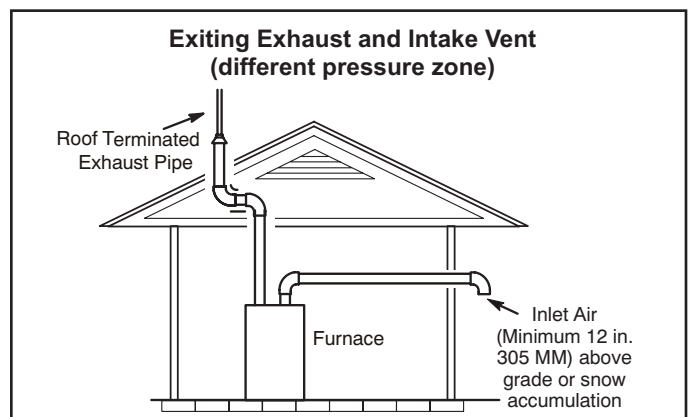
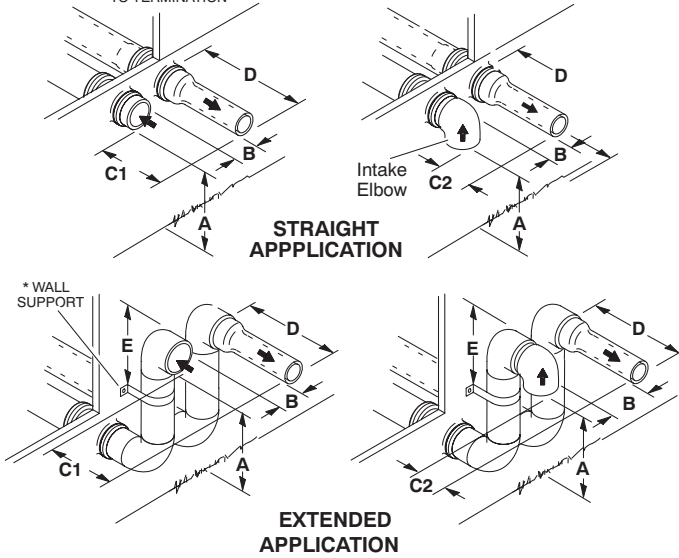

FIGURE 34

NOTE – FIELD-PROVIDED REDUCER MAY BE REQUIRED TO ADAPT LARGER VENT PIPE SIZE TO TERMINATION

FIELD FABRICATED WALL TERMINATION



	2" (51mm) Vent Pipe	3" (76mm) Vent Pipe
A – Minimum clearance above grade or average snow accumulation	12" (305 mm)	12" (305 mm)
B – Maximum horizontal separation between intake and exhaust	6" (152 mm)	6" (152 mm)
C1 – Minimum from end of exhaust to inlet of intake	8" (203 mm)	8" (203 mm)
C2 – Minimum from end of exhaust to inlet of intake	6" (152 mm)	6" (152 mm)
D – Maximum exhaust pipe length	12" (305 mm)	20" (508 mm)
E – Maximum wall support distance from top of each pipe (intake/exhaust)	6" (152 mm)	6" (152 mm)

See maximum allowable venting tables for venting lengths with this arrangement.

* Use wall support every 24" (610 mm). Use two wall supports if extension is greater than 24" (610 mm) but less than 48" (1219 mm).

NOTE – One wall support must be within 6" (152 mm) from top of each pipe (intake and exhaust) to prevent movement in any direction.

ALTERNATE TERMINATIONS (TEE & FORTY-FIVE DEGREE ELBOWS ONLY)

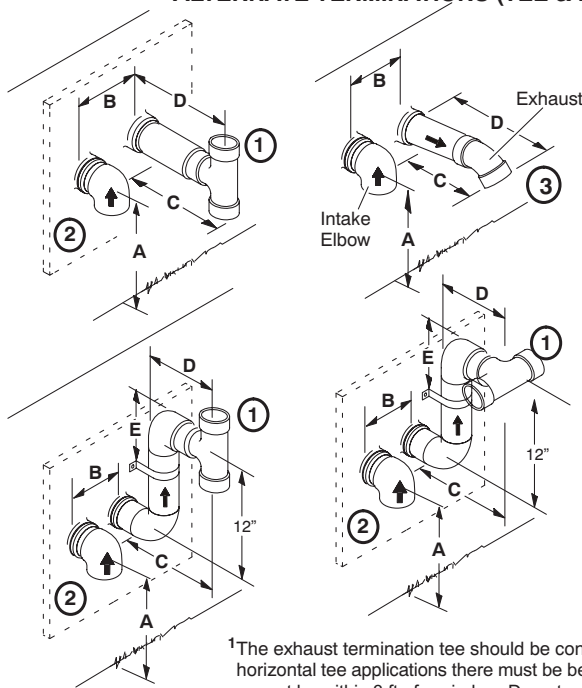

	2" (51mm) Vent Pipe	3" (76mm) Vent Pipe
A – Clearance above Grade or average snow accumulation	12" (305 mm) Min	12" (305 mm) Min
B – Horizontal separation between intake and exhaust	6" (152mm)min 24" (610mm)Max	6" (152mm)min 24" (610mm)Max
C – Minimum from end of exhaust to inlet of intake	9" (227mm)	9" (227mm)
D – Exhaust pipe length	12" (305mm)min 16" (405mm)Max	12" (305mm)min 16" (405mm)Max
E – Wall support distance from top of each pipe (intake/exhaust)	6" (152mm) Max	6" (152mm) Max

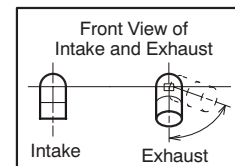

¹The exhaust termination tee should be connected to the 2" or 3" PVC flue pipe as shown in the illustration. In horizontal tee applications there must be a minimum of 3 ft away from covered patios or any living areas and cannot be within 3 ft of a window. Do not use an accelerator in applications that include an exhaust termination tee. The accelerator is not required.

²As required. Flue gas may be acidic and may adversely affect some building materials. If a side wall vent termination is used and flue gases will impinge on the building materials, a corrosion-resistant shield (24 inches square) should be used to protect the wall surface. If optional tee is used, the protective shield is recommended. The shield should be constructed using wood, sheet metal or other suitable material. All seams, joints, cracks, etc. in affected area, should be sealed using an appropriate sealant.

³Exhaust pipe 45° elbow can be rotated to the side away from the combustion air inlet to direct exhaust away from adjacent property. The exhaust must never be directed toward the combustion air inlet.

FIGURE 35

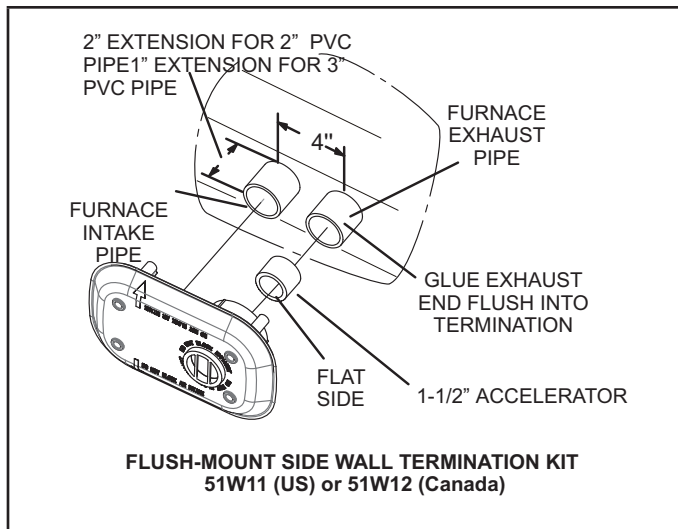

FIGURE 36

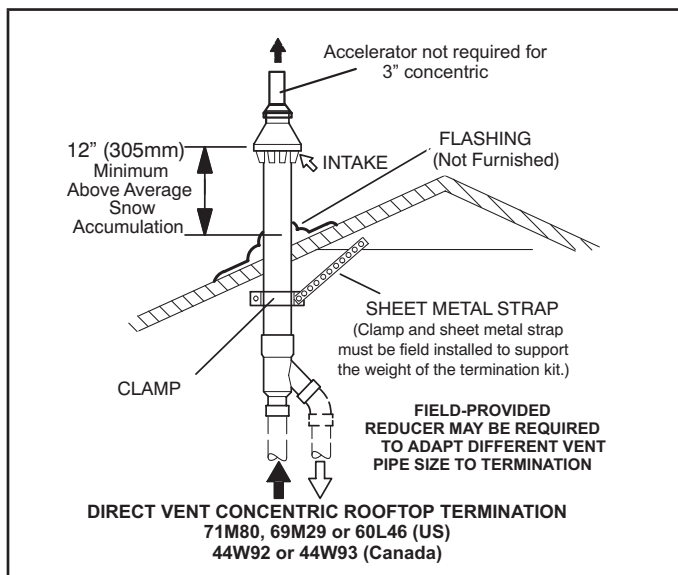

FIGURE 37

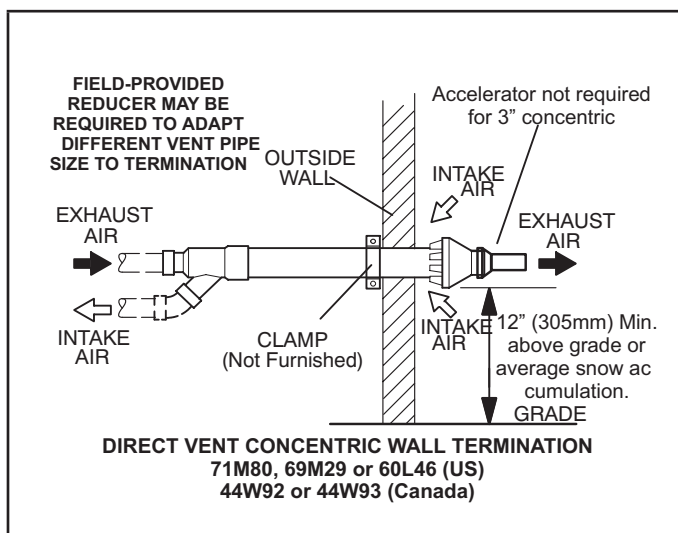

FIGURE 38

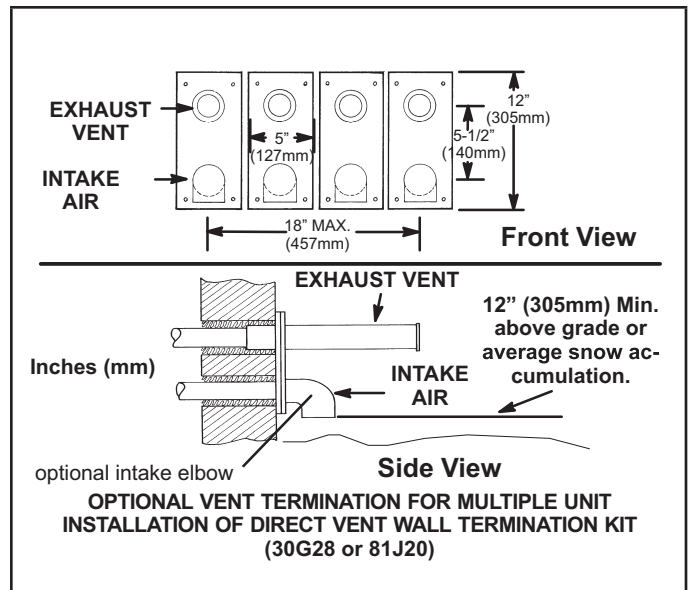

FIGURE 39

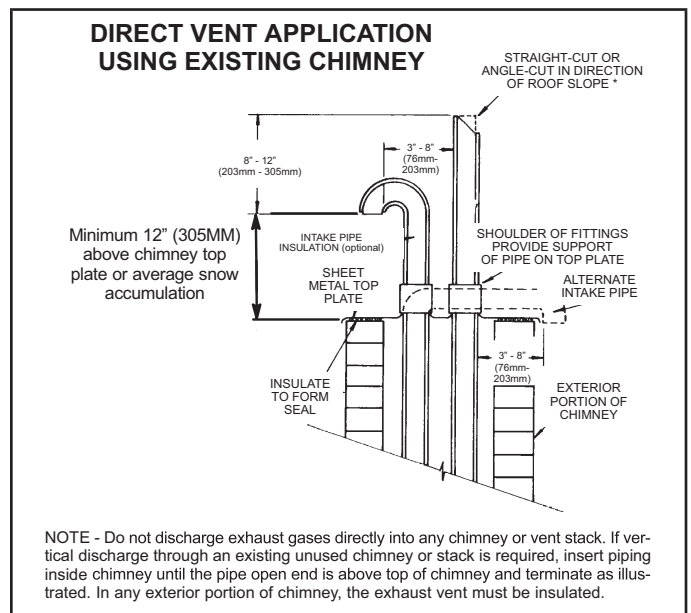

FIGURE 40

Details of Exhaust Piping Terminations for Non-Direct Vent Applications

Exhaust pipes may be routed either horizontally through an outside wall or vertically through the roof. In attic or closet installations, vertical termination through the roof is preferred. FIGURE 41 and FIGURE 42 show typical terminations.

- 1 - Exhaust piping must terminate straight out or up as shown. The termination pipe must be sized as listed in TABLE 25. The specified pipe size ensures proper velocity required to move the exhaust gases away from the building.

- 2 - On field supplied terminations for side wall exit, exhaust piping may extend a maximum of 12 inches (305MM) for 2" PVC and 20 inches (508MM) for 3" (76MM) PVC beyond the outside wall.
- 3 - If exhaust piping must be run up a side wall to position above snow accumulation or other obstructions, piping must be supported every 24 inches (610MM). When exhaust piping must be run up an outside wall, any reduction in exhaust pipe size must be done after the final elbow.
- 4 - Distance between exhaust pipe terminations on multiple furnaces must meet local codes.

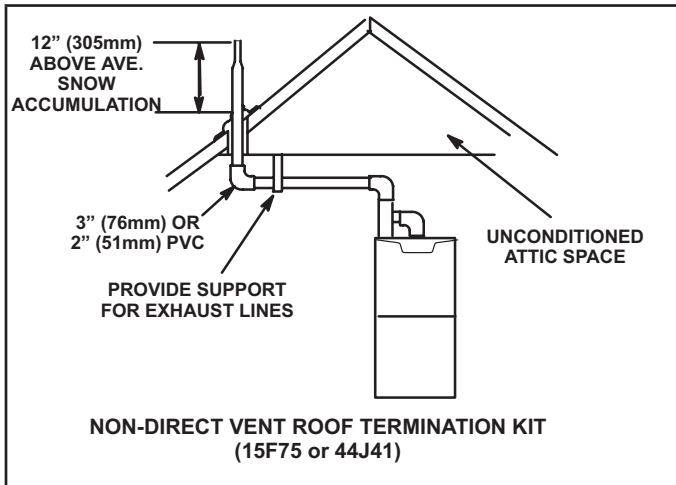

FIGURE 41

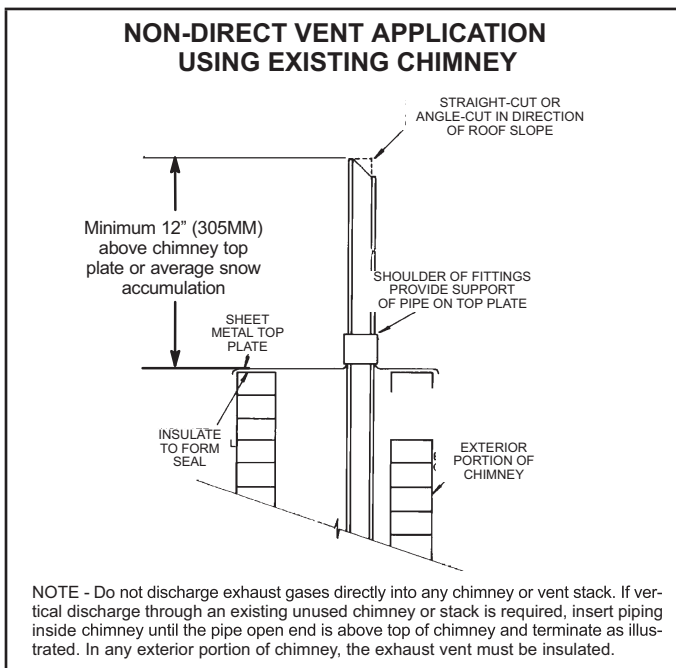

FIGURE 42

Condensate Piping

This unit is designed for either right- or left-side exit of condensate piping in upflow applications. In horizontal applications, the condensate trap must extend below the unit. An 8" service clearance is required for the condensate trap. Refer to FIGURE 43 for condensate trap locations. FIGURE 51 shows trap assembly

NOTE - If necessary the condensate trap may be installed up to 5' away from the furnace. Use PVC pipe to connect trap to furnace condensate outlet. Piping from furnace must slope down a minimum of 1/4" per ft. toward trap.

- 1 - Determine which side condensate piping will exit the unit, location of trap, field-provided fittings and length of PVC pipe required to reach available drain.
 - 2 - Use a large flat head screw driver or a 1/2" drive socket extension and remove plug (Figure 45) from the cold end header box at the appropriate location on the side of the unit. Install provided 3/4 NPT street elbow fitting into cold end header box. Use Teflon tape or appropriate pipe dope.
- NOTE -** Cold end header box drain plugs are factory installed. Check the unused plug for tightness to prevent leakage.
- 3 - Install the cap over the clean out opening at the base of the trap. Secure with clamp. See FIGURE 51.
 - 4 - Install drain trap using appropriate PVC fittings, glue all joints. Glue the provided drain trap as shown in FIGURE 55. Route the condensate line to an open drain. Condensate line must maintain a 1/4" downward slope from the furnace to the drain.

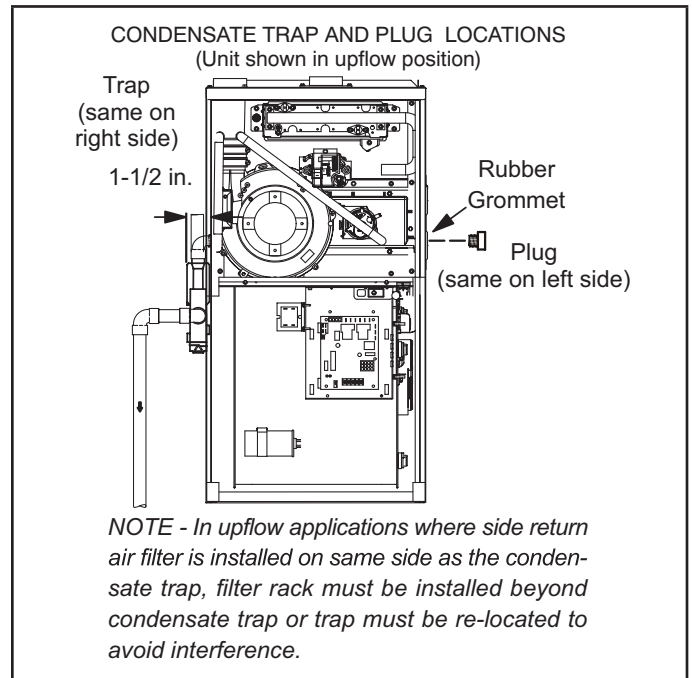

FIGURE 43

- 5 - FIGURE 46 and FIGURE 48 show the furnace and evaporator coil using a separate drain. If necessary the condensate line from the furnace and evaporator coil can drain together. See FIGURE 47, FIGURE 49 and FIGURE 50 .

Upflow furnace (FIGURE 49) - In upflow furnace applications the field provided vent must be a minimum 1" to a maximum 2" length above the condensate drain outlet connection. Any length above 2" may result in a flooded heat exchanger if the combined primary drain line were to become restricted.

Horizontal furnace (FIGURE 50) - In horizontal furnace applications the field provided vent must be a minimum 4" to a maximum 5" length above the condensate drain outlet connection. Any length above 5" may result in a flooded heat exchanger if the combined primary drain line were to become restricted.

NOTE - In horizontal applications it is recommended to install a secondary drain pan underneath the unit and trap assembly.

NOTE - Appropriately sized tubing and barbed fitting may be used for condensate drain. Attach to the drain on the trap using a hose clamp. See FIGURE 44.

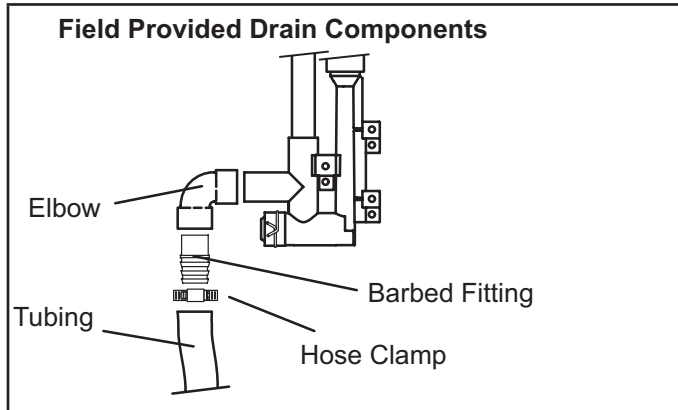

FIGURE 44

CAUTION
Do not use copper tubing or existing copper condensate lines for drain line.

6 - If unit will be started immediately upon completion of installation, prime trap per procedure outlined in Unit Start-Up section.

Condensate line must slope downward away from the trap to drain. If drain level is above condensate trap, condensate pump must be used. Condensate drain line should be routed within the conditioned space to avoid freezing of condensate and blockage of drain line. If this is not possible, a heat cable kit may be used on the condensate trap and line. Heating cable kit is available from Lennox in various lengths; 6 ft. (1.8m) - kit no. 26K68; 24 ft. (7.3m) - kit no. 26K69; and 50 ft. (15.2m) - kit no. 26K70.

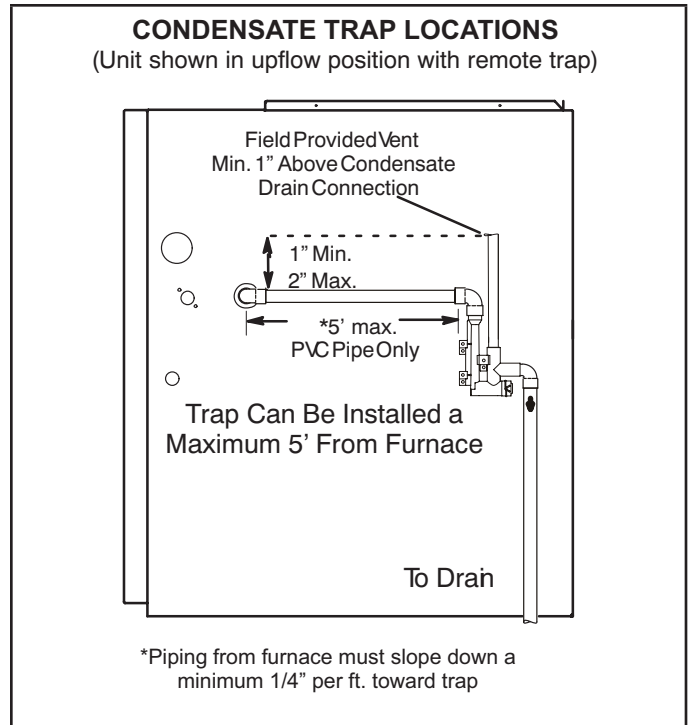

FIGURE 45

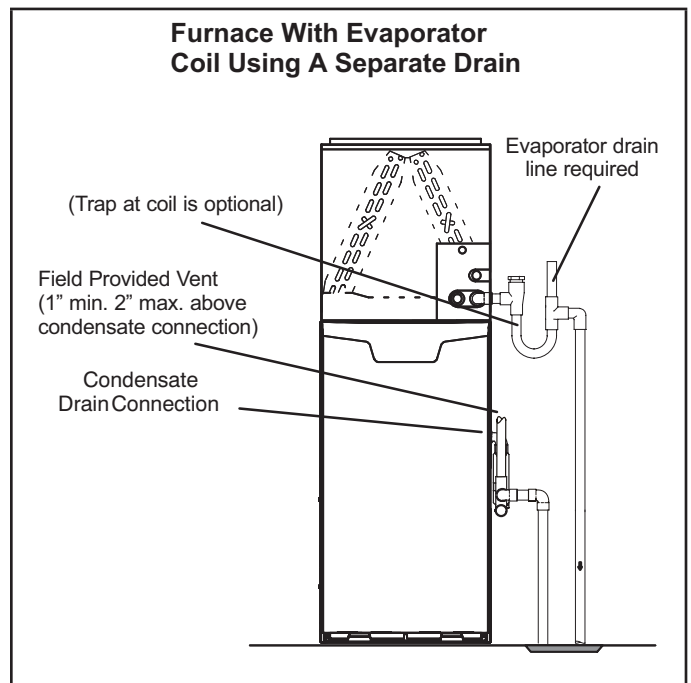

FIGURE 46

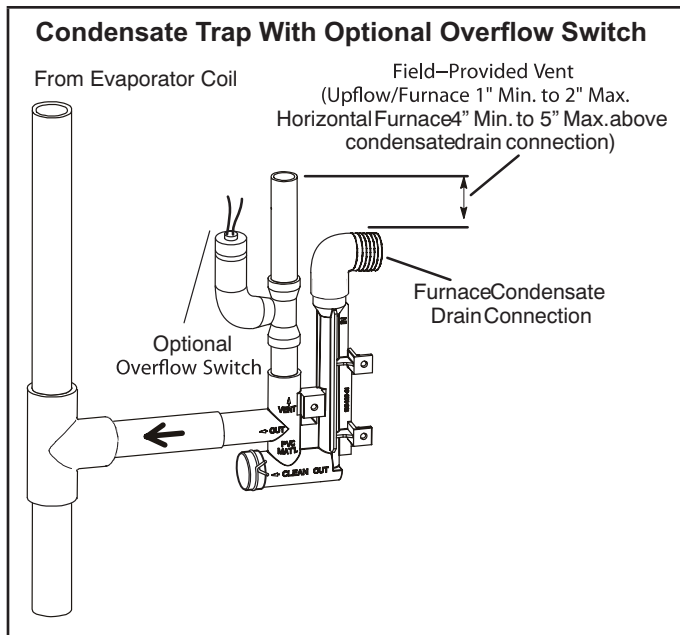

FIGURE 47

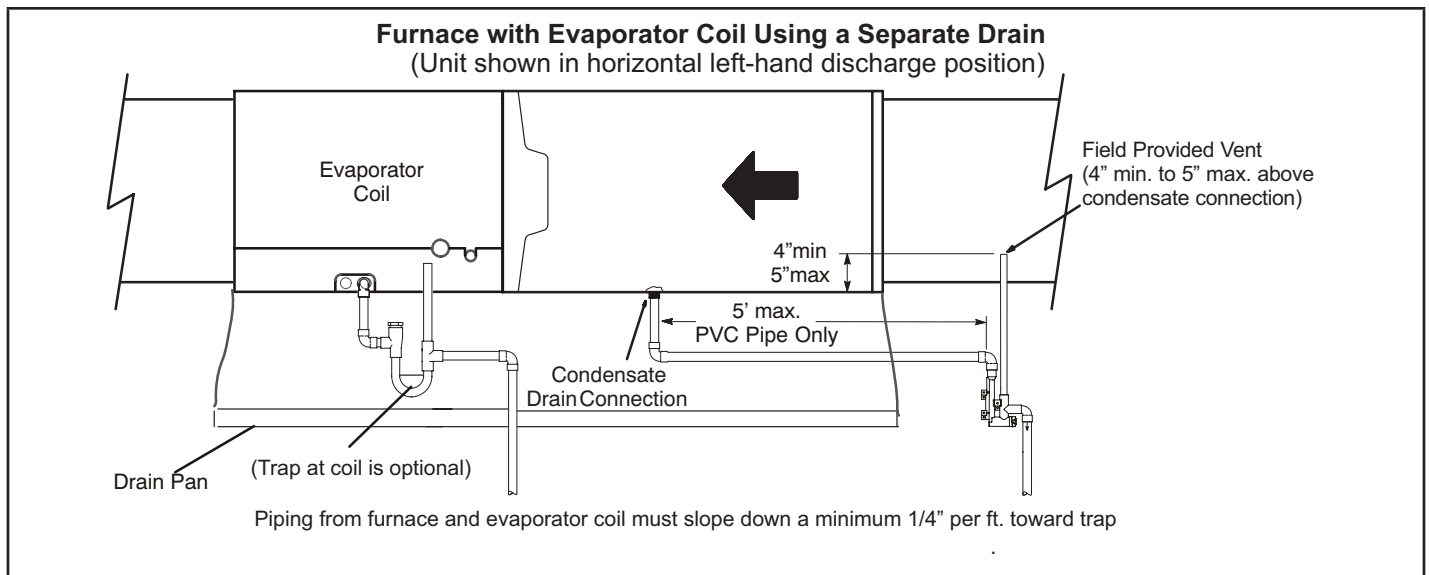

FIGURE 48

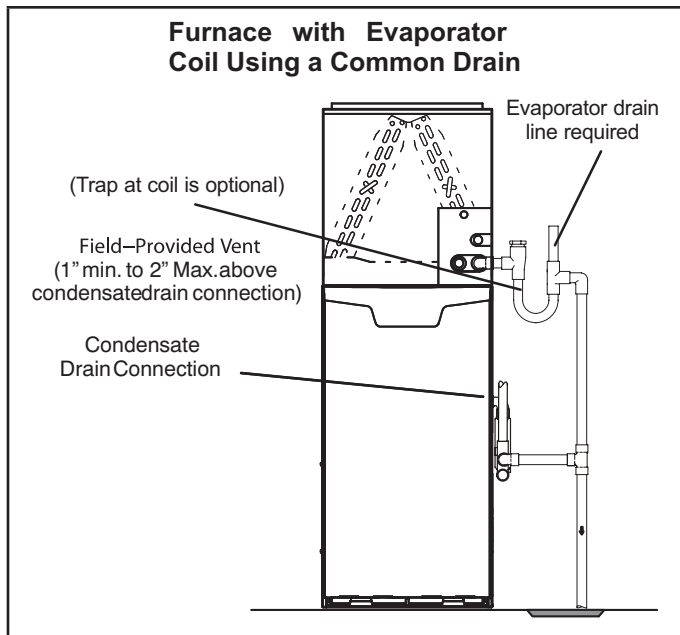

FIGURE 49

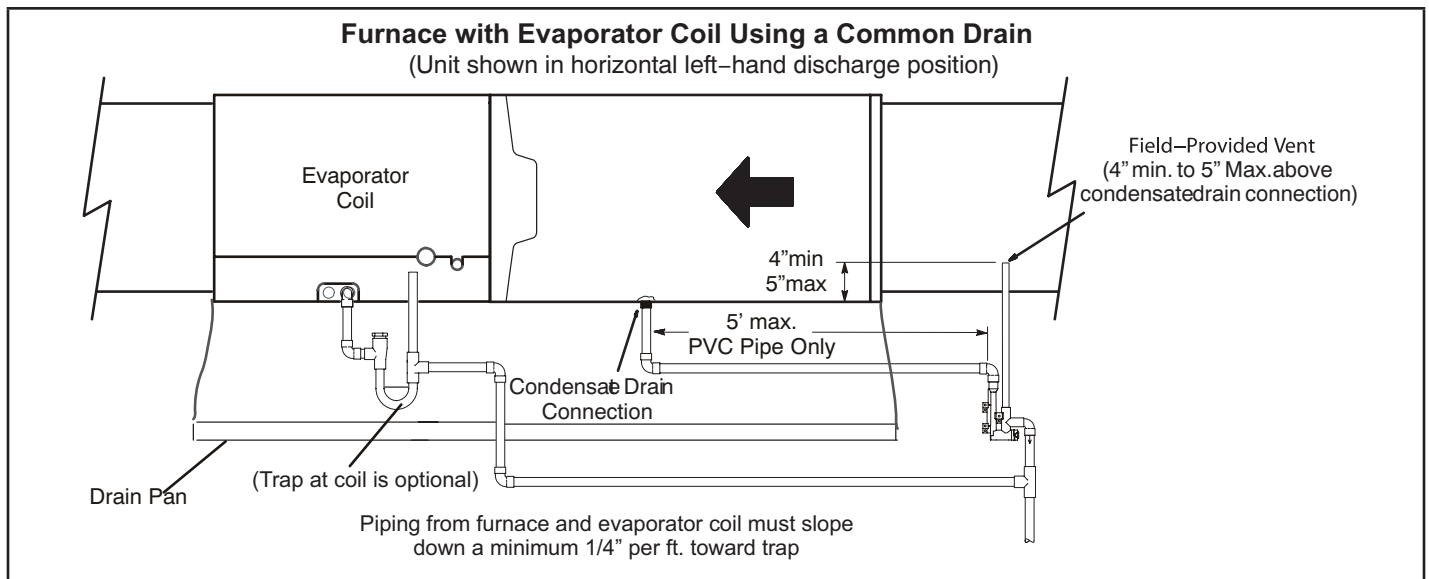
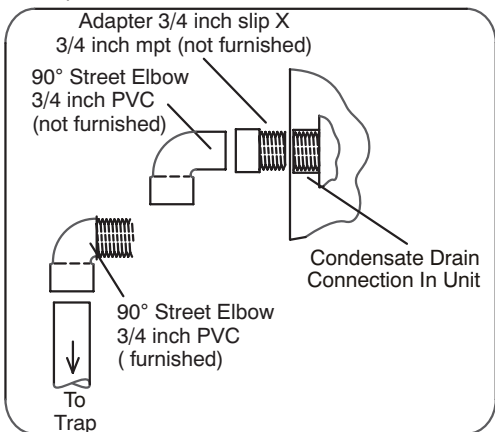

FIGURE 50

TRAP / DRAIN ASSEMBLY USING 1/2" PVC OR 3/4" PVC

Optional Condensate Drain Connection



Optional Drain Piping From Trap

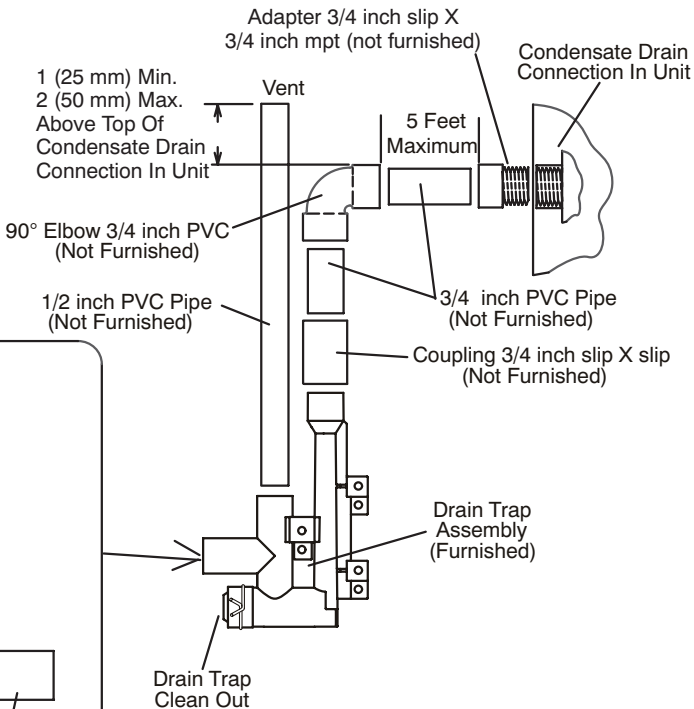
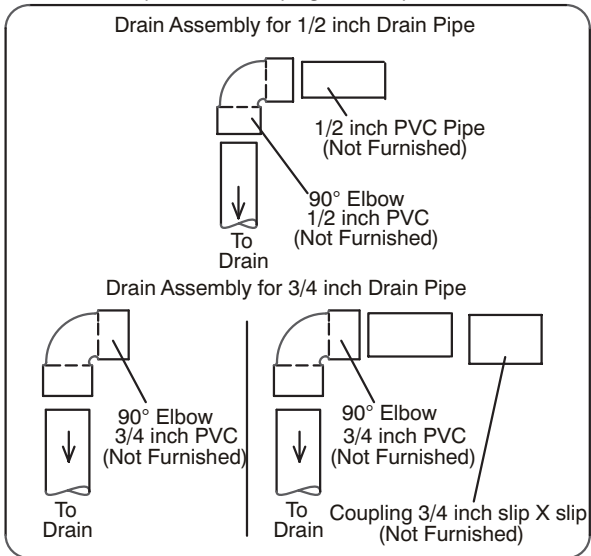

Drain Trap Assembly with 1/2 inch Piping

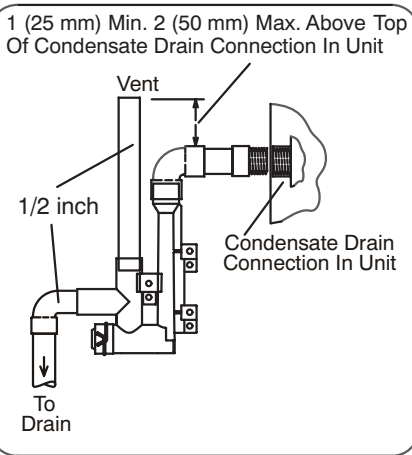

Drain Trap Assembly with 3/4 inch Piping

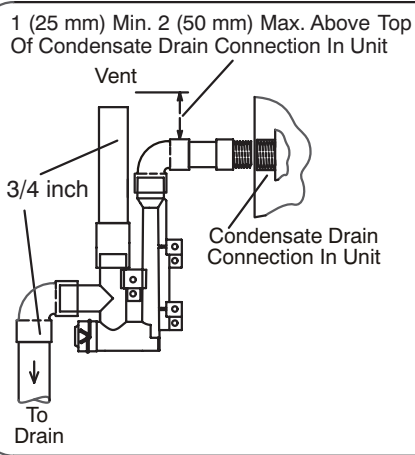

Drain Trap Assembly
(Furnished)

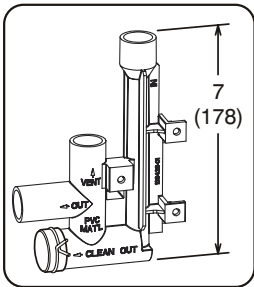

FIGURE 51

III-START-UP

A-Preliminary and Seasonal Checks

- 1 - Inspect electrical wiring, both field and factory installed for loose connections. Tighten as required.
- 2 - Check voltage at disconnect switch. Voltage must be within range listed on the nameplate. If not, consult the power company and have voltage condition corrected before starting unit.
- 3 - Inspect condition of condensate traps and drain assembly. Disassemble and clean seasonally.

B-Heating Start-Up

BEFORE LIGHTING the unit, smell all around the furnace area for gas. Be sure to smell next to the floor because some gas is heavier than air and will settle on the floor. The gas valve on the EL297UHV is equipped with a gas control switch. Use only your hand to move the switch. Never use tools. If the the switch will not move by hand, replace the valve. Do not try to repair it. Force or attempted repair may result in a fire or explosion.

Placing the furnace into operation:

EL297UHV units are equipped with a SureLight® ignition system. Do **not** attempt to manually light burners on this furnace. Each time the thermostat calls for heat, the burners will automatically light. The ignitor does not get hot when there is no call for heat on units with SureLight ignition system.

Priming Condensate Trap

The condensate trap should be primed with water prior to start-up to ensure proper condensate drainage. Either pour 10 fl. oz. (300 ml) of water into the trap, or follow these steps to prime the trap:

- 1 - Follow the lighting instructions to place the unit into operation.
- 2 - Set the thermostat to initiate a heating demand.
- 3 - Allow the burners to fire for approximately 3 minutes.
- 4 - Adjust the thermostat to deactivate the heating demand.
- 5 - Wait for the combustion air inducer to stop. Set the thermostat to initiate a heating demand and again allow the burners to fire for approximately 3 minutes.
- 6 - Adjust the thermostat to deactivate the heating demand and again wait for the combustion air inducer to stop. At this point, the trap should be primed with sufficient water to ensure proper condensate drain operation.

⚠ WARNING

If you do not follow these instructions exactly, a fire or explosion may result causing property damage, personal injury or death.

Gas Valve Operation (FIGURE 52)

- 1 - **STOP!** Read the safety information at the beginning of this section.
- 2 - Set the thermostat to the lowest setting.
- 3 - Turn off all electrical power to the unit.

- 4 - This furnace is equipped with an ignition device which automatically lights the burners. Do not try to light the burners by hand.
- 5 - Remove the upper access panel.
- 6 - Move gas valve switch to **OFF**. See FIGURE 52.
- 7 - Wait five minutes to clear out any gas. If you then smell gas, **STOP!** Immediately call your gas supplier from a neighbor's phone. Follow the gas supplier's instructions. If you do not smell gas go to next step.
- 8 - Move gas valve switch to ON. See FIGURE 52.

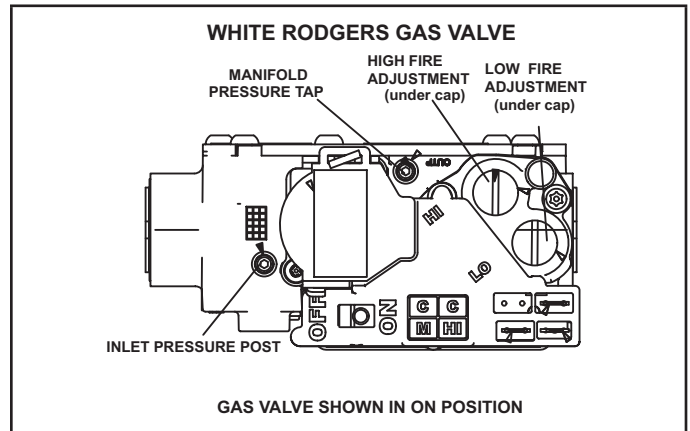

FIGURE 52

- 9 - Replace the upper access panel.
 - 10 - Turn on all electrical power to the unit.
 - 11 - Set the thermostat to desired setting.
- NOTE** - When unit is initially started, steps 1 through 11 may need to be repeated to purge air from gas line.
- 12 - If the appliance will not operate, follow the instructions "Turning Off Gas to Unit" and call your service technician or gas supplier.

Turning Off Gas to Unit

- 1 - Set the thermostat to the lowest setting.
- 2 - Turn off all electrical power to the unit if service is to be performed.
- 3 - Remove the upper access panel.
- 4 - Move gas valve switch to OFF.
- 5 - Replace the upper access panel.

Failure To Operate

If the unit fails to operate, check the following:

- 1 - Is the thermostat calling for heat?
- 2 - Are access panels securely in place?
- 3 - Is the main disconnect switch closed?
- 4 - Is there a blown fuse or tripped breaker?
- 5 - Is the filter dirty or plugged? Dirty or plugged filters will cause the limit control to shut the unit off.
- 6 - Is gas turned on at the meter?
- 7 - Is the manual main shut-off valve open?
- 8 - Is the internal manual shut-off valve open?
- 9 - Is the unit ignition system in lockout? If the unit locks out again, inspect the unit for blockages.

IV-HEATING SYSTEM SERVICE CHECKS

A-CSA Certification

All units are CSA design certified without modifications. Refer to the EL297UHV(X) Installation Instruction.

B-Gas Piping

⚠ CAUTION

If a flexible gas connector is required or allowed by the authority that has jurisdiction, black iron pipe shall be installed at the gas valve and extend outside the furnace cabinet.

⚠ WARNING

Do not over torque (800 in-lbs) or under torque (350 in-lbs) when attaching the gas piping to the gas valve.

Gas supply piping should not allow more than 0.5"W.C. drop in pressure between gas meter and unit. Supply gas pipe must not be smaller than unit gas connection.

Compounds used on gas piping threaded joints should be resistant to action of liquefied petroleum gases.

C-Testing Gas Piping

⚠ IMPORTANT

In case emergency shutdown is required, turn off the main shut-off valve and disconnect the main power to unit. These controls should be properly labeled by the installer.

When pressure testing gas lines, the gas valve must be disconnected and isolated. Gas valves can be damaged if subjected to more than 0.5 psig (14" W.C.). See FIGURE 53. If the pressure is greater than 0.5psig (14"W.C.), use the manual shut-off valve before pressure testing to isolate furnace from gas supply.

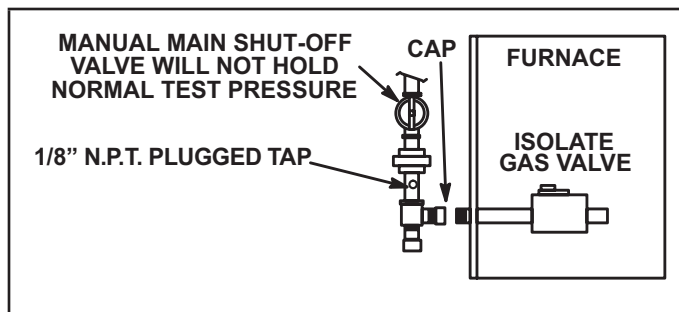

FIGURE 53

When checking piping connections for gas leaks, use preferred means. Kitchen detergents can cause harmful corrosion on various metals used in gas piping. Use of a specialty Gas Leak Detector is strongly recommended. It is available through Lennox under part number 31B2001. See Corp. 8411-L10, for further details.

Do not use matches, candles, flame or any other source of ignition to check for gas leaks.

D-Testing Gas Supply Pressure

An inlet post located on the gas valve provides access to the supply pressure. See FIGURE 52. Back out the 3/32 hex screw one turn, connect a piece of 5/16 tubing and connect to a manometer to measure supply pressure. See TABLE 28 for supply line pressure.

E-Check Manifold Pressure

A manifold pressure post located on the gas valve provides access to the manifold pressure. See FIGURE 52. Back out the 3/32 hex screw one turn, connect a piece of 5/16 tubing and connect to a manometer to measure manifold pressure.

To correctly measure manifold pressure, the differential pressure between the positive gas manifold and the negative burner box must be considered.

⚠ IMPORTANT

For safety, connect a shut-off valve between the manometer and the gas tap to permit shut off of gas pressure to the manometer.

The gas valve is factory set and should not require adjustment. All gas valves are factory regulated.

- 1 - Connect the test gauge positive side "+" to manifold pressure tap on gas valve as noted above.
- 2 - Tee into the gas valve regulator vent hose and connect to test gauge negative "-".
- 3 - Ignite unit on low fire and let run for 5 minutes to allow for steady state conditions.
- 4 - After allowing unit to stabilize for 5 minutes, record manifold pressure and compare to value given in TABLE 28.
- 5 - If necessary, make adjustments. FIGURE 52 shows location of high fire and low fire adjustment screws.
- 6 - Repeat steps 3, 4 and 5 on high fire. See values in TABLE 28.
- 7 - Shut unit off and remove manometer as soon as an accurate reading has been obtained.
- 8 - Start unit and perform leak check. Seal leaks if found.

F- Proper Gas Flow (Approximate)

Furnace should operate at least 5 minutes before checking gas flow. Determine time in seconds for two revolutions of gas through the meter. (Two revolutions assures a more accurate time.) Divide by two and compare to time in TABLE 26. If manifold pressure matches TABLE 26 and rate is incorrect, check gas orifices for proper size and restriction.

NOTE- To obtain accurate reading, shut off all other gas appliances connected to meter.

TABLE 26

GAS METER CLOCKING CHART				
EL297 Unit	Seconds for One Revolution			
	Natural		LP	
	1 cu ft Dial	2 cu ft Dial	1 cu ft Dial	2 cu ft Dial
-045	80	160	200	400
-070	55	110	136	272
-090	41	82	102	204
-110	33	66	82	164
-135	27	54	68	136
Natural-1000 btu/cu ft LP-2500 btu/cu ft				

⚠ IMPORTANT

For safety, shut unit off and remove manometer as soon as an accurate reading has been obtained. Take care to replace pressure tap plug.

G- Proper Combustion

Furnace should operate minimum 15 minutes with correct manifold pressure and gas flow rate before checking combustion. See sections E- and F-. Take combustion sample beyond the flue outlet. TABLE 27 shows acceptable combustions. **The maximum carbon monoxide reading should not exceed 100 ppm.**

TABLE 27

EL297 Model	CO ₂ % For Nat		CO ₂ % For L.P	
	Low Fire	High Fire	Low Fire	High Fire
045	5.4 - 6.4	7.5 - 8.5	6.4 - 7.4	8.8 - 9.8
070	5.3 - 6.3	7.4 - 8.4	6.3 - 7.3	8.7 - 9.7
090	5.8 - 6.8	7.6 - 8.6	6.8 - 7.8	8.9 - 9.9
110	6.1 - 7.1	8.0 - 9.0	7.1 - 8.1	9.3 - 10.3
135	6.1 - 7.1	7.8 - 8.8	7.1 - 8.2	9.1 - 10.1
The maximum carbon monoxide reading should not exceed 100ppm.				

H- High Altitude

The manifold pressure, gas orifice and pressure switch may require adjustment or replacement to ensure proper operation at higher altitudes. See TABLE 28 for manifold pressures. See TABLE 29 for gas conversion and pressure switch kits.

TABLE 28

Manifold and Supply Line Pressure 0-10,000ft.

Unit	Gas	Manifold Pressure in. w.g.										Supply Line Pressure in. w.g 0 - 10,000 ft.	
		0 - 4500 ft		4501 - 5500 ft.		5501 - 6500 ft		6501 - 7500 ft		7501 - 10,000 ft		Min	Max
		Low Fire	High Fire	Low Fire	High Fire	Low Fire	High Fire	Low Fire	High Fire	Low Fire	High Fire		
All Sizes	Natural	1.7	3.5	1.6	3.3	1.5	3.2	1.5	3.1	1.7	3.5	4.5	13.0
	LP/Propane	4.5	10.0	4.2	9.4	4.0	9.1	3.9	8.9	4.5	10.0	11.0	13.0

NOTE - A natural to L.P. propane gas changeover kit is necessary to convert this unit. Refer to the changeover kit installation instruction for the conversion procedure.

TABLE 29

LP/Propane Conversion Kit and Pressure Switch Requirements at Varying Altitudes

Unit	Natural to LP/Propane	High Altitude Natural Burner Orifice Kit	High Altitude LP/Propane Burner Orifice Kit	High Altitude Pressure Switch	
	0 - 7500 ft	7501 - 10,000 ft	7501 - 10,000 ft	4501 - 7500 ft	7501 - 10,000 ft
045	*11K51	73W37	*11K46	14A51	14A53
070				14A48	14A54
090				14A54	14A53
110				25B93	14A45
135				25B94	25B95

*** Conversion requires installation of a gas valve manifold spring which is provided with the gas conversion kit. Pressure switch is factory set. No adjustment necessary. All models use the factory-installed pressure switch from 0-4500 feet (0-1370 m).**

I- Proper Ground and Voltage

A poorly grounded furnace can contribute to premature ignitor failure. Use the following procedure to check for ground and voltage to the integrated control.

- 1 - Measure the AC voltage between Line Neutral (spade terminals) and "C" terminal (low voltage terminal block) on the integrated control. See FIGURE 54. A wide variation in the voltage between Line Neutral and "C" as a function of load indicates a poor or partial ground. Compare the readings to TABLE 30. If the readings exceed the maximum shown in table 1, make repairs before operating the furnace.

NOTE - FIGURE 54 is a typical ignition illustration. Use as reference.

- 2 - In addition, measure the AC voltage from Line Hot to Line Neutral (spade terminals) on the integrated control. See FIGURE 54. This voltage should be in the range of 97 to 132 Vac.

TABLE 30

Furnace Status	Measurement VAC	
	Expected	Maximum
Power On Furnace Idle	0.3	2
CAI / Ignitor Energized	0.75	5
Indoor Blower Energized	Less than 2	10

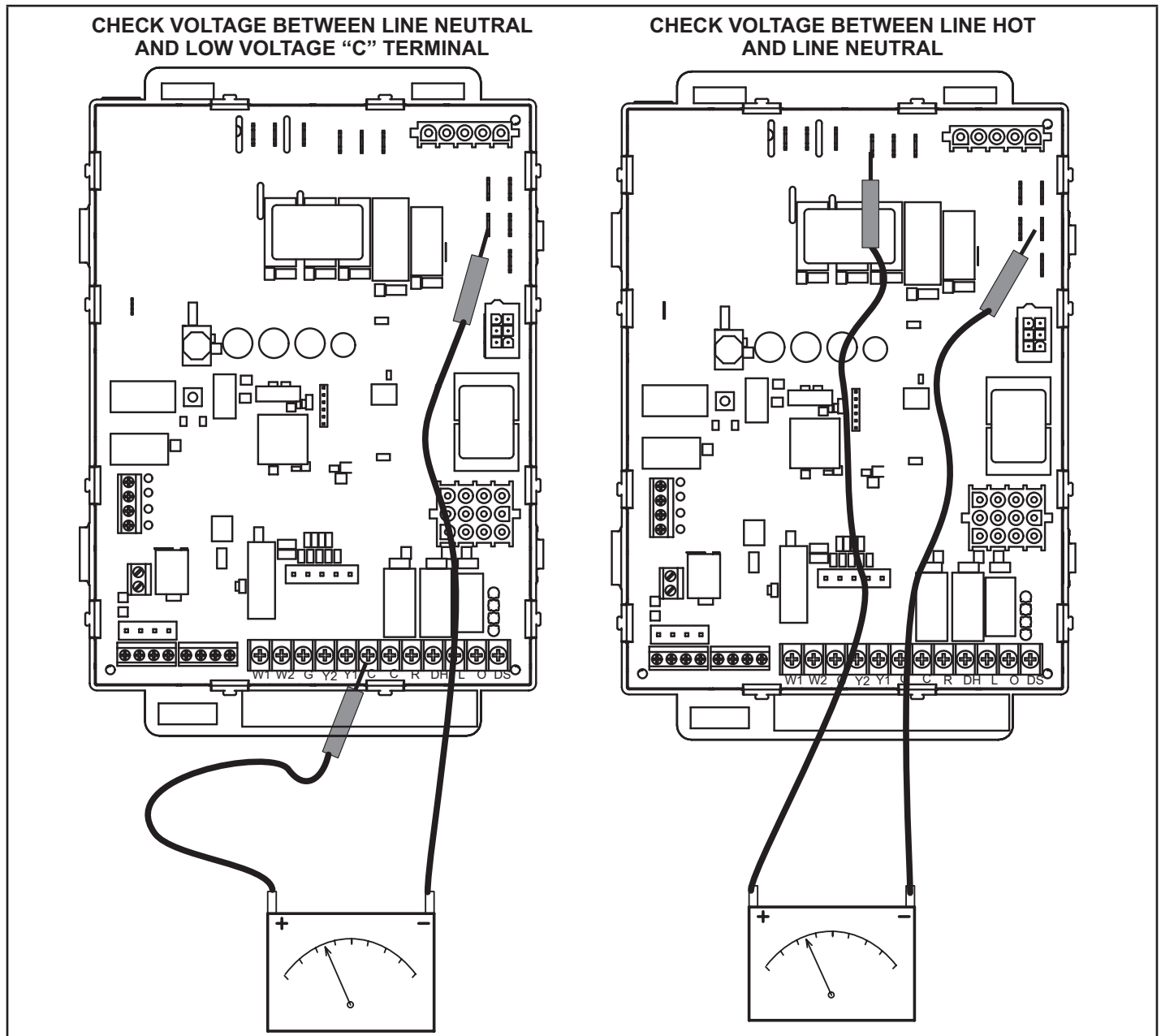

FIGURE 54

V-TYPICAL OPERATING CHARACTERISTICS

A-Blower Operation and Adjustment

- 1 - Blower operation is dependent on thermostat control system.
- 2 - Generally, blower operation is set at thermostat subbase fan switch. With fan switch in ON position, blower operates continuously. With fan switch in AUTO position, blower cycles with demand or runs continuously while heating or cooling circuit cycles.
- 3 - Depending on the type of indoor thermostat, blower and entire unit will be off when the system switch is in OFF position.

B-Temperature Rise (FIGURE 55)

Temperature rise for EL297UHV units depends on unit input, blower speed, blower horsepower and static pressure as marked on the unit rating plate. The blower speed must be set for unit operation within the range of "TEMP. RISE °F" listed on the unit rating plate.

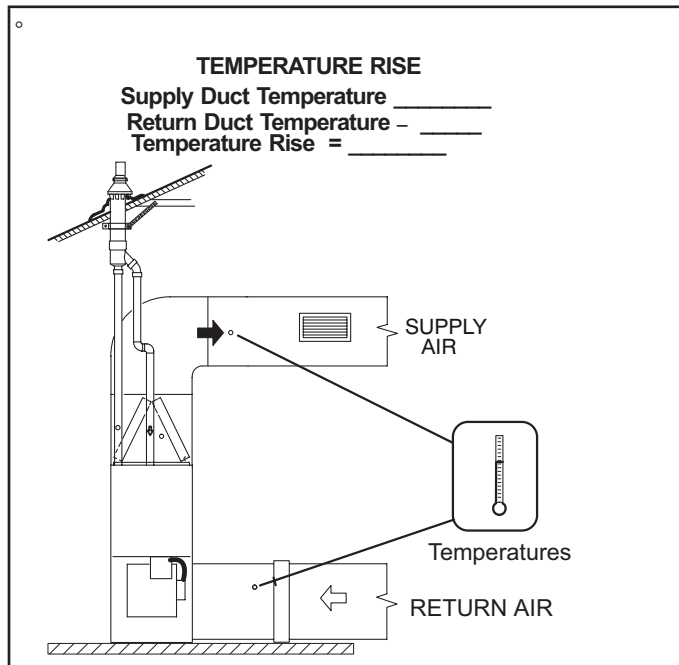

FIGURE 55

C-External Static Pressure

- 1 - Tap locations shown in FIGURE 56.
- 2 - Punch a 1/4" diameter hole in supply and return air plenums. Insert manometer hose flush with inside edge of hole or insulation. Seal around the hose with permagum. Connect the zero end of the manometer to the discharge (supply) side of the system. On ducted systems, connect the other end of manometer to the return duct as above.
- 3 - With only the blower motor running and the evaporator coil dry, observe the manometer reading. Adjust blower motor speed to deliver the air desired according to the job requirements.
- 4 - Seal the hole when the check is complete.

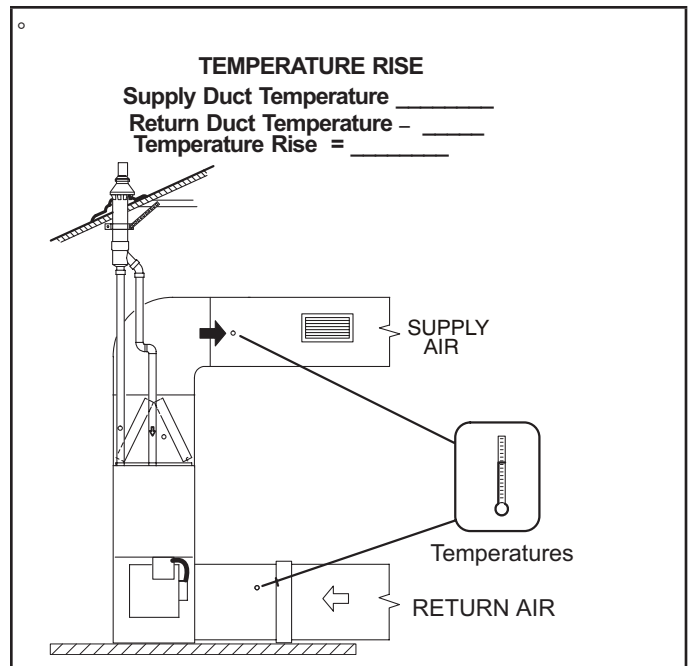

FIGURE 56

VI-MAINTENANCE

⚠ WARNING

**ELECTRICAL SHOCK, FIRE,
OR EXPLOSION HAZARD.**

Failure to follow safety warnings exactly could result in dangerous operation, serious injury, death or property damage.

Improper servicing could result in dangerous operation, serious injury, death, or property damage. Before servicing, disconnect all electrical power to furnace.

When servicing controls, label all wires prior to disconnecting. Take care to reconnect wires correctly. Verify proper operation after servicing.

At the beginning of each heating season, system should be checked as follows by a qualified service technician:

Blower

Check the blower wheel for debris and clean if necessary. The blower motors are prelubricated for extended bearing life. No further lubrication is needed.

⚠ WARNING

The blower access panel must be securely in place when the blower and burners are operating. Gas fumes, which could contain carbon monoxide, can be drawn into living space resulting in personal injury or death.

Filters

All air filters are installed external to the unit. Filters should be inspected monthly. Clean or replace the filters when necessary to ensure proper furnace operation. TABLE 31 lists recommended filter sizes.

⚠ IMPORTANT

If a high efficiency filter is being installed as part of this system to ensure better indoor air quality, the filter must be properly sized. High efficiency filters have a higher static pressure drop than standard efficiency glass/foam filters. If the pressure drop is too great, system capacity and performance may be reduced. The pressure drop may also cause the limit to trip more frequently during the winter and the indoor coil to freeze in the summer, resulting in an increase in the number of service calls.

Before using any filter with this system, check the specifications provided by the filter manufacturer against the data given in the appropriate Lennox Product Specifications bulletin. Additional information is provided in Service and Application Note ACC002 (August 2000).

TABLE 31

Furnace Cabinet Width	Filter Size	
	Side Return	Bottom Return
17-1/2"	16 X 25 X 1 (1)	16 X 25 X 1 (1)
21"	16 X 25 X 1 (1)	20 X 25 X 1 (1)
24-1/2"	16 X 25 X 1 (2)	24 X 25 X 1 (1)

Exhaust and air intake pipes

Check the exhaust and air intake pipes and all connections for tightness and to make sure there is no blockage.

NOTE - After any heavy snow, ice or frozen fog event the furnace vent pipes may become restricted. Always check the vent system and remove any snow or ice that may be obstructing the plastic intake or exhaust pipes.

Electrical

- 1 - Check all wiring for loose connections.
- 2 - Check for the correct voltage at the furnace (furnace operating).
- 3 - Check amp-draw on the blower motor.
Motor Nameplate _____ Actual _____

Winterizing and Condensate Trap Care

- 1 - Turn off power to the furnace.
- 2 - Have a shallow pan ready to empty condensate water.
- 3 - Remove the clean out cap from the condensate trap and empty water. Inspect the trap then reinstall the clean out cap.

Condensate Hose Screens (FIGURE 57)

Check the condensate hose screens for blockage and clean if necessary.

- 1 - Turn off power to the unit.
- 2 - Remove hoses from cold end header box. Twist and pull screens to remove.

- 3 - Inspect screens and rinse with tap water if needed.
- 4 - Reinstall screens, reconnect hoses and turn on power to unit.

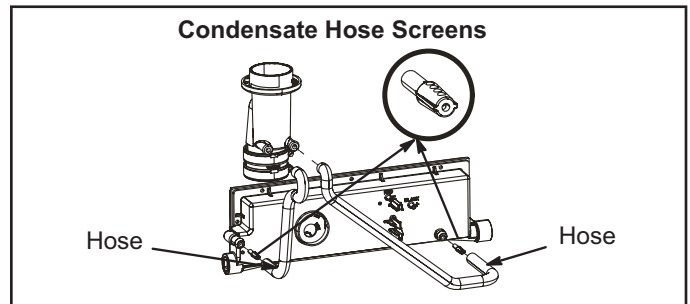

FIGURE 57

Cleaning Heat Exchanger

If cleaning the heat exchanger becomes necessary, follow the below procedures and refer to FIGURE 1 when disassembling unit. Use papers or protective covering in front of furnace while removing heat exchanger assembly.

- 1 - Turn off electrical and gas supplies to the furnace.
- 2 - Remove the furnace access panels.
- 3 - Disconnect the 2 wires from the gas valve.
- 4 - Remove gas supply line connected to gas valve. Remove the burner box cover (if equipped) and remove gas valve/manifold assembly.
- 5 - Remove sensor wire from sensor. Disconnect 2-pin plug from the ignitor.
- 6 - Disconnect wires from flame roll-out switches.
- 7 - Disconnect combustion air intake pipe. It may be necessary to cut the existing pipe to remove burner box assembly.
- 8 - Remove four burner box screws at the vestibule panel and remove burner box. Set burner box assembly aside.
NOTE - If necessary, clean burners at this time. Follow procedures outlined in Burner Cleaning section.
- 9 - Loosen the clamps to the flexible exhaust coupling.
- 10 - Disconnect condensate drain line from the cold end header box.
- 11 - Disconnect condensate drain tubing from flue collar. Remove screws that secures the flue collar into place. Remove flue collar. It may be necessary to cut the exiting exhaust pipe for removal of the fitting.
- 12 - Mark and disconnect all combustion air pressure tubing from cold end header collector box.
- 13 - Mark and remove wires from pressure switch assembly. Remove the assembly. Keep tubing attached to pressure switches.
- 14 - Disconnect the plug from the combustion air inducer. Remove two screws which secure combustion air inducer to collector box. Remove combustion air inducer assembly. Remove ground wire from vest panel.
- 15 - Disconnect the condensate drain line.
- 16 - Remove cold end header box.

- 17 - Remove electrical junction box from the side of the furnace.
- 18 - Mark and disconnect any remaining wiring to heating compartment components. Disengage strain relief bushing and pull wiring and bushing through the hole in the blower deck.
- 19 - Remove the primary limit from the vestibule panel.
- 20 - Remove two screws from the front cabinet flange at the blower deck. Spread cabinet sides slightly to allow clearance for removal of heat exchanger.
- 21 - Remove screws along vestibule sides and bottom which secure vestibule panel and heat exchanger assembly to cabinet. Remove two screws from blower rail which secure bottom heat exchanger flange. Remove heat exchanger from furnace cabinet.
- 22 - Back wash heat exchanger with soapy water solution or steam. ***If steam is used it must be below 275°F (135°C) .***
- 23 - Thoroughly rinse and drain the heat exchanger. Soap solutions can be corrosive. Take care to rinse entire assembly.
- 24 - Reinstall heat exchanger into cabinet making sure that the clamshells of the heat exchanger assembly is engaged properly into the support bracket on the blower deck. Remove the indoor blower to view this area through the blower opening.
- 25 - Re-secure the supporting screws along the vestibule sides and bottom to the cabinet.
- 26 - Reinstall cabinet screws on front flange at blower deck.
- 27 - Reinstall the primary limit on the vestibule panel.
- 28 - Route heating component wiring through hole in blower deck and reinsert strain relief bushing.
- 29 - Reinstall electrical junction box.
- 30 - Reinstall the cold end header box.
- 31 - Reinstall the combustion air inducer. Reconnect the plug to the wire harness.
- 32 - Reinstall pressure switches and reconnect pressure switch wiring.
- 33 - Carefully connect combustion air pressure switch tubing from pressure switches to proper ports on cold end header collector box.
- 34 - Reconnect condensate drain line to the cold end header box.
- 35 - Use securing screws to reinstall flue collar to the top cap on the furnace. Reconnect exhaust piping and exhaust drain tubing.
- 36 - Replace flexible exhaust adapter on combustion air inducer and flue collar. Secure using two existing hose clamps.
- 37 - Reinstall burner box assembly in vestibule area. Secure burner box assembly to vestibule panel using four existing screws. **Make sure burners line up in center of burner ports.**
- 38 - Reconnect flame roll-out switch wires.
- 39 - Reconnect sensor wire and reconnect 2-pin plug from ignitor.
- 40 - Reinstall gas valve manifold assembly. Reconnect gas supply line to gas valve.

- 41 - Reconnect the combustion air intake pipe.
- 42 - Reinstall burner box cover.
- 43 - Reconnect wires to gas valve.
- 44 - Replace the blower compartment access panel.
- 45 - Reconnect gas supply piping. Turn on power and gas supply to unit.
- 46 - Follow lighting instructions on unit nameplate to light and operate furnace for 5 minutes to ensure the furnace is operating properly.
- 47 - Check all piping connections, factory and field, for gas leaks. Use a leak detecting solution or other preferred means.
- 48 - Replace heating compartment access panel.

CAUTION

Some soaps used for leak detection are corrosive to certain metals. Carefully rinse piping thoroughly after leak test has been completed. Do not use matches, candles, flame or other sources of ignition to check for gas leaks.

Cleaning the Burner Assembly (if needed)

- 1 - Turn off electrical and gas power supplies to furnace. Remove upper and lower furnace access panels.
- 2 - Disconnect the wires from the gas valve.
- 3 - Remove the burner box cover (if equipped).
- 4 - Disconnect the gas supply line from the gas valve. Remove gas valve/manifold assembly.
- 5 - Mark and disconnect sensor wire from the sensor. Disconnect wires from flame rollout switches.
- 6 - Disconnect combustion air intake pipe. It may be necessary to cut the existing pipe to remove burner box assembly.
- 7 - Remove four screws which secure burner box assembly to vest panel. Remove burner box from the unit.
- 8 - Use the soft brush attachment on a vacuum cleaner to gently clean the face of the burners. Visually inspect the inside of the burners and crossovers for any blockage caused by foreign matter. Remove any blockage.
- 9 - Reinstall the burner box assembly using the existing four screws. Make sure that the burners line up in the center of the burner ports.
- 10 - Reconnect the sensor wire and reconnect the 2-pin plug to the ignitor wiring harness. Reconnect wires to flame rollout switches.
- 11 - Reinstall the gas valve manifold assembly. Reconnect the gas supply line to the gas valve. Reinstall the burner box cover.
- 12 - Reconnect wires to gas valve.
- 13 - Replace the blower compartment access panel.
- 14 - Refer to instruction on verifying gas and electrical connections when re-establishing supplies.
- 15 - Follow lighting instructions to light and operate furnace for 5 minutes to ensure that heat exchanger is clean and dry and that furnace is operating properly.
- 16 - Replace heating compartment access panel.

EL297UHV-135 WITH IGNITION CONTROL 107045-XX UNIT DIAGRAM

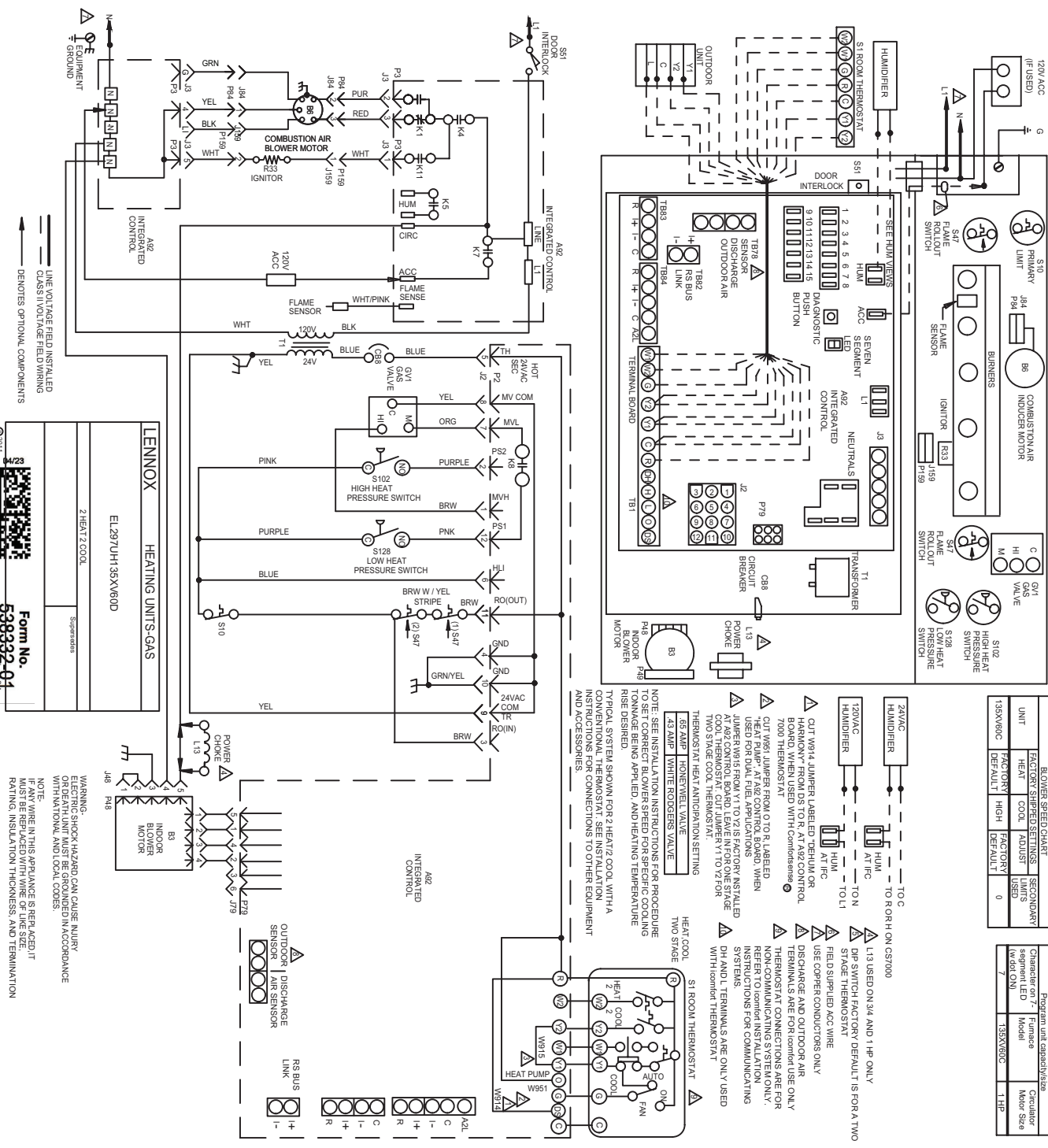

LENNOX HEATING UNITS-GAS

EL297UHV135XV60D

2 HEAT/2 COOL

Supersedes

Form No. 538332-01

Rev. 03/11

WARNING: SHOCK HAZARD CAN CAUSE INJURY OR DEATH. UNIT MUST BE GROUNDED IN ACCORDANCE WITH NATIONAL AND LOCAL CODES.

NOTE: IF ANY WIRE IN THIS APPLIANCE IS REPLACED, IT MUST BE REPLACED WITH WIRE OF THE SAME SIZE, MATERIAL, INSULATION THICKNESS, AND TERMINATION.

BURNER SPEED CHART

UNIT	FACTORY SETPOINT	SECONDARY FACTORY SETTINGS
135XV60C	HEAT	COOL
135XV60C	ADJUST	ADJUST
135XV60C	HIGH	ADJUST
135XV60C	DEFAULT	USED
135XV60C	DEFAULT	0

Program unit capabilities

Character set	Feature	Model	Motor Size
7	Medium	135XV60C	1 HP

Notes:

- 24VAC HAMDRYER: TO R OR H ON C57000
- 135VAC HAMDRYER: AT FIC
- 135VAC HAMDRYER: TON
- 135VAC HAMDRYER: TOL
- CUT W914 JUMPER LABELED "DEHUM OR HARMONY" FROM DS TO R, AT A82 CONTROL BOARD. REFER TO INSTALLATION INSTRUCTIONS FOR COMMUNICATING SYSTEMS.
- USE SUPER CONDUCTORS ONLY.
- DISCHARGE AND OUTDOOR AIR THERMOSTATS ARE FOR OUTDOOR USE ONLY. REFER TO INSTALLATION INSTRUCTIONS FOR COMMUNICATING SYSTEMS.
- DH AND L TERMINALS ARE ONLY USED WITH OUTDOOR THERMOSTAT.
- HEAT/COOL TWO STAGE: HEAT PUMP, FAN, W915, W914.
- HEAT/COOL TWO STAGE: HEAT PUMP, FAN, W915, W914.
- HEAT/COOL TWO STAGE: HEAT PUMP, FAN, W915, W914.

EL297UHV WITH IGNITION CONTROL 107045-XX AND BLOWER DRIVE

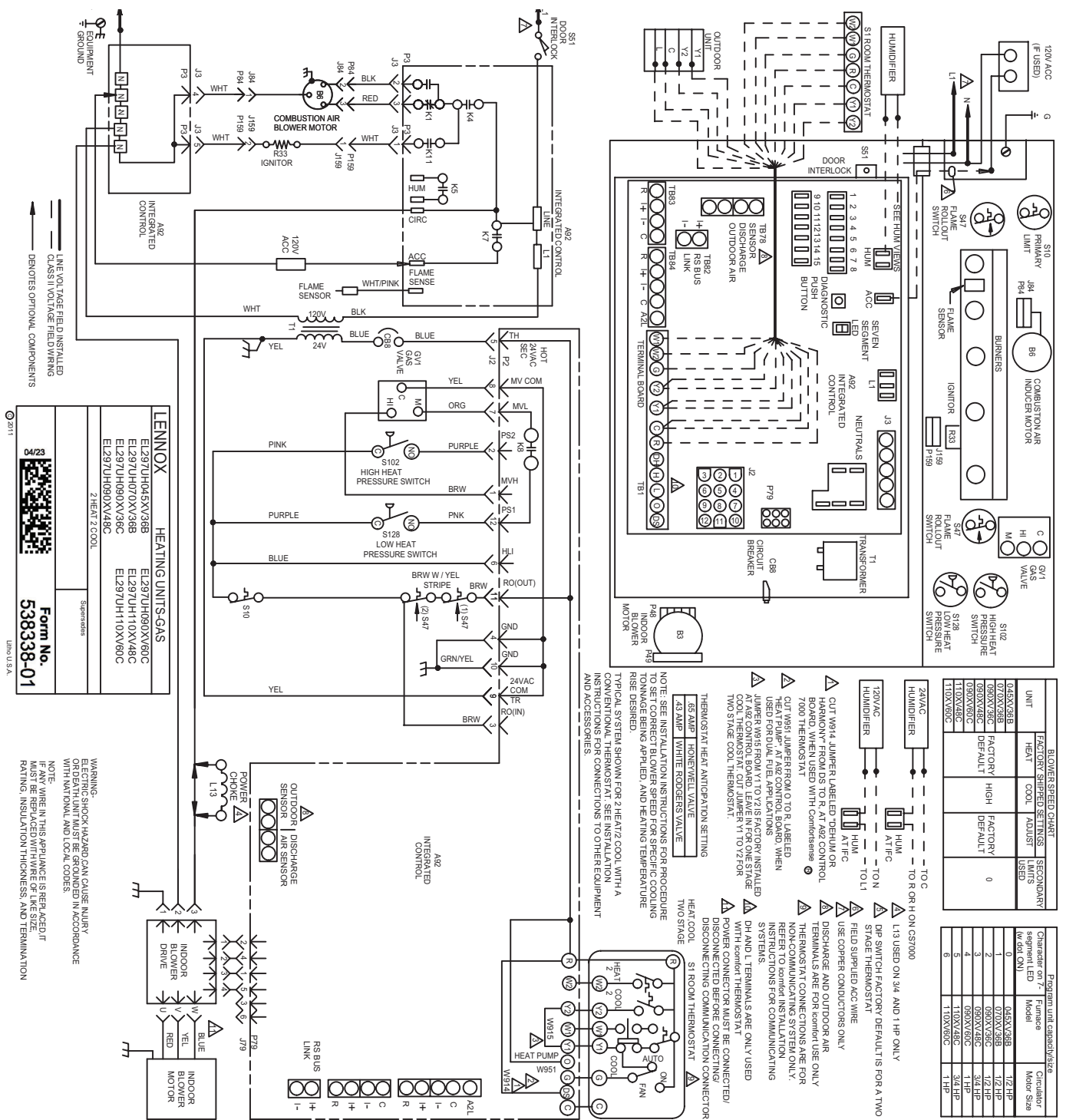

BLOWER SPEED CHART

UNIT	FACTORY SHIPPED SETTINGS	SECONDARY LIMITS
HEAT	COOL	ADJUST
COOL	ADJUST	ADJUST
ADJUST	ADJUST	ADJUST
ADJUST	ADJUST	ADJUST
ADJUST	ADJUST	ADJUST

Program unit capacitization

Character on r- segment LED (w/def ON)	Furnace Model	Circulator Motor Size
0	Q45XV368	1/2 HP
1	Q70XV368	1/2 HP
2	Q80XV368	3/4 HP
3	Q90XV368	1 HP
4	Q60XV46C	3/4 HP
5	T10XV46C	3/4 HP
6	T10XV60C	1 1/4 HP

- NOTE: SEE INSTALLATION INSTRUCTIONS FOR PROCEDURE TO SET CORRECT BLOWER SPEED FOR SPECIFIC COOLING RISES PER HOUR.
- TYPICAL SYSTEMS SHOWN FOR 2 HEAT/2 COOL WITH A COOLING SYSTEM. REFER TO INSTALLATION INSTRUCTIONS FOR CONNECTIONS TO OTHER EQUIPMENT AND ACCESSORIES.
- THERMOSTAT HEAT ANTICIPATION SETTINGS:
 - 43 AMP WHITE ROOFSWEL VALVE
 - 65 AMP WHITE ROOFSWEL VALVE
 - HEAT COOL
 - STAGE
 - DISCONNECTED BEFORE CONNECTING DISCONNECTING COMMUNICATION CONNECTOR
 - POWER CONNECTOR MUST BE CONNECTED WITH Ignition THERMOSTAT
 - AT A2 CONTROL BOARD, LEAVE IN FOR ONE STAGE COOL THERMOSTAT. CUT JUMPER Y1 TO Y2 FOR TWO STAGE COOL THERMOSTAT.
- NOTE: SEE INSTALLATION INSTRUCTIONS FOR PROCEDURE TO SET CORRECT BLOWER SPEED FOR SPECIFIC COOLING RISES PER HOUR.
- TYPICAL SYSTEMS SHOWN FOR 2 HEAT/2 COOL WITH A COOLING SYSTEM. REFER TO INSTALLATION INSTRUCTIONS FOR CONNECTIONS TO OTHER EQUIPMENT AND ACCESSORIES.

LENOX HEATING UNITS-GAS

EL297UH045XV368	EL297UH090XV60C
EL297UH070XV368	EL297UH110XV48C
EL297UH090XV36C	EL297UH110XV60C
EL297UH090XV48C	

2 HEAT 2 COOL

Supersedes

Form No. **538338-01**

04/23

107045-XX

WARNING:
ELECTRIC SHOCK HAZARD CAN CAUSE INJURY OR DEATH. UNIT MUST BE GROUNDING IN ACCORDANCE WITH NATIONAL AND LOCAL CODES.
NOTE: WIRE IN THIS APPLIANCE IS REPLACED IT MUST BE REPLACED WITH WIRE OF LIKE SIZE, RATING, INSULATION THICKNESS AND TERMINATION.

LINE VOLTAGE FIELD INSTALLED
CLASS II VOLTAGE FIELD WIRING
DENOTES OPTIONAL COMPONENTS

EL297UHV WITH IGNITION CONTROL 103130-XX UNIT DIAGRAM

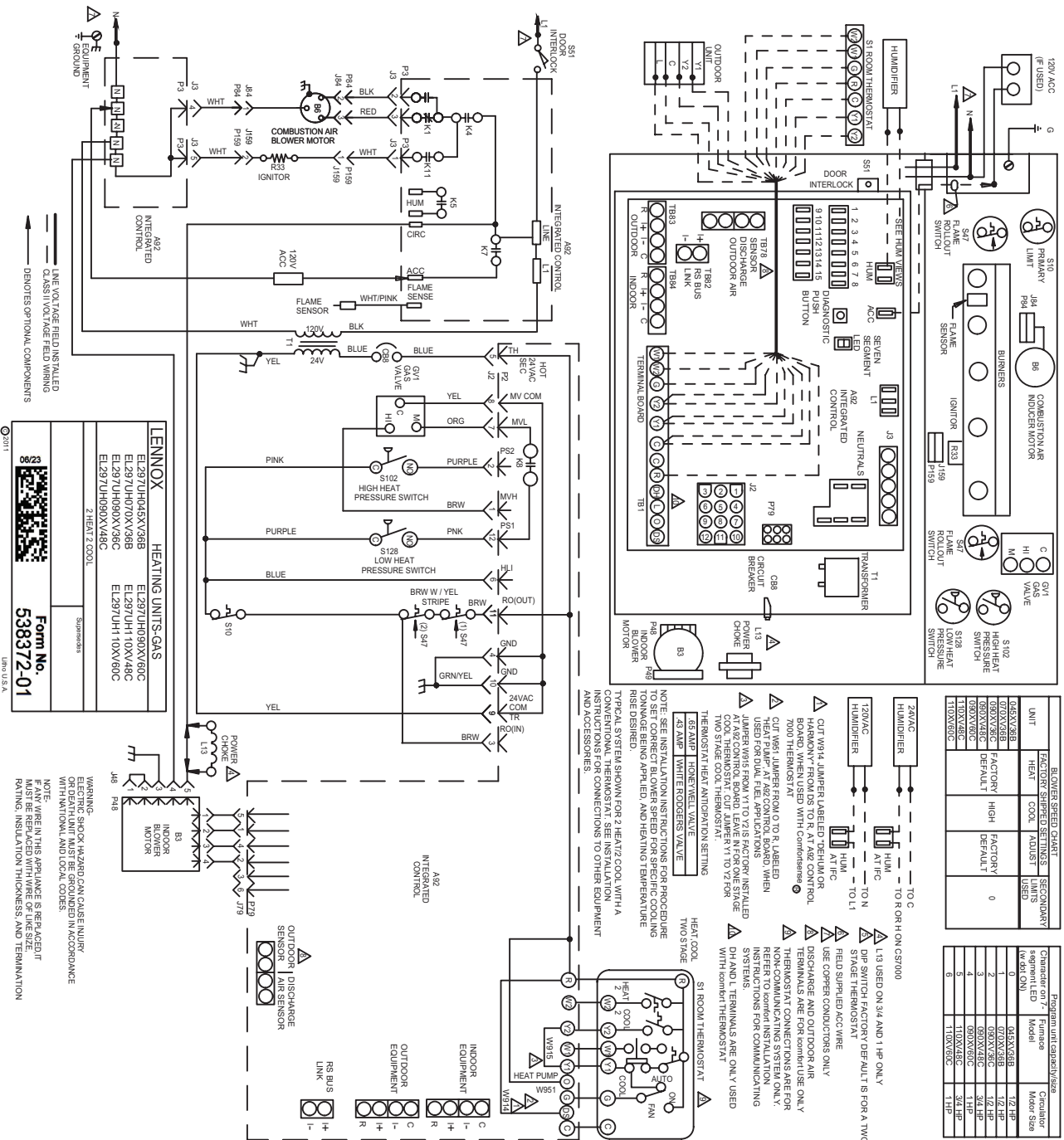

LENOX HEATING UNITS-GAS	
EL297UH045V38B	EL297UH090XV60C
EL297UH070XV38B	EL297UH110XV48C
EL297UH090XV38C	EL297UH110XV60C
EL297UH090XV48C	

Form No. 538372-01

WARNING: BEARING SHORT HEARD GAIN CAUSE INJURY OR DEATH. ALWAYS USE PROPER WIRING TECHNIQUES AND FOLLOW ALL LOCAL AND NATIONAL ELECTRICAL CODES.

NOTE: FAN WIRE IN THIS APPLANCE IS BEING ACCEPTED IF PRINTING INSULATION THICKNESS AND TERMINATION

UNIT	HEAT	COOL	ADJUST	SECONDARY LIMITS USED
EL297UHV38B	FACTORY	COOL	ADJUST	USED
EL297UHV48C	FACTORY	HIGH	DEFAULT	0
EL297UHV60C	FACTORY	DEFAULT	DEFAULT	0

Character on 7" Furnace segment LED Model	Calculator Motor Size	Capacity
W981 (ON)	12 HP	127 MB
W982 (ON)	12 HP	127 MB
W983 (ON)	12 HP	127 MB
W984 (ON)	12 HP	127 MB
W985 (ON)	12 HP	127 MB
W986 (ON)	12 HP	127 MB
W987 (ON)	12 HP	127 MB
W988 (ON)	12 HP	127 MB
W989 (ON)	12 HP	127 MB
W990 (ON)	12 HP	127 MB

EL297UHV-135 WITH IGNITION CONTROL 103130-XX UNIT DIAGRAM

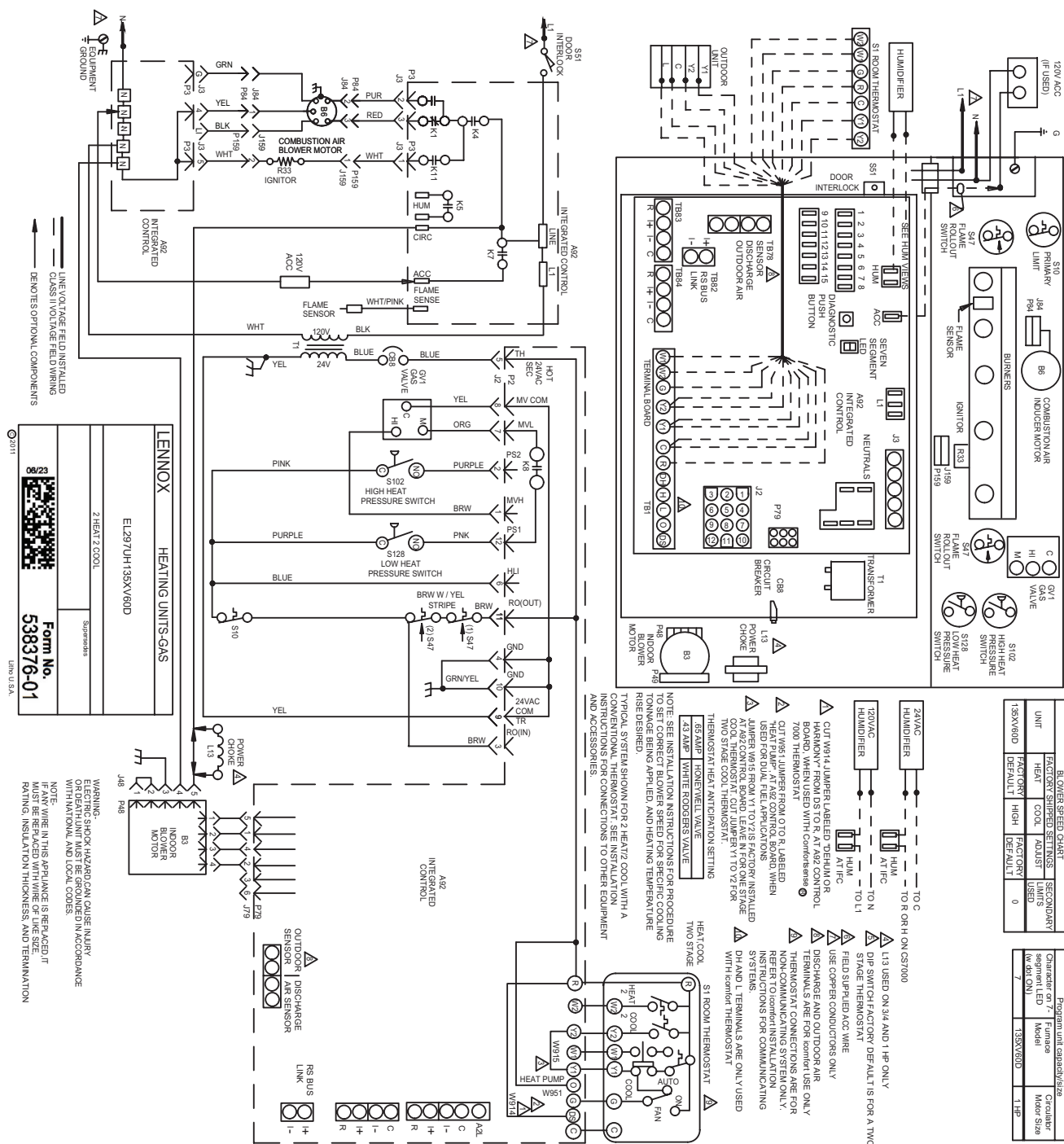

BLOWER SPEED CHART

UNIT	FACTORY SET	ADJUST	SECONDARY LIMITS
HEAT	FACTORY	ADJUST	USED
COOL	FACTORY	ADJUST	USED
135XV60D	DEFAULT	HIGH	DEFAULT
			0

Program and Characteristics

Character on Furnace segment LED (w/ dot ON)	Model	Circular Motor Size
7	135XV60D	1 HP

LENNOX HEATING UNITS-GAS

EL297UHV135XV60D

2 HEAT 2 COOL

Supersedes

Form No. 538376-01

Lennox U.S.A.

WARNING:
ELECTRIC SHOCK HAZARD CAN CAUSE INJURY OR DEATH. UNIT MUST BE GROUNDED IN ACCORDANCE WITH NATIONAL AND LOCAL CODES.
NOTE: WIRE IN THIS APPLIANCE IS BEING Aged. IT MUST BE REPLACED WITH WIRE OF LIKE SIZE, RATING, INSULATION THICKNESS, AND TERMINATION.

- NOTE: SEE INSTALLATION INSTRUCTIONS FOR PROCEEDING TO SET CORRECT BLOWER SPEED FOR SPECIFIC COOLING TONNAGE BEING APPLIED, AND HEATING TEMPERATURE RISE DESIRED.
- TYPICAL SYSTEM SHOWN FOR 2 HEAT/2 COOL WITH A CONVENTIONAL THERMOSTAT. SEE INSTALLATION INSTRUCTIONS FOR WIRE CONNECTIONS TO OTHER EQUIPMENT AND ACCESSORIES.
- HEAT/COOL TWO STAGE
 - L13 USED ON 3/4 AND 1 HP ONLY
 - DIP SWITCH FACTORY DEFAULT IS FOR A TWO STAGE THERMOSTAT
 - FIELD SUPPLIED ACC WIRE
 - USE COPPER CONDUCTORS ONLY
 - DISCHARGE AND OUTDOOR AIR TERMINALS ARE FOR COMFORT USE ONLY. THERMOSTAT CONNECTIONS ARE FOR NON-COMMUNICATING SYSTEM ONLY. INSTRUCTIONS FOR COMMUNICATING SYSTEMS.
 - DH AND L TERMINALS ARE ONLY USED WITH Comfort THERMOSTAT
- HEAT/COOL TWO STAGE
 - 43 AMP LOW VOLTAGE VALVE
 - 65 AMP HONEYWELL VALVE
 - 43 AMP LOW VOLTAGE VALVE
- THERMOSTAT HEAT ANTICIPATION SETTING
- OUT V65 JUMPER FROM OT0 R, LABELED "HARDWON" FROM DS TO R, AT A82 CONTROL BOARD, WHEN USED WITH Comfort 7000 THERMOSTAT
- OUT V65 JUMPER FROM OT0 R, LABELED "HARDWON" FROM DS TO R, AT A82 CONTROL BOARD, WHEN USED WITH Comfort 7000 THERMOSTAT
- USED FOR DUAL FUEL APPLICATIONS
- JUMPER W615 FROM Y1 TO Y2 IS FACTORY INSTALLED AT A82 CONTROL BOARD, LEAVE IN FOR ONE STAGE COOL THERMOSTAT
- USED FOR DUAL FUEL APPLICATIONS
- OUT V65 JUMPER FROM OT0 R, LABELED "HARDWON" FROM DS TO R, AT A82 CONTROL BOARD, WHEN USED WITH Comfort 7000 THERMOSTAT
- USED FOR DUAL FUEL APPLICATIONS
- JUMPER W615 FROM Y1 TO Y2 IS FACTORY INSTALLED AT A82 CONTROL BOARD, LEAVE IN FOR ONE STAGE COOL THERMOSTAT
- USED FOR DUAL FUEL APPLICATIONS

EL297UHV WITH IGNITION CONTROL 103130-XX AND BLOWER DRIVE

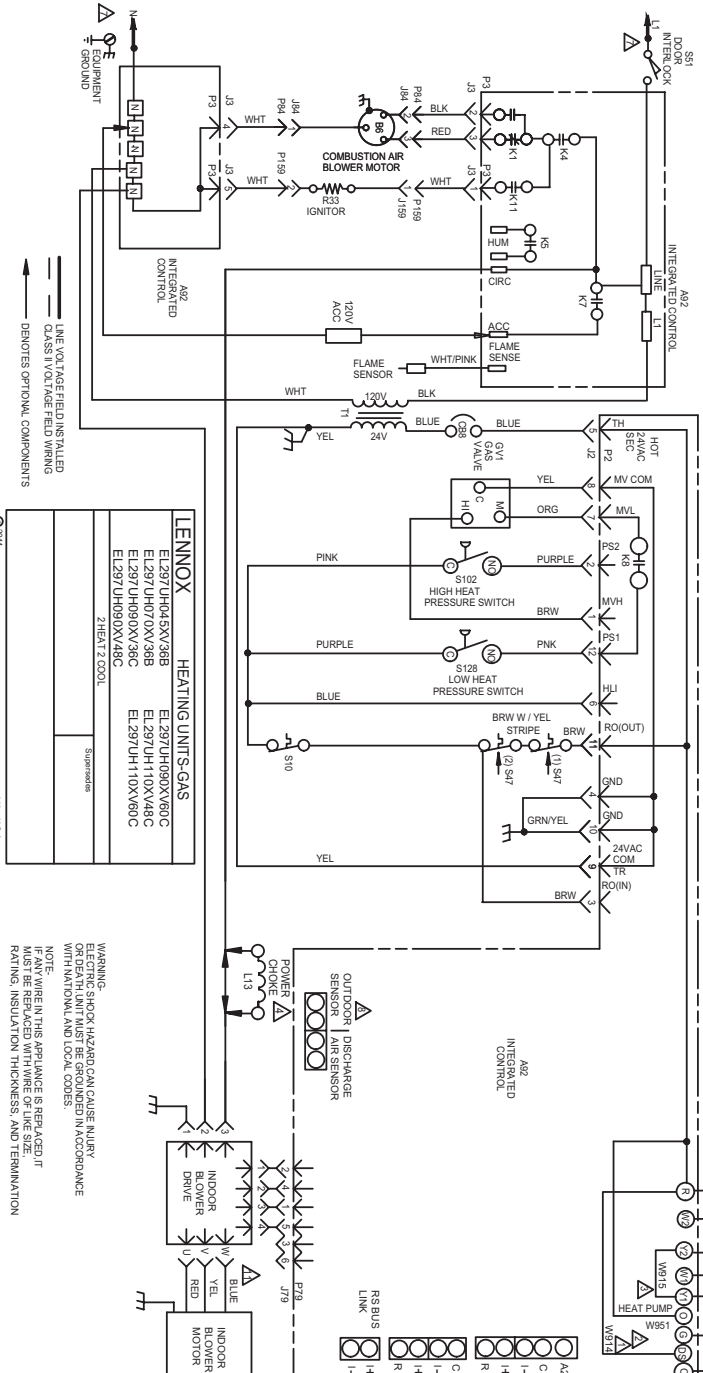

HEATING UNITS-GAS	
EL297JH04SVX/38B	EL297JH090X/96C
EL297JH070X/38B	EL297JH110X/48C
EL297JH090X/38C	EL297JH110X/96C
EL297JH090X/48C	
Z-HEATZ COOL	

WARNING
ELECTRIC SHOCK HAZARD CAN CAUSE INJURY OR DEATH. DISCONNECT POWER TO THE UNIT BEFORE ATTEMPTING ANY WORK.
NOTE: IF ANY WIRE IN THIS APPLIANCE IS REPLACED, IT MUST BE REPLACED WITH WIRE OF THE SAME SIZE, MATERIAL, INSULATION THICKNESS, AND TERMINATION.

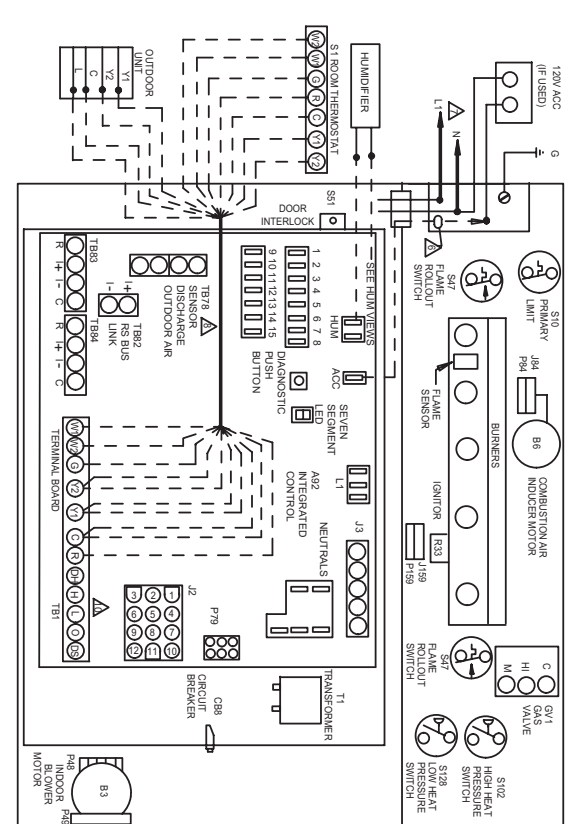

Blower Speed Chart			
UNIT	FACTORY SHIMMED SETTINGS	SECONDARY LIMITS	USED
0	HEAT	COOL	ADJUST
1	HEAT	COOL	ADJUST
2	HEAT	COOL	ADJUST
3	HEAT	COOL	ADJUST
4	HEAT	COOL	ADJUST
5	HEAT	COOL	ADJUST
6	HEAT	COOL	ADJUST

Diagram Unit(s) Label(s)			
Character or Segment LED	Model	Blower Motor Size	Control
0	04SVX/38B	1/2 HP	Control
1	070X/38B	1/2 HP	Control
2	090X/38C	1/2 HP	Control
3	090X/48C	3/4 HP	Control
4	090X/96C	1 HP	Control
5	110X/48C	3/4 HP	Control
6	110X/96C	1 HP	Control

NOTES:
 1. L13 USED ON CS700.
 2. DIP SWITCH FACTORY DEFAULTS FOR A TWO STAGE THERMOSTAT.
 3. FIELD SUPPLIED ACC WIRE.
 4. DISCHARGE AND OUTDOOR AIR THERMOSTAT CONNECTIONS ARE FOR NON-INTERLOCKED SYSTEMS. REFER TO INSTALLATION INSTRUCTIONS FOR COMMUNICATING SYSTEMS.
 5. DH AND L1 TERMINALS ARE ONLY USED FOR REPAIR THERMOSTAT BE CONNECTED/DISCONNECTED BEFORE COMMUNICATION CONNECTOR.
 6. S1 ROOM THERMOSTAT.
 7. HEAT PUMP W/HTL.
 8. HEAT PUMP W/HTL.
 9. HEAT PUMP W/HTL.
 10. HEAT PUMP W/HTL.
 11. HEAT PUMP W/HTL.
 12. HEAT PUMP W/HTL.
 13. HEAT PUMP W/HTL.
 14. HEAT PUMP W/HTL.
 15. HEAT PUMP W/HTL.
 16. HEAT PUMP W/HTL.
 17. HEAT PUMP W/HTL.
 18. HEAT PUMP W/HTL.
 19. HEAT PUMP W/HTL.
 20. HEAT PUMP W/HTL.
 21. HEAT PUMP W/HTL.
 22. HEAT PUMP W/HTL.
 23. HEAT PUMP W/HTL.
 24. HEAT PUMP W/HTL.
 25. HEAT PUMP W/HTL.
 26. HEAT PUMP W/HTL.
 27. HEAT PUMP W/HTL.
 28. HEAT PUMP W/HTL.
 29. HEAT PUMP W/HTL.
 30. HEAT PUMP W/HTL.
 31. HEAT PUMP W/HTL.
 32. HEAT PUMP W/HTL.
 33. HEAT PUMP W/HTL.
 34. HEAT PUMP W/HTL.
 35. HEAT PUMP W/HTL.
 36. HEAT PUMP W/HTL.
 37. HEAT PUMP W/HTL.
 38. HEAT PUMP W/HTL.
 39. HEAT PUMP W/HTL.
 40. HEAT PUMP W/HTL.
 41. HEAT PUMP W/HTL.
 42. HEAT PUMP W/HTL.
 43. HEAT PUMP W/HTL.
 44. HEAT PUMP W/HTL.
 45. HEAT PUMP W/HTL.
 46. HEAT PUMP W/HTL.
 47. HEAT PUMP W/HTL.
 48. HEAT PUMP W/HTL.
 49. HEAT PUMP W/HTL.
 50. HEAT PUMP W/HTL.
 51. HEAT PUMP W/HTL.
 52. HEAT PUMP W/HTL.
 53. HEAT PUMP W/HTL.
 54. HEAT PUMP W/HTL.
 55. HEAT PUMP W/HTL.
 56. HEAT PUMP W/HTL.
 57. HEAT PUMP W/HTL.
 58. HEAT PUMP W/HTL.
 59. HEAT PUMP W/HTL.
 60. HEAT PUMP W/HTL.
 61. HEAT PUMP W/HTL.
 62. HEAT PUMP W/HTL.
 63. HEAT PUMP W/HTL.
 64. HEAT PUMP W/HTL.
 65. HEAT PUMP W/HTL.
 66. HEAT PUMP W/HTL.
 67. HEAT PUMP W/HTL.
 68. HEAT PUMP W/HTL.
 69. HEAT PUMP W/HTL.
 70. HEAT PUMP W/HTL.
 71. HEAT PUMP W/HTL.
 72. HEAT PUMP W/HTL.
 73. HEAT PUMP W/HTL.
 74. HEAT PUMP W/HTL.
 75. HEAT PUMP W/HTL.
 76. HEAT PUMP W/HTL.
 77. HEAT PUMP W/HTL.
 78. HEAT PUMP W/HTL.
 79. HEAT PUMP W/HTL.
 80. HEAT PUMP W/HTL.
 81. HEAT PUMP W/HTL.
 82. HEAT PUMP W/HTL.
 83. HEAT PUMP W/HTL.
 84. HEAT PUMP W/HTL.
 85. HEAT PUMP W/HTL.
 86. HEAT PUMP W/HTL.
 87. HEAT PUMP W/HTL.
 88. HEAT PUMP W/HTL.
 89. HEAT PUMP W/HTL.
 90. HEAT PUMP W/HTL.
 91. HEAT PUMP W/HTL.
 92. HEAT PUMP W/HTL.
 93. HEAT PUMP W/HTL.
 94. HEAT PUMP W/HTL.
 95. HEAT PUMP W/HTL.
 96. HEAT PUMP W/HTL.
 97. HEAT PUMP W/HTL.
 98. HEAT PUMP W/HTL.
 99. HEAT PUMP W/HTL.
 100. HEAT PUMP W/HTL.

EL297UHV-135 WITH IGNITION CONTROL 103130-XX AND BLOWER DRIVE

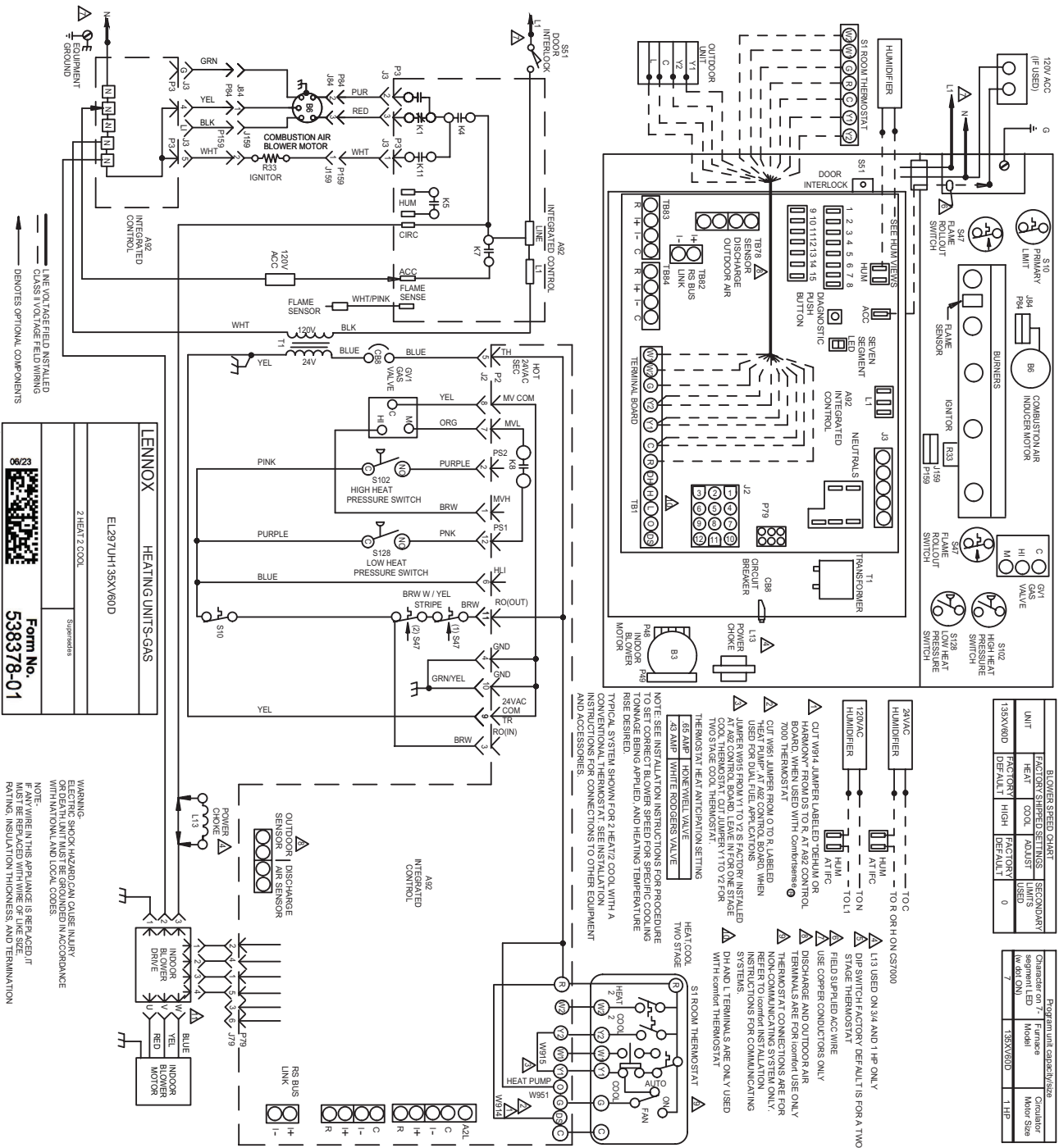

LENNOX HEATING UNITS-GAS
 EL297UHV135XYV60D
 2 HEAT 2 COOL
 Form No. 538378-01
 Labo USA

WARNING:
 ELECTRIC SHOCK HAZARD CAN CAUSE INJURY OR DEATH. THE UNIT MUST BE GROUNDED IN ACCORDANCE WITH THE NATIONAL ELECTRICAL CODE (NEC).
 NOTE:
 IF ANY WIRE IN THIS APPLIANCE IS REPLACED, IT MUST BE REPLACED WITH WIRE OF LIKE SIZE, RATING, INSULATION THICKNESS, AND TERMINATION.

CAUTION

Failure to use properly sized wiring and circuit breaker may result in property damage. Size wiring and circuit breaker(s) per Product Specifications bulletin (EHB) and unit rating plate.

WARNING

Fire Hazard. Use of aluminum wire with this product may result in a fire, causing property damage, severe injury or death. Use copper wire only with this product.

WARNING



Electric Shock Hazard. Can cause injury or death. Unit must be properly grounded in accordance with national and local codes.

Electronic Ignition

The two-stage, variable speed integrated control used in EL297UHV units has an added feature of an internal Watchguard control. The feature serves as an automatic reset device for ignition control lockout caused by ignition failure. After one hour of continuous thermostat demand for heat, the Watchguard will break and remake thermostat demand to the furnace and automatically reset the control to begin the ignition sequence.

NOTE - The ignition control thermostat selection DIP switch is factory-set in the "TWO-STAGE" position.

Applications Using a Two-Stage Thermostat

See FIGURE 58 for ignition control sequence

A - Heating Sequence - Integrated Control Thermostat Selection DIP Switch 1 OFF in "Two-Stage" Position (Factory Setting)

- 1 - On a call for heat, thermostat first-stage contacts close sending a signal to the integrated control. The integrated control runs a self-diagnostic program and checks high temperature limit switches for normally closed contacts and pressure switches for normally open contacts. The combustion air inducer is energized at low speed.
- 2 - Once the control receives a signal that the low pressure switch has closed, the combustion air inducer begins a 15-second pre-purge in low speed.

NOTE - If the low fire pressure switch does not close the combustion air inducer will switch to high fire. After a 15 second pre-purge the high fire pressure switch will close and the unit will begin operation on high fire. After 10 to 20 seconds of high fire operation the unit will switch to low fire.

- 3 - After the pre-purge is complete, a 20-second initial ignitor warm-up period begins. The combustion air inducer continues to operate at low speed.
- 4 - After the 20-second warm-up period has ended, the gas valve is energized on low fire (first stage) and ignition occurs. At the same time, the control module sends a signal to begin an indoor blower 30-second ON-delay. When the delay ends, the indoor blower motor is energized on the low fire heating speed, the HUM contacts close energizing the humidifier and 120V ACC terminal is energized. The furnace will continue this operation as long as the thermostat has a first-stage heating demand.
- 5 - If second-stage heat is required, the thermostat second-stage heat contacts close and send a signal to the integrated control. The integrated control initiates a 30-second second-stage recognition delay.

NOTE - If the indoor thermostat is set on CONTINUOUS FAN ON mode, the furnace will light on high fire (second-stage) for 60 seconds to improve heat exchanger warm up. After 60 second warm-up period, furnace will switch to low fire (first-stage).

- 6 - At the end of the recognition delay, the integrated control energizes the combustion air inducer at high speed. The control also checks the high fire (second stage) pressure switch to make sure it is closed. The high fire (second stage) gas valve is energized and the indoor blower motor is energized for operation at the high fire heating speed.
- 7 - When the demand for high fire (second stage) heat is satisfied, the combustion air inducer is switched to the low-fire heating speed and the high-fire (second stage) gas valve is de-energized. The low-fire (first stage) gas valve continues operation. The indoor blower motor is switched to the low-fire heating speed.
- 8 - When the thermostat demand for low-fire (first stage) heat is satisfied, the gas valve is de-energized and the field-selected indoor blower off delay begins. The combustion air inducer begins a 5-second post-purge period.
- 9 - When the combustion air post-purge period is complete, the inducer, the HUM contacts as well as the 120V ACC terminals are de-energized. The indoor blower is de-energized at the end of the off delay.

Applications Using A Single-Stage Thermostat See FIGURE 59 for ignition control sequence

B - Heating Sequence -- Integrated Control Thermostat Selection DIP Switch 1 ON in "Single-Stage" Position

NOTE - In these applications, two-stage heat will be initiated by the integrated control if heating demand has not been satisfied after the field adjustable period (7 or 12 minutes).

- 1 - On a call for heat, thermostat first-stage contacts close sending a signal to the integrated control. The integrated control runs a self-diagnostic program and checks high temperature limit switches for normally closed contacts and pressure switches for normally open contacts. The combustion air inducer is energized at low speed
- 2 - Once the control receives a signal that the low pressure switch has closed, the combustion air inducer begins a 15-second pre-purge in low speed.

NOTE - If the low fire pressure switch does not close the combustion air inducer will switch to high fire. After a 15 second pre-purge the high fire pressure switch will close and the unit will begin operation on high fire. After 10 to 20 seconds of high fire operation the unit will switch to low fire.

- 3 - After the pre-purge is complete, a 20-second initial ignitor warm-up period begins. The combustion air inducer continues to operate at low speed.

- 4 - After the 20-second warm-up period has ended, the gas valve is energized on low fire (first stage) and ignition occurs. At the same time, the control module sends a signal to begin an indoor blower 30-second ON-delay. When the delay ends, the indoor blower motor is energized on the low fire heating speed and the HUM contacts are energized. The integrated control also initiates a second-stage on delay (factory-set at 7 minutes; adjustable to 12 minutes).
- 5 - If the heating demand continues beyond the second stage on delay, the integrated control energizes the combustion air inducer at high speed. The control also checks the high fire (second stage) pressure switch to make sure it is closed. The high fire (second stage) gas valve is energized and the indoor blower motor is energized for operation at the high fire heating speed.
- 6 - When the thermostat heating demand is satisfied, the combustion air inducer begins a 5-second low speed post-purge. The field-selected indoor blower off delay begins. The indoor blower operates at the low-fire heating speed.
- 7 - When the combustion air post-purge period is complete, the inducer, the HUM contacts as well as the 120V ACC terminals are de-energized. The indoor blower is de-energized at the end of the off delay.

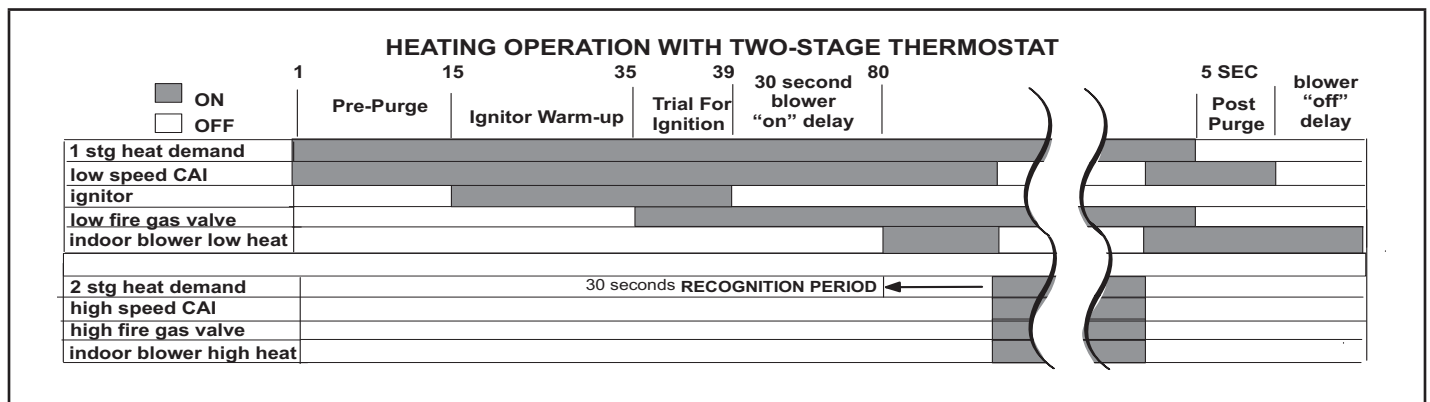

FIGURE 58

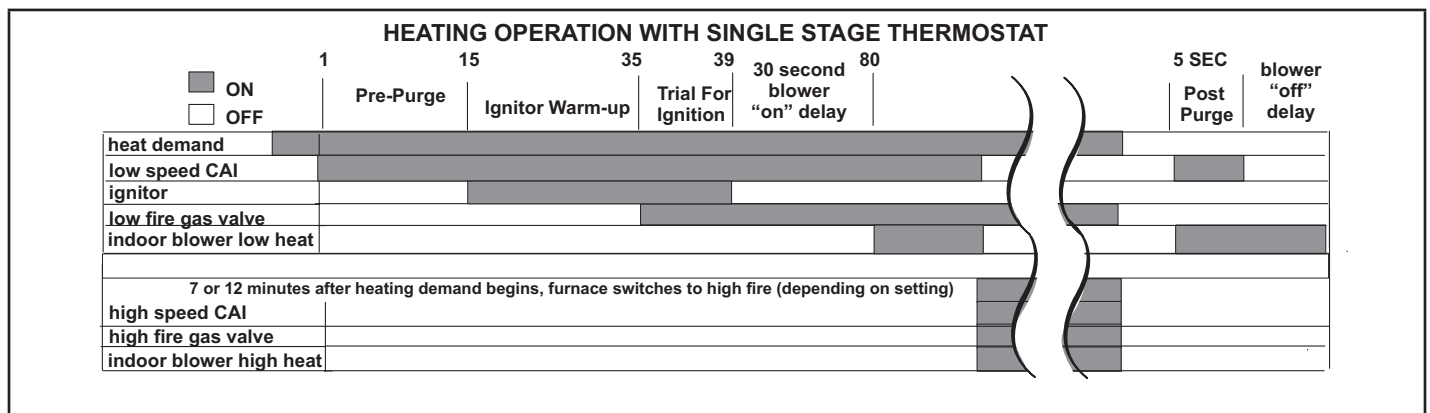
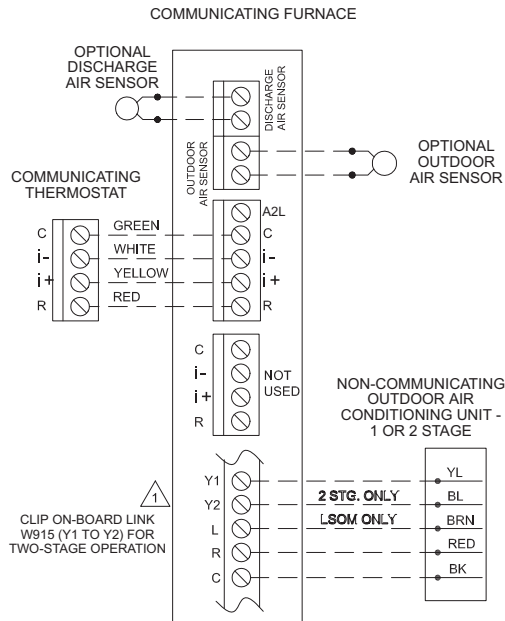

FIGURE 59

VIII- FIELD WIRING WITH CONVENTIONAL AND COMMUNICATING ENABLED THERMOSTAT

Ignition Control Control 107045-XX

Communicating Enabled Furnace and Non-Communicating Outdoor Unit



Communicating Enabled Furnace and Communicating Enabled Outdoor Unit

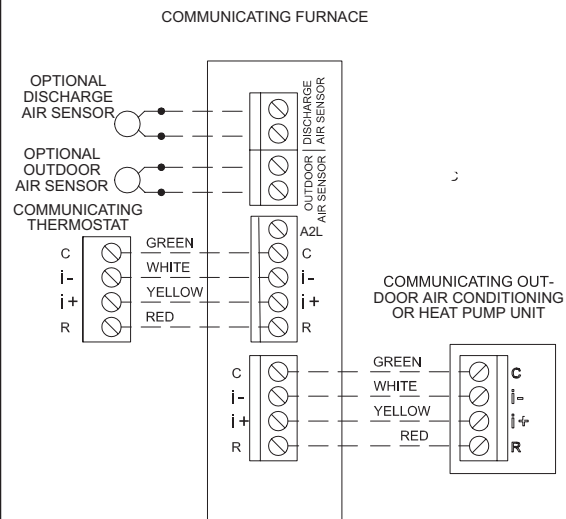

Communicating systems four thermostat wires between the thermostat and the furnace/air handler control and four wires between the outdoor unit and the furnace/air handler control. When a thermostat cable with more than four wires is used, the extra wires must be properly connected to avoid electrical noise. The wires must not be left disconnected.

Use wire nuts to bundle the four unused wires at each end of the cable. A single wire should then be connected to the indoor unit end of the wire bundle and attached to the "C" terminals as shown below.

Outdoor Unit

Communicating Integrated Control

Communicating Thermostat

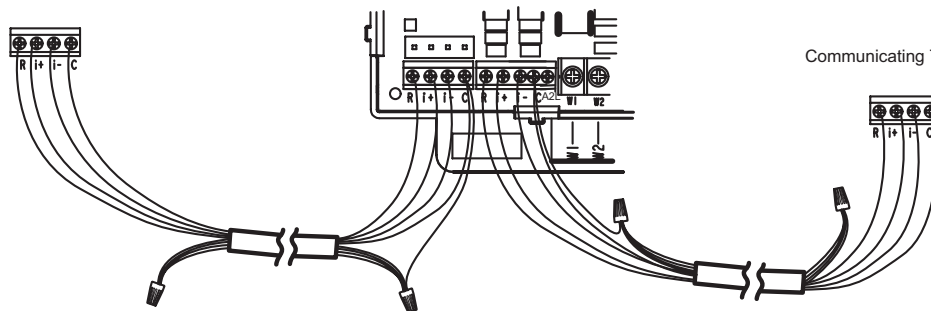

Optional Accessories for use with Communicating System

NOTE: COMMUNICATING THERMOSTAT SENSES HUMIDITY & CONTROLS HUM CONTACTS TO CYCLE HUMIDIFIER BASED ON DEMAND. NO OTHER CONTROL OR HUMIDISTAT REQUIRED.

OPTIONAL OUTDOOR AIR SENSOR FOR USE WITH HUMIDIFIER (IF NOT ALREADY IN THE SYSTEM FOR OTHER FUNCTIONS. BUILT INTO ALL COMMUNICATING ENABLED OUTDOOR UNITS).

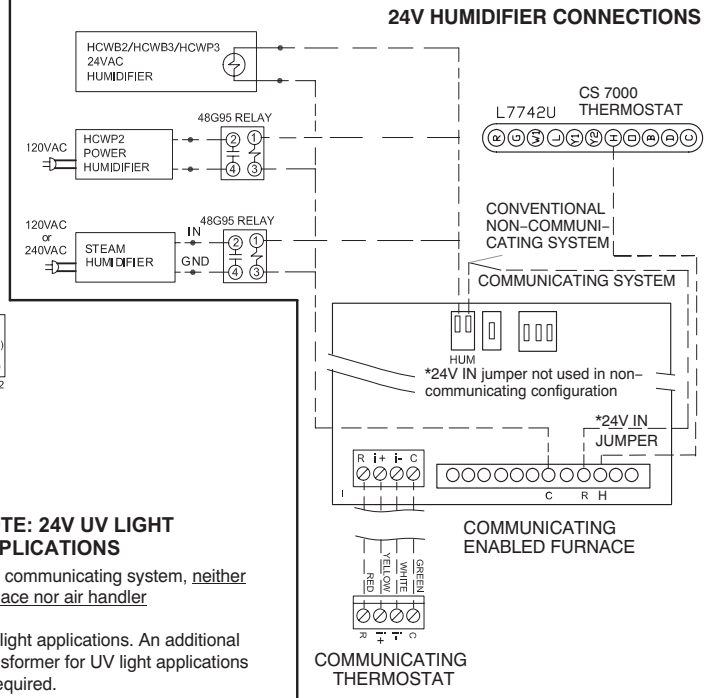
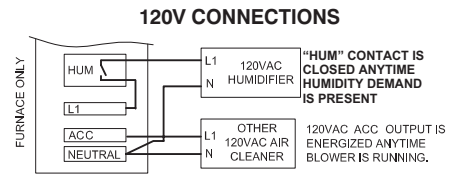
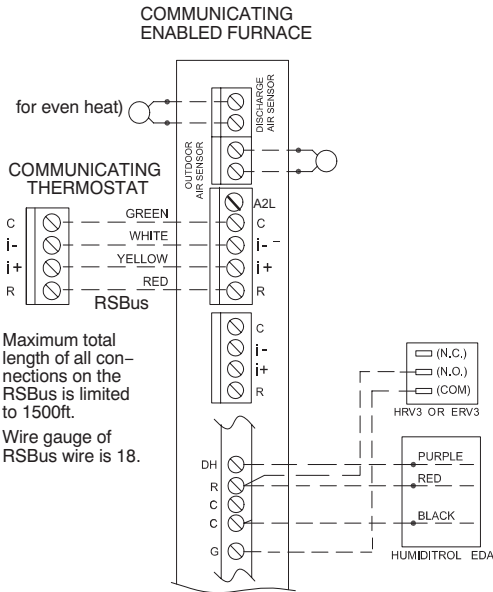

NOTE: 24V UV LIGHT APPLICATIONS
In a communicating system, neither furnace nor air handler
UV light applications. An additional transformer for UV light applications is required.

HEPA BYPASS FILTER X2680 HEPA INTERLOCK KIT

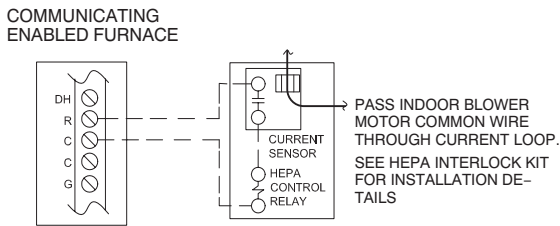

LVCS VENTILATION CONTROL SYSTEM

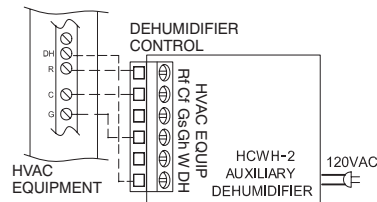
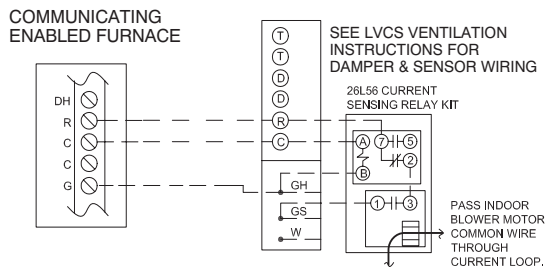

Optional Accessories For Use With Communicating System

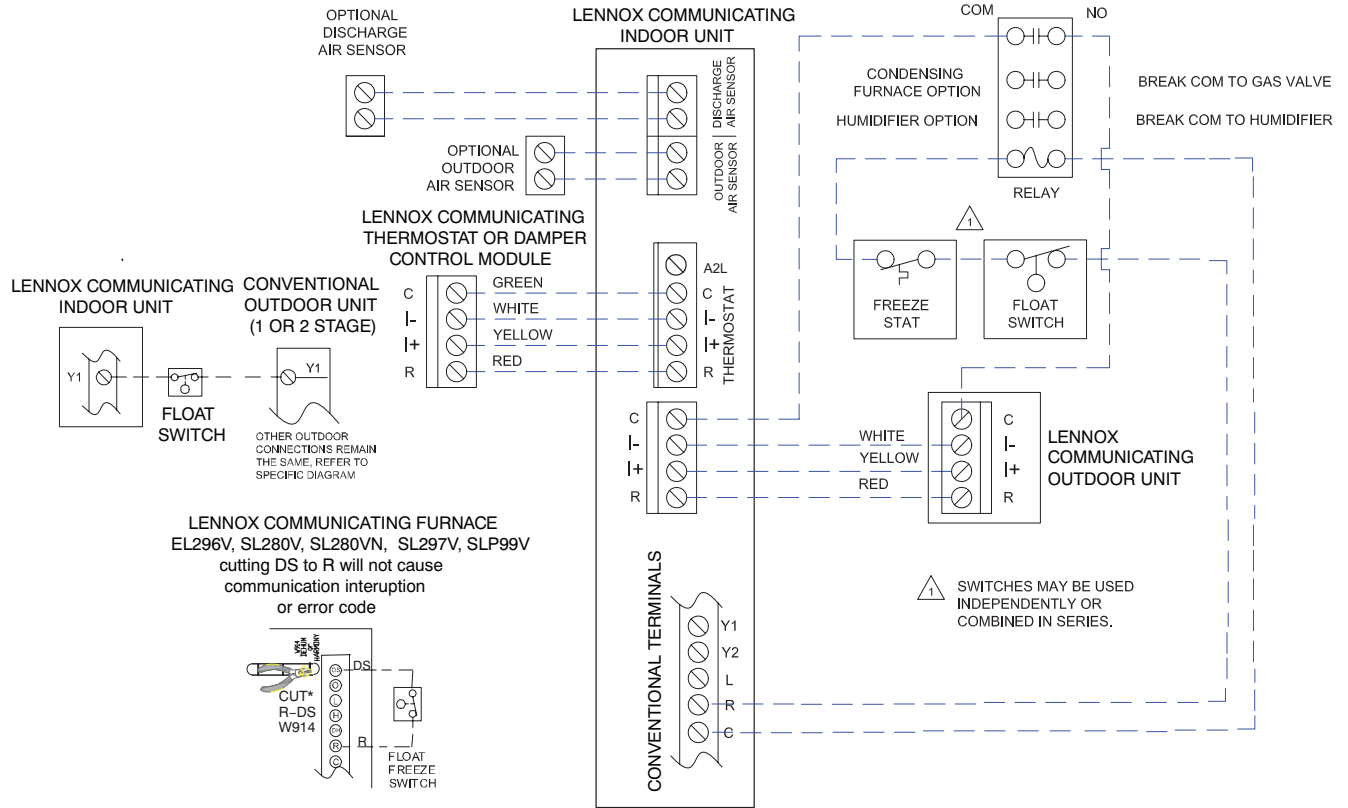

Ignition Control Control 107045-XX DIP Switch Settings and On Board Links

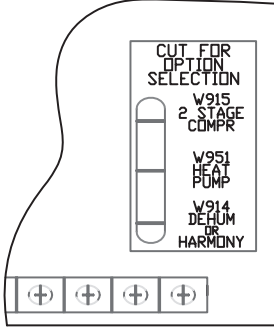
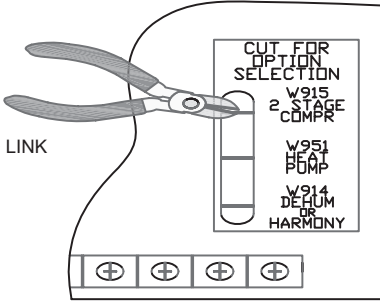
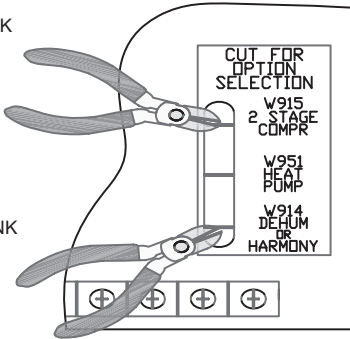
Thermostat	DIP Switch Settings and On-Board Links		Wiring Connections																																	
	DIP Switch 1 Thermostat Heating Stages	On Board Links Must Be Cut To Select System Options																																		
1 Heat / 1 Cool <i>NOTE - Use DIP switch 2 to set second-stage heat ON delay. OFF-7 minutes. ON-12 minutes.</i>	ON	DO NOT CUT ANY ON-BOARD LINKS 	<table border="0"> <tr> <td>S1 T'STAT</td> <td>FURNACE TERM. STRIP</td> <td>OUTDOOR UNIT</td> </tr> <tr> <td></td> <td>(DS)</td> <td></td> </tr> <tr> <td></td> <td>(H)</td> <td></td> </tr> <tr> <td>(W2)</td> <td>(W2)</td> <td></td> </tr> <tr> <td>(W1)-----</td> <td>(W1)</td> <td></td> </tr> <tr> <td>(R)-----</td> <td>(R)</td> <td>*----- (R)</td> </tr> <tr> <td>(G)-----</td> <td>(G)</td> <td></td> </tr> <tr> <td>(C)-----</td> <td>(C)</td> <td>----- (C)</td> </tr> <tr> <td></td> <td>(Y2)</td> <td></td> </tr> <tr> <td>(Y)-----</td> <td>(Y1)</td> <td>----- (Y1)</td> </tr> <tr> <td></td> <td>(O)</td> <td></td> </tr> </table>	S1 T'STAT	FURNACE TERM. STRIP	OUTDOOR UNIT		(DS)			(H)		(W2)	(W2)		(W1)-----	(W1)		(R)-----	(R)	*----- (R)	(G)-----	(G)		(C)-----	(C)	----- (C)		(Y2)		(Y)-----	(Y1)	----- (Y1)		(O)	
S1 T'STAT	FURNACE TERM. STRIP	OUTDOOR UNIT																																		
	(DS)																																			
	(H)																																			
(W2)	(W2)																																			
(W1)-----	(W1)																																			
(R)-----	(R)	*----- (R)																																		
(G)-----	(G)																																			
(C)-----	(C)	----- (C)																																		
	(Y2)																																			
(Y)-----	(Y1)	----- (Y1)																																		
	(O)																																			
1 Heat / 2 Cool <i>NOTE - Use DIP switch 2 to set second-stage heat ON delay. OFF-7 minutes. ON-12 minutes.</i>	ON	CUT ON-BOARD LINK W915 2 STAGE COMPR 	<table border="0"> <tr> <td>S1 T'STAT</td> <td>FURNACE TERM. STRIP</td> <td>OUTDOOR UNIT</td> </tr> <tr> <td></td> <td>(DS)</td> <td></td> </tr> <tr> <td></td> <td>(H)</td> <td></td> </tr> <tr> <td></td> <td>(W2)</td> <td></td> </tr> <tr> <td>(W)-----</td> <td>(W1)</td> <td></td> </tr> <tr> <td>(R)-----</td> <td>(R)</td> <td>*----- (R)</td> </tr> <tr> <td>(G)-----</td> <td>(G)</td> <td></td> </tr> <tr> <td>(C)-----</td> <td>(C)</td> <td>----- (C)</td> </tr> <tr> <td>(Y2)-----</td> <td>(Y2)</td> <td>----- (Y2)</td> </tr> <tr> <td>(Y1)-----</td> <td>(Y1)</td> <td>----- (Y1)</td> </tr> <tr> <td></td> <td>(O)</td> <td></td> </tr> </table>	S1 T'STAT	FURNACE TERM. STRIP	OUTDOOR UNIT		(DS)			(H)			(W2)		(W)-----	(W1)		(R)-----	(R)	*----- (R)	(G)-----	(G)		(C)-----	(C)	----- (C)	(Y2)-----	(Y2)	----- (Y2)	(Y1)-----	(Y1)	----- (Y1)		(O)	
S1 T'STAT	FURNACE TERM. STRIP	OUTDOOR UNIT																																		
	(DS)																																			
	(H)																																			
	(W2)																																			
(W)-----	(W1)																																			
(R)-----	(R)	*----- (R)																																		
(G)-----	(G)																																			
(C)-----	(C)	----- (C)																																		
(Y2)-----	(Y2)	----- (Y2)																																		
(Y1)-----	(Y1)	----- (Y1)																																		
	(O)																																			
1 Heat / 2 Cool with t'stat with humidity control <i>NOTE - Use DIP switch 2 to set second-stage heat ON delay. OFF-7 minutes. ON-12 minutes.</i>	ON	CUT ON-BOARD LINK W915 2 STAGE COMPR CUT ON-BOARD LINK W914 DEHUM OR HARMONY 	<table border="0"> <tr> <td>S1 T'STAT</td> <td>FURNACE TERM. STRIP</td> <td>OUTDOOR UNIT</td> </tr> <tr> <td>(DS)-----</td> <td>(DS)</td> <td></td> </tr> <tr> <td></td> <td>(H)</td> <td></td> </tr> <tr> <td></td> <td>(W2)</td> <td></td> </tr> <tr> <td>(W1)-----</td> <td>(W1)</td> <td></td> </tr> <tr> <td>(R)-----</td> <td>(R)</td> <td>*----- (R)</td> </tr> <tr> <td>(G)-----</td> <td>(G)</td> <td></td> </tr> <tr> <td>(C)-----</td> <td>(C)</td> <td>----- (C)</td> </tr> <tr> <td>(Y2)-----</td> <td>(Y2)</td> <td>----- (Y2)</td> </tr> <tr> <td>(Y1)-----</td> <td>(Y1)</td> <td>----- (Y1)</td> </tr> <tr> <td></td> <td>(O)</td> <td></td> </tr> </table>	S1 T'STAT	FURNACE TERM. STRIP	OUTDOOR UNIT	(DS)-----	(DS)			(H)			(W2)		(W1)-----	(W1)		(R)-----	(R)	*----- (R)	(G)-----	(G)		(C)-----	(C)	----- (C)	(Y2)-----	(Y2)	----- (Y2)	(Y1)-----	(Y1)	----- (Y1)		(O)	
S1 T'STAT	FURNACE TERM. STRIP	OUTDOOR UNIT																																		
(DS)-----	(DS)																																			
	(H)																																			
	(W2)																																			
(W1)-----	(W1)																																			
(R)-----	(R)	*----- (R)																																		
(G)-----	(G)																																			
(C)-----	(C)	----- (C)																																		
(Y2)-----	(Y2)	----- (Y2)																																		
(Y1)-----	(Y1)	----- (Y1)																																		
	(O)																																			

* Not required on all units.

Ignition Control 107045-XX Switch Settings and On Board Links

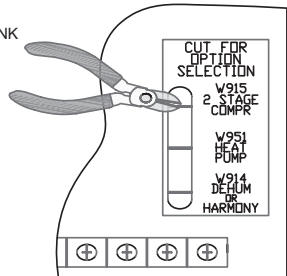
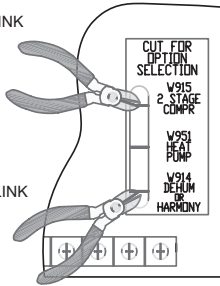
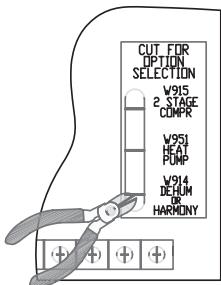
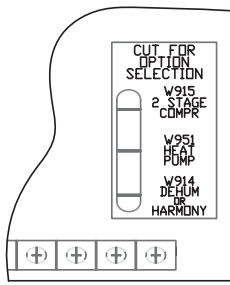
Thermostat	DIP Switch Settings and On-Board Links		Wiring Connections																																	
	DIP Switch 1 Thermostat Heating Stages	On Board Links Must Be Cut To Select System Options																																		
2 Heat / 2 Cool	OFF	<p>CUT ON-BOARD LINK W915 2 STAGE COMPR</p> 	<table border="0"> <tr> <td>S1 T'STAT</td> <td>FURNACE TERM. STRIP</td> <td>OUTDOOR UNIT</td> </tr> <tr> <td>(DS)</td> <td>(DS)</td> <td></td> </tr> <tr> <td></td> <td>(H)</td> <td></td> </tr> <tr> <td>(W2)</td> <td>(W2)</td> <td></td> </tr> <tr> <td>(W1)</td> <td>(W1)</td> <td></td> </tr> <tr> <td>(R)</td> <td>(R) *</td> <td>(R)</td> </tr> <tr> <td>(G)</td> <td>(G)</td> <td></td> </tr> <tr> <td>(C)</td> <td>(C)</td> <td>(C)</td> </tr> <tr> <td>(Y2)</td> <td>(Y2)</td> <td>(Y2)</td> </tr> <tr> <td>(Y1)</td> <td>(Y1)</td> <td>(Y1)</td> </tr> <tr> <td></td> <td>(O)</td> <td></td> </tr> </table>	S1 T'STAT	FURNACE TERM. STRIP	OUTDOOR UNIT	(DS)	(DS)			(H)		(W2)	(W2)		(W1)	(W1)		(R)	(R) *	(R)	(G)	(G)		(C)	(C)	(C)	(Y2)	(Y2)	(Y2)	(Y1)	(Y1)	(Y1)		(O)	
S1 T'STAT	FURNACE TERM. STRIP	OUTDOOR UNIT																																		
(DS)	(DS)																																			
	(H)																																			
(W2)	(W2)																																			
(W1)	(W1)																																			
(R)	(R) *	(R)																																		
(G)	(G)																																			
(C)	(C)	(C)																																		
(Y2)	(Y2)	(Y2)																																		
(Y1)	(Y1)	(Y1)																																		
	(O)																																			
2 Heat / 2 Cool with t'stat with humidity control	OFF	<p>CUT ON-BOARD LINK W915 2 STAGE COMPR</p> <p>CUT ON-BOARD LINK W914 DEHUM OR HARMONY</p> 	<table border="0"> <tr> <td>S1 T'STAT</td> <td>FURNACE TERM. STRIP</td> <td>OUTDOOR UNIT</td> </tr> <tr> <td>(DS)</td> <td>(DS)</td> <td></td> </tr> <tr> <td></td> <td>(H)</td> <td></td> </tr> <tr> <td>(W2)</td> <td>(W2)</td> <td></td> </tr> <tr> <td>(W1)</td> <td>(W1)</td> <td></td> </tr> <tr> <td>(R)</td> <td>(R) *</td> <td>(R)</td> </tr> <tr> <td>(G)</td> <td>(G)</td> <td></td> </tr> <tr> <td>(C)</td> <td>(C)</td> <td>(C)</td> </tr> <tr> <td>(Y2)</td> <td>(Y2)</td> <td>(Y2)</td> </tr> <tr> <td>(Y1)</td> <td>(Y1)</td> <td>(Y1)</td> </tr> <tr> <td></td> <td>(O)</td> <td></td> </tr> </table>	S1 T'STAT	FURNACE TERM. STRIP	OUTDOOR UNIT	(DS)	(DS)			(H)		(W2)	(W2)		(W1)	(W1)		(R)	(R) *	(R)	(G)	(G)		(C)	(C)	(C)	(Y2)	(Y2)	(Y2)	(Y1)	(Y1)	(Y1)		(O)	
S1 T'STAT	FURNACE TERM. STRIP	OUTDOOR UNIT																																		
(DS)	(DS)																																			
	(H)																																			
(W2)	(W2)																																			
(W1)	(W1)																																			
(R)	(R) *	(R)																																		
(G)	(G)																																			
(C)	(C)	(C)																																		
(Y2)	(Y2)	(Y2)																																		
(Y1)	(Y1)	(Y1)																																		
	(O)																																			
2 Heat / 1 Cool with t'stat with humidity control	OFF	<p>CUT ON-BOARD LINK W914 DEHUM OR HARMONY</p> 	<table border="0"> <tr> <td>S1 T'STAT</td> <td>FURNACE TERM. STRIP</td> <td>OUTDOOR UNIT</td> </tr> <tr> <td>(DS)</td> <td>(DS)</td> <td></td> </tr> <tr> <td></td> <td>(H)</td> <td></td> </tr> <tr> <td>(W2)</td> <td>(W2)</td> <td></td> </tr> <tr> <td>(W1)</td> <td>(W1)</td> <td></td> </tr> <tr> <td>(R)</td> <td>(R) *</td> <td>(R)</td> </tr> <tr> <td>(G)</td> <td>(G)</td> <td></td> </tr> <tr> <td>(C)</td> <td>(C)</td> <td>(C)</td> </tr> <tr> <td>(Y1)</td> <td>(Y1)</td> <td>(Y1)</td> </tr> <tr> <td></td> <td>(O)</td> <td></td> </tr> </table>	S1 T'STAT	FURNACE TERM. STRIP	OUTDOOR UNIT	(DS)	(DS)			(H)		(W2)	(W2)		(W1)	(W1)		(R)	(R) *	(R)	(G)	(G)		(C)	(C)	(C)	(Y1)	(Y1)	(Y1)		(O)				
S1 T'STAT	FURNACE TERM. STRIP	OUTDOOR UNIT																																		
(DS)	(DS)																																			
	(H)																																			
(W2)	(W2)																																			
(W1)	(W1)																																			
(R)	(R) *	(R)																																		
(G)	(G)																																			
(C)	(C)	(C)																																		
(Y1)	(Y1)	(Y1)																																		
	(O)																																			
2 Heat / 1 Cool	OFF	<p>DO NOT CUT ANY ON-BOARD LINKS</p> 	<table border="0"> <tr> <td>S1 T'STAT</td> <td>FURNACE TERM. STRIP</td> <td>OUTDOOR UNIT</td> </tr> <tr> <td></td> <td>(DS)</td> <td></td> </tr> <tr> <td></td> <td>(H)</td> <td></td> </tr> <tr> <td>(W2)</td> <td>(W2)</td> <td></td> </tr> <tr> <td>(W1)</td> <td>(W1)</td> <td></td> </tr> <tr> <td>(R)</td> <td>(R) *</td> <td>(R)</td> </tr> <tr> <td>(G)</td> <td>(G)</td> <td></td> </tr> <tr> <td>(C)</td> <td>(C)</td> <td>(C)</td> </tr> <tr> <td></td> <td>(Y2)</td> <td></td> </tr> <tr> <td>(Y)</td> <td>(Y1)</td> <td>(Y1)</td> </tr> <tr> <td></td> <td>(O)</td> <td></td> </tr> </table>	S1 T'STAT	FURNACE TERM. STRIP	OUTDOOR UNIT		(DS)			(H)		(W2)	(W2)		(W1)	(W1)		(R)	(R) *	(R)	(G)	(G)		(C)	(C)	(C)		(Y2)		(Y)	(Y1)	(Y1)		(O)	
S1 T'STAT	FURNACE TERM. STRIP	OUTDOOR UNIT																																		
	(DS)																																			
	(H)																																			
(W2)	(W2)																																			
(W1)	(W1)																																			
(R)	(R) *	(R)																																		
(G)	(G)																																			
(C)	(C)	(C)																																		
	(Y2)																																			
(Y)	(Y1)	(Y1)																																		
	(O)																																			

* Not required on all units.

Ignition Control 107045-XX Switch Settings and On Board Links

Thermostat	DIP Switch Settings and On-Board Links		Wiring Connections																																													
	DIP Switch 1 Thermostat Heating Stages	On Board Links Must Be Cut To Select System Options																																														
Dual Fuel Single Stage Heat Pump ComfortSense thermostat w/ dual fuel capabilities Capable of 2 stage gas heat control	OFF		<table border="0"> <tr> <td>L7742U T'STAT</td> <td>FURNACE TERM. STRIP</td> <td>HEAT PUMP</td> </tr> <tr> <td>(R)-----</td> <td>(R)</td> <td>(R)</td> </tr> <tr> <td>(H)-----</td> <td>(H)</td> <td></td> </tr> <tr> <td>(W2)-----</td> <td>(W2)</td> <td>67M41*</td> </tr> <tr> <td>(W1)-----</td> <td>(W1)</td> <td>(W1)</td> </tr> <tr> <td>(O)-----</td> <td>(O)</td> <td>(O)</td> </tr> <tr> <td>(L)-----</td> <td></td> <td>(L)</td> </tr> <tr> <td>(Y1)-----</td> <td>(Y1)</td> <td>(Y)</td> </tr> <tr> <td>(Y2)-----</td> <td></td> <td>(Y2)</td> </tr> <tr> <td>(G)-----</td> <td>(G)</td> <td></td> </tr> <tr> <td>(D)-----</td> <td>(DS)</td> <td></td> </tr> <tr> <td>(B)-----</td> <td>(Y2)</td> <td></td> </tr> <tr> <td>(C)-----</td> <td>(C)</td> <td>(C)</td> </tr> <tr> <td>(T)-----</td> <td></td> <td>outdoor sensor</td> </tr> <tr> <td>(T)-----</td> <td></td> <td></td> </tr> </table>	L7742U T'STAT	FURNACE TERM. STRIP	HEAT PUMP	(R)-----	(R)	(R)	(H)-----	(H)		(W2)-----	(W2)	67M41*	(W1)-----	(W1)	(W1)	(O)-----	(O)	(O)	(L)-----		(L)	(Y1)-----	(Y1)	(Y)	(Y2)-----		(Y2)	(G)-----	(G)		(D)-----	(DS)		(B)-----	(Y2)		(C)-----	(C)	(C)	(T)-----		outdoor sensor	(T)-----		
L7742U T'STAT	FURNACE TERM. STRIP	HEAT PUMP																																														
(R)-----	(R)	(R)																																														
(H)-----	(H)																																															
(W2)-----	(W2)	67M41*																																														
(W1)-----	(W1)	(W1)																																														
(O)-----	(O)	(O)																																														
(L)-----		(L)																																														
(Y1)-----	(Y1)	(Y)																																														
(Y2)-----		(Y2)																																														
(G)-----	(G)																																															
(D)-----	(DS)																																															
(B)-----	(Y2)																																															
(C)-----	(C)	(C)																																														
(T)-----		outdoor sensor																																														
(T)-----																																																
Dual Fuel Two Stage Heat Pump ComfortSense thermostat w/ dual fuel capabilities Capable of 2 stage gas heat control	OFF		<table border="0"> <tr> <td>L7742U T'STAT</td> <td>FURNACE TERM. STRIP</td> <td>HEAT PUMP</td> </tr> <tr> <td>(R)-----</td> <td>(R)</td> <td>(R)</td> </tr> <tr> <td>(H)-----</td> <td>(H)</td> <td></td> </tr> <tr> <td>(W2)-----</td> <td>(W2)</td> <td>67M41*</td> </tr> <tr> <td>(W1)-----</td> <td>(W1)</td> <td>(W1)</td> </tr> <tr> <td>(O)-----</td> <td>(O)</td> <td>(O)</td> </tr> <tr> <td>(L)-----</td> <td></td> <td>(L)</td> </tr> <tr> <td>(Y1)-----</td> <td>(Y1)</td> <td>(Y1)</td> </tr> <tr> <td>(Y2)-----</td> <td></td> <td>(Y2)</td> </tr> <tr> <td>(G)-----</td> <td>(G)</td> <td></td> </tr> <tr> <td>(D)-----</td> <td>(DS)</td> <td></td> </tr> <tr> <td>(B)-----</td> <td>(Y2)</td> <td>Y2 out blue</td> </tr> <tr> <td>(C)-----</td> <td>(C)</td> <td>(C)</td> </tr> <tr> <td>(T)-----</td> <td></td> <td>outdoor sensor</td> </tr> <tr> <td>(T)-----</td> <td></td> <td></td> </tr> </table>	L7742U T'STAT	FURNACE TERM. STRIP	HEAT PUMP	(R)-----	(R)	(R)	(H)-----	(H)		(W2)-----	(W2)	67M41*	(W1)-----	(W1)	(W1)	(O)-----	(O)	(O)	(L)-----		(L)	(Y1)-----	(Y1)	(Y1)	(Y2)-----		(Y2)	(G)-----	(G)		(D)-----	(DS)		(B)-----	(Y2)	Y2 out blue	(C)-----	(C)	(C)	(T)-----		outdoor sensor	(T)-----		
L7742U T'STAT	FURNACE TERM. STRIP	HEAT PUMP																																														
(R)-----	(R)	(R)																																														
(H)-----	(H)																																															
(W2)-----	(W2)	67M41*																																														
(W1)-----	(W1)	(W1)																																														
(O)-----	(O)	(O)																																														
(L)-----		(L)																																														
(Y1)-----	(Y1)	(Y1)																																														
(Y2)-----		(Y2)																																														
(G)-----	(G)																																															
(D)-----	(DS)																																															
(B)-----	(Y2)	Y2 out blue																																														
(C)-----	(C)	(C)																																														
(T)-----		outdoor sensor																																														
(T)-----																																																

* Connect W1 to W1 ONLY if using defrost tempering kit 67M41

NOTE - **Do NOT** make a wire connection between the room thermostat L terminal and the L terminal of the furnace integrated control.

Ignition Control 107045-XX DIP Switch Settings and On Board Links

Thermostat	DIP Switch Settings and On-Board Links		Wiring Connections
	DIP Switch 1 Thermostat Heating Stages	On Board Links Must Be Cut To Select System Options	
Dual Fuel Single Stage Heat Pump ComfortSense thermostat w/ dual fuel capabilities Capable of 2 stage gas heat control	OFF	<p>CUT ON-BOARD LINK W915 2 STAGE COMPR</p> <p>CUT ON-BOARD LINK W951 HEAT PUMP</p> <p>CUT ON-BOARD LINK W914 DEHUM OR HARMONY</p>	<p>L7742U T'STAT: R, H, W2, W1, O, L, Y1, Y2, G, D, B, C, T, T</p> <p>FURNACE TERM. STRIP: R, H, W2, W1, O, Y1, G, DS, Y2, C</p> <p>HEAT PUMP: R, W1, O, L, Y1, Y2, G, C, outdoor sensor</p> <p>67M41* connects W1 to W1</p>
Dual Fuel Two Stage Heat Pump ComfortSense thermostat w/ dual fuel capabilities Capable of 2 stage gas heat control	OFF	<p>CUT ON-BOARD LINK W915 2 STAGE COMPR</p> <p>CUT ON-BOARD LINK W951 HEAT PUMP</p> <p>CUT ON-BOARD LINK W914 DEHUM OR HARMONY</p>	<p>L7742U T'STAT: R, H, W2, W1, O, L, Y1, Y2, G, D, B, C, T, T</p> <p>FURNACE TERM. STRIP: R, H, W2, W1, O, Y1, G, DS, Y2, C</p> <p>HEAT PUMP: R, W1, O, L, Y1, Y2, G, C, outdoor sensor</p> <p>67M41* connects W1 to W1</p> <p>Y2 out blue</p>

* Connect W1 to W1 ONLY if using defrost tempering kit 67M41

NOTE - **Do NOT** make a wire connection between the room thermostat L terminal and the L terminal of the furnace integrated control.

Communicating Enabled Furnace with a Non-Communicating Outdoor Unit

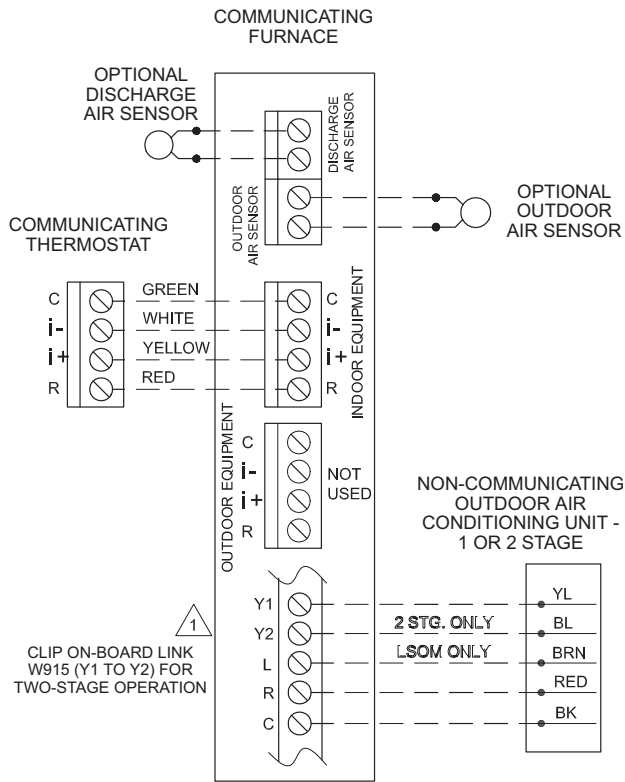

Communicating Enabled Furnace with a Communicating Enabled Outdoor Unit

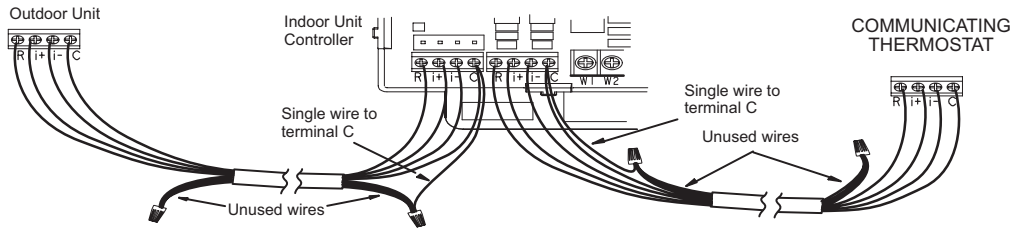
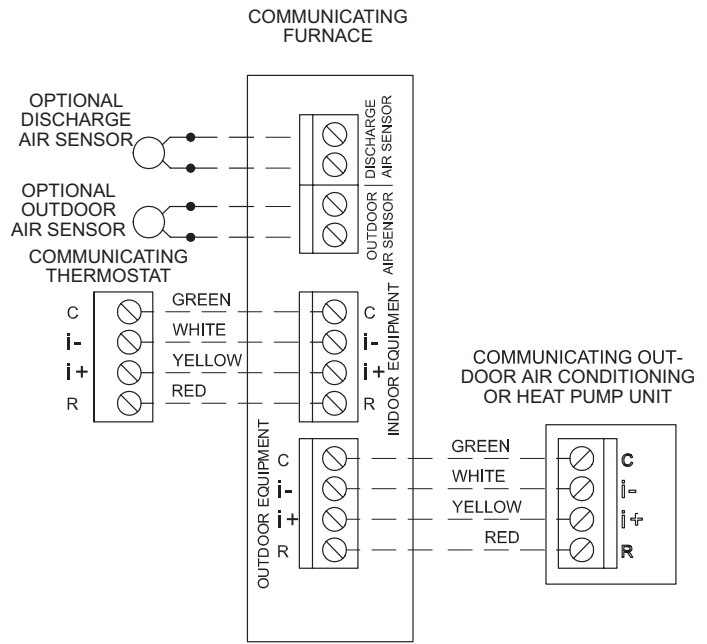

Communicating systems using the Communicating thermostat require four thermostat wires between the thermostat and the furnace/air handler control and four wires between the outdoor unit and the furnace/air handler control. When a thermostat cable with more than four wires is used, the extra wires must be properly connected to avoid electrical noise. The wires must not be left disconnected.

Use wire nuts to bundle the four unused wires at each end of the cable. A single wire should then be connected to the indoor unit end of the wire bundle and attached to the "C" terminals as shown above.

Optional Accessories for use with any Communicating System

NOTE: ICOMMUNICATING THERMOSTAT SENSES HUMIDITY & CONTROLS HUM CONTACTS TO CYCLE HUMIDIFIER BASED ON DEMAND. NO OTHER CONTROL OR HUMIDISTAT REQUIRED.

OPTIONAL OUTDOOR AIR SENSOR FOR USE WITH HUMIDIFIER (IF NOT ALREADY IN THE SYSTEM FOR OTHER FUNCTIONS. BUILT INTO ALL COMMUNICATING ENABLED OUT DOOR UNITS).

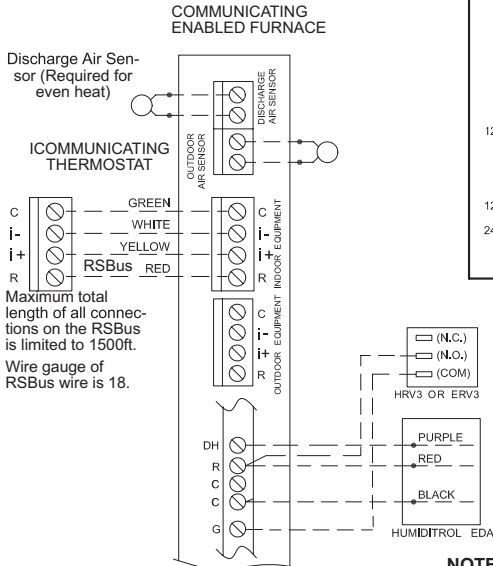
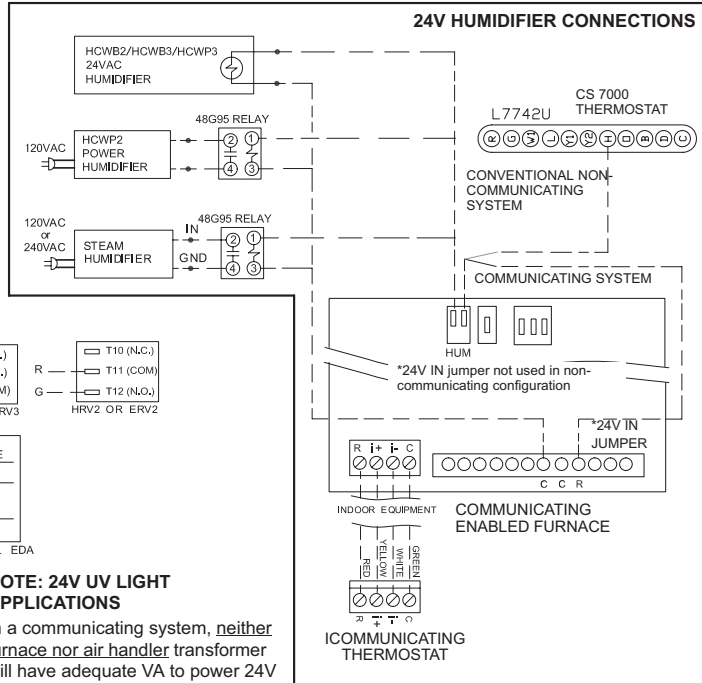
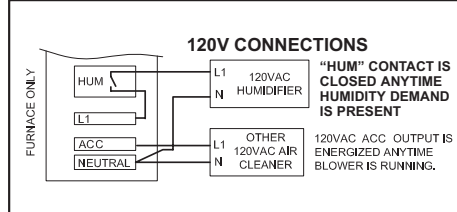

Maximum total length of all connections on the RSBUS is limited to 1500ft. Wire gauge of RSBUS wire is 18.

NOTE: 24V UV LIGHT APPLICATIONS

In a communicating system, neither furnace nor air handler transformer will have adequate VA to power 24V UV light applications. An additional transformer for UV light applications is required.

HEPA BYPASS FILTER X2680 HEPA INTERLOCK KIT

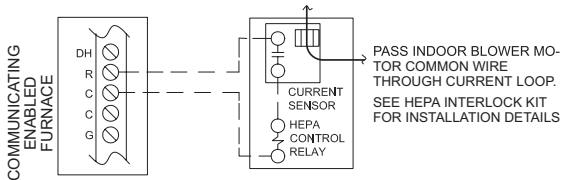

LVCS VENTILATION CONTROL SYSTEM

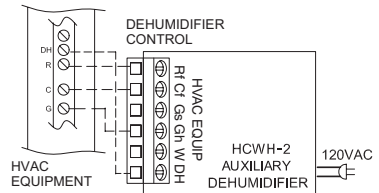
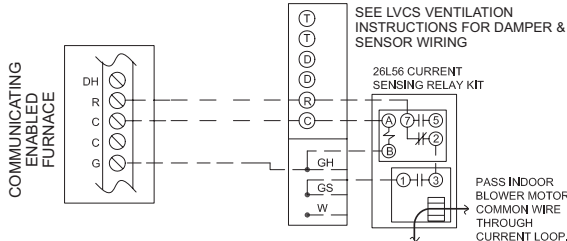

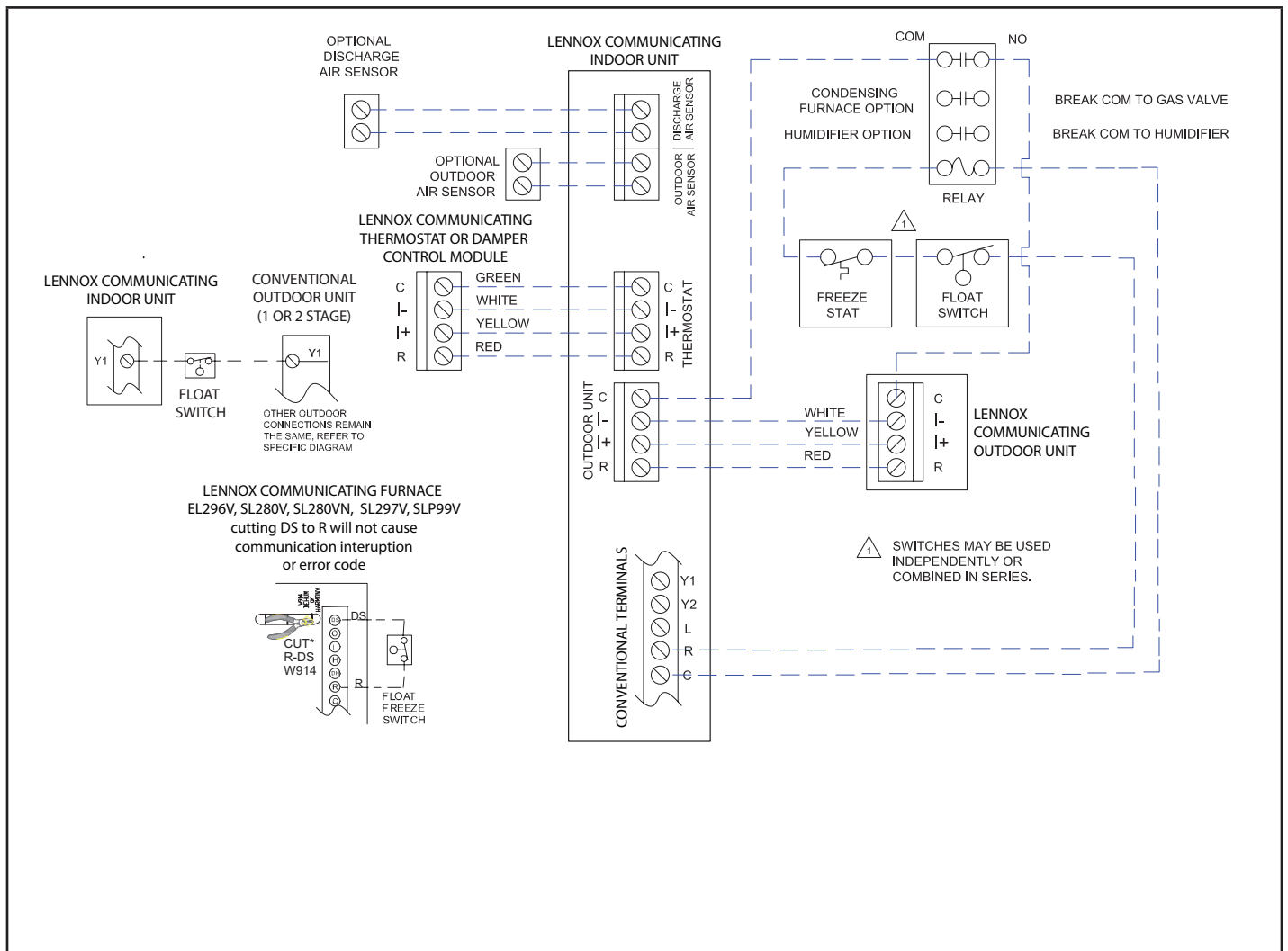

Ignition Control 103130-XX DIP Switch Settings and On Board Links

Thermostat	DIP Switch Settings and On-Board Links		Wiring Connections																														
	DIP Switch 1 Thermostat Heating Stages	On Board Links Must Be Cut To Select System Options																															
1 Heat / 1 Cool <i>NOTE - Use DIP switch 2 to set second-stage heat ON delay. OFF-7 minutes. ON-12 minutes.</i>	ON	DO NOT CUT ANY ON-BOARD LINKS 	<table border="0"> <tr> <td>S1 T'STAT</td> <td>FURNACE TERM. STRIP</td> <td>OUTDOOR UNIT</td> </tr> <tr> <td></td> <td>(DS)</td> <td></td> </tr> <tr> <td>(W2)</td> <td>(W2)</td> <td></td> </tr> <tr> <td>(W1)-----</td> <td>(W1)</td> <td></td> </tr> <tr> <td>(R)-----</td> <td>(R)-----*</td> <td>(R)</td> </tr> <tr> <td>(G)-----</td> <td>(G)</td> <td></td> </tr> <tr> <td>(C)-----</td> <td>(C)-----</td> <td>(C)</td> </tr> <tr> <td></td> <td>(Y2)</td> <td></td> </tr> <tr> <td>(Y)-----</td> <td>(Y1)-----</td> <td>(Y1)</td> </tr> <tr> <td></td> <td>(O)</td> <td></td> </tr> </table>	S1 T'STAT	FURNACE TERM. STRIP	OUTDOOR UNIT		(DS)		(W2)	(W2)		(W1)-----	(W1)		(R)-----	(R)-----*	(R)	(G)-----	(G)		(C)-----	(C)-----	(C)		(Y2)		(Y)-----	(Y1)-----	(Y1)		(O)	
S1 T'STAT	FURNACE TERM. STRIP	OUTDOOR UNIT																															
	(DS)																																
(W2)	(W2)																																
(W1)-----	(W1)																																
(R)-----	(R)-----*	(R)																															
(G)-----	(G)																																
(C)-----	(C)-----	(C)																															
	(Y2)																																
(Y)-----	(Y1)-----	(Y1)																															
	(O)																																
1 Heat / 2 Cool <i>NOTE - Use DIP switch 2 to set second-stage heat ON delay. OFF-7 minutes. ON-12 minutes.</i>	ON	CUT ON-BOARD LINK W915 2 STAGE COMPR 	<table border="0"> <tr> <td>S1 T'STAT</td> <td>FURNACE TERM. STRIP</td> <td>OUTDOOR UNIT</td> </tr> <tr> <td></td> <td>(DS)</td> <td></td> </tr> <tr> <td></td> <td>(W2)</td> <td></td> </tr> <tr> <td>(W)-----</td> <td>(W1)</td> <td></td> </tr> <tr> <td>(R)-----</td> <td>(R)-----*</td> <td>(R)</td> </tr> <tr> <td>(G)-----</td> <td>(G)</td> <td></td> </tr> <tr> <td>(C)-----</td> <td>(C)-----</td> <td>(C)</td> </tr> <tr> <td>(Y2)-----</td> <td>(Y2)</td> <td>(Y2)</td> </tr> <tr> <td>(Y1)-----</td> <td>(Y1)</td> <td>(Y1)</td> </tr> <tr> <td></td> <td>(O)</td> <td></td> </tr> </table>	S1 T'STAT	FURNACE TERM. STRIP	OUTDOOR UNIT		(DS)			(W2)		(W)-----	(W1)		(R)-----	(R)-----*	(R)	(G)-----	(G)		(C)-----	(C)-----	(C)	(Y2)-----	(Y2)	(Y2)	(Y1)-----	(Y1)	(Y1)		(O)	
S1 T'STAT	FURNACE TERM. STRIP	OUTDOOR UNIT																															
	(DS)																																
	(W2)																																
(W)-----	(W1)																																
(R)-----	(R)-----*	(R)																															
(G)-----	(G)																																
(C)-----	(C)-----	(C)																															
(Y2)-----	(Y2)	(Y2)																															
(Y1)-----	(Y1)	(Y1)																															
	(O)																																
1 Heat / 2 Cool with t'stat with humidity control <i>NOTE - Use DIP switch 2 to set second-stage heat ON delay. OFF-7 minutes. ON-12 minutes.</i>	ON	CUT ON-BOARD LINK W915 2 STAGE COMPR CUT ON-BOARD LINK W914 DEHUM OR HARMONY 	<table border="0"> <tr> <td>S1 T'STAT</td> <td>FURNACE TERM. STRIP</td> <td>OUTDOOR UNIT</td> </tr> <tr> <td>(DS)-----</td> <td>(DS)</td> <td></td> </tr> <tr> <td></td> <td>(W2)</td> <td></td> </tr> <tr> <td>(W1)-----</td> <td>(W1)</td> <td></td> </tr> <tr> <td>(R)-----</td> <td>(R)-----*</td> <td>(R)</td> </tr> <tr> <td>(G)-----</td> <td>(G)</td> <td></td> </tr> <tr> <td>(C)-----</td> <td>(C)-----</td> <td>(C)</td> </tr> <tr> <td>(Y2)-----</td> <td>(Y2)</td> <td>(Y2)</td> </tr> <tr> <td>(Y1)-----</td> <td>(Y1)</td> <td>(Y1)</td> </tr> <tr> <td></td> <td>(O)</td> <td></td> </tr> </table>	S1 T'STAT	FURNACE TERM. STRIP	OUTDOOR UNIT	(DS)-----	(DS)			(W2)		(W1)-----	(W1)		(R)-----	(R)-----*	(R)	(G)-----	(G)		(C)-----	(C)-----	(C)	(Y2)-----	(Y2)	(Y2)	(Y1)-----	(Y1)	(Y1)		(O)	
S1 T'STAT	FURNACE TERM. STRIP	OUTDOOR UNIT																															
(DS)-----	(DS)																																
	(W2)																																
(W1)-----	(W1)																																
(R)-----	(R)-----*	(R)																															
(G)-----	(G)																																
(C)-----	(C)-----	(C)																															
(Y2)-----	(Y2)	(Y2)																															
(Y1)-----	(Y1)	(Y1)																															
	(O)																																

* Not required on all units.

Ignition Control 103130-XX DIP Switch Settings and On Board Links

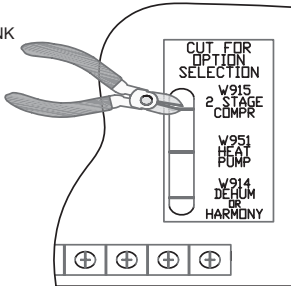
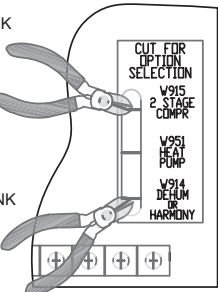
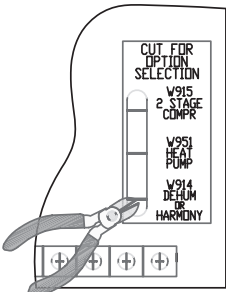
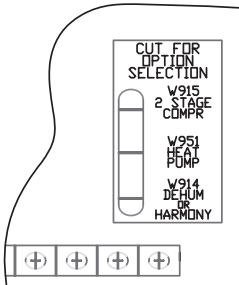
Thermostat	DIP Switch Settings and On-Board Links		Wiring Connections																														
	DIP Switch 1 Thermostat Heating Stages	On Board Links Must Be Cut To Select System Options																															
2 Heat / 2 Cool	OFF	<p>CUT ON-BOARD LINK W915 2 STAGE COMPR</p> 	<table border="0"> <thead> <tr> <th>S1 T'STAT</th> <th>FURNACE TERM. STRIP</th> <th>OUTDOOR UNIT</th> </tr> </thead> <tbody> <tr> <td>(W2)-----</td> <td>(DB)</td> <td></td> </tr> <tr> <td>(W1)-----</td> <td>(W2)</td> <td></td> </tr> <tr> <td>(R)-----</td> <td>(W1)</td> <td></td> </tr> <tr> <td>(G)-----</td> <td>(R)-----*</td> <td>(R)</td> </tr> <tr> <td>(C)-----</td> <td>(G)</td> <td></td> </tr> <tr> <td>(Y2)-----</td> <td>(C)</td> <td>(C)</td> </tr> <tr> <td>(Y1)-----</td> <td>(Y2)</td> <td>(Y2)</td> </tr> <tr> <td></td> <td>(Y1)</td> <td>(Y1)</td> </tr> <tr> <td></td> <td>(O)</td> <td></td> </tr> </tbody> </table>	S1 T'STAT	FURNACE TERM. STRIP	OUTDOOR UNIT	(W2)-----	(DB)		(W1)-----	(W2)		(R)-----	(W1)		(G)-----	(R)-----*	(R)	(C)-----	(G)		(Y2)-----	(C)	(C)	(Y1)-----	(Y2)	(Y2)		(Y1)	(Y1)		(O)	
S1 T'STAT	FURNACE TERM. STRIP	OUTDOOR UNIT																															
(W2)-----	(DB)																																
(W1)-----	(W2)																																
(R)-----	(W1)																																
(G)-----	(R)-----*	(R)																															
(C)-----	(G)																																
(Y2)-----	(C)	(C)																															
(Y1)-----	(Y2)	(Y2)																															
	(Y1)	(Y1)																															
	(O)																																
2 Heat / 2 Cool with t'stat with humidity control	OFF	<p>CUT ON-BOARD LINK W915 2 STAGE COMPR</p> <p>CUT ON-BOARD LINK W914 DEHUM OR HARMONY</p> 	<table border="0"> <thead> <tr> <th>S1 T'STAT</th> <th>FURNACE TERM. STRIP</th> <th>OUTDOOR UNIT</th> </tr> </thead> <tbody> <tr> <td>(DB)-----</td> <td>(DB)</td> <td></td> </tr> <tr> <td>(W2)-----</td> <td>(W2)</td> <td></td> </tr> <tr> <td>(W1)-----</td> <td>(W1)</td> <td></td> </tr> <tr> <td>(R)-----</td> <td>(R)-----*</td> <td>(R)</td> </tr> <tr> <td>(G)-----</td> <td>(G)</td> <td></td> </tr> <tr> <td>(C)-----</td> <td>(C)</td> <td>(C)</td> </tr> <tr> <td>(Y2)-----</td> <td>(Y2)</td> <td>(Y2)</td> </tr> <tr> <td>(Y1)-----</td> <td>(Y1)</td> <td>(Y1)</td> </tr> <tr> <td></td> <td>(O)</td> <td></td> </tr> </tbody> </table>	S1 T'STAT	FURNACE TERM. STRIP	OUTDOOR UNIT	(DB)-----	(DB)		(W2)-----	(W2)		(W1)-----	(W1)		(R)-----	(R)-----*	(R)	(G)-----	(G)		(C)-----	(C)	(C)	(Y2)-----	(Y2)	(Y2)	(Y1)-----	(Y1)	(Y1)		(O)	
S1 T'STAT	FURNACE TERM. STRIP	OUTDOOR UNIT																															
(DB)-----	(DB)																																
(W2)-----	(W2)																																
(W1)-----	(W1)																																
(R)-----	(R)-----*	(R)																															
(G)-----	(G)																																
(C)-----	(C)	(C)																															
(Y2)-----	(Y2)	(Y2)																															
(Y1)-----	(Y1)	(Y1)																															
	(O)																																
2 Heat / 1 Cool with t'stat with humidity control	OFF	<p>CUT ON-BOARD LINK W914 DEHUM OR HARMONY</p> 	<table border="0"> <thead> <tr> <th>S1 T'STAT</th> <th>FURNACE TERM. STRIP</th> <th>OUTDOOR UNIT</th> </tr> </thead> <tbody> <tr> <td>(DB)-----</td> <td>(DB)</td> <td></td> </tr> <tr> <td>(W2)-----</td> <td>(W2)</td> <td></td> </tr> <tr> <td>(W1)-----</td> <td>(W1)</td> <td></td> </tr> <tr> <td>(R)-----</td> <td>(R)-----*</td> <td>(R)</td> </tr> <tr> <td>(G)-----</td> <td>(G)</td> <td></td> </tr> <tr> <td>(C)-----</td> <td>(C)</td> <td>(C)</td> </tr> <tr> <td>(Y1)-----</td> <td>(Y1)</td> <td>(Y1)</td> </tr> <tr> <td></td> <td>(O)</td> <td></td> </tr> </tbody> </table>	S1 T'STAT	FURNACE TERM. STRIP	OUTDOOR UNIT	(DB)-----	(DB)		(W2)-----	(W2)		(W1)-----	(W1)		(R)-----	(R)-----*	(R)	(G)-----	(G)		(C)-----	(C)	(C)	(Y1)-----	(Y1)	(Y1)		(O)				
S1 T'STAT	FURNACE TERM. STRIP	OUTDOOR UNIT																															
(DB)-----	(DB)																																
(W2)-----	(W2)																																
(W1)-----	(W1)																																
(R)-----	(R)-----*	(R)																															
(G)-----	(G)																																
(C)-----	(C)	(C)																															
(Y1)-----	(Y1)	(Y1)																															
	(O)																																
2 Heat / 1 Cool	OFF	<p>DO NOT CUT ANY ON-BOARD LINKS</p> 	<table border="0"> <thead> <tr> <th>S1 T'STAT</th> <th>FURNACE TERM. STRIP</th> <th>OUTDOOR UNIT</th> </tr> </thead> <tbody> <tr> <td>(W2)-----</td> <td>(DB)</td> <td></td> </tr> <tr> <td>(W1)-----</td> <td>(W2)</td> <td></td> </tr> <tr> <td>(R)-----</td> <td>(W1)</td> <td></td> </tr> <tr> <td>(G)-----</td> <td>(R)-----*</td> <td>(R)</td> </tr> <tr> <td>(C)-----</td> <td>(G)</td> <td></td> </tr> <tr> <td></td> <td>(C)</td> <td>(C)</td> </tr> <tr> <td>(Y)-----</td> <td>(Y2)</td> <td></td> </tr> <tr> <td></td> <td>(Y1)</td> <td>(Y1)</td> </tr> <tr> <td></td> <td>(O)</td> <td></td> </tr> </tbody> </table>	S1 T'STAT	FURNACE TERM. STRIP	OUTDOOR UNIT	(W2)-----	(DB)		(W1)-----	(W2)		(R)-----	(W1)		(G)-----	(R)-----*	(R)	(C)-----	(G)			(C)	(C)	(Y)-----	(Y2)			(Y1)	(Y1)		(O)	
S1 T'STAT	FURNACE TERM. STRIP	OUTDOOR UNIT																															
(W2)-----	(DB)																																
(W1)-----	(W2)																																
(R)-----	(W1)																																
(G)-----	(R)-----*	(R)																															
(C)-----	(G)																																
	(C)	(C)																															
(Y)-----	(Y2)																																
	(Y1)	(Y1)																															
	(O)																																

* Not required on all units.

Ignition Control 103130-XX DIP Switch Settings and On Board Links

Thermostat	DIP Switch Settings and On-Board Links		Wiring Connections																																													
	DIP Switch 1 Thermostat Heating Stages	On Board Links Must Be Cut To Select System Options																																														
Dual Fuel Single Stage Heat Pump ComfortSense thermostat w/ dual fuel capabilities Capable of 2 stage gas heat control	OFF		<table border="0"> <tr> <td>T'STAT</td> <td>FURNACE TERM. STRIP</td> <td>HEAT PUMP</td> </tr> <tr> <td>(R) ---</td> <td>(R) ---</td> <td>(R) ---</td> </tr> <tr> <td>(H) ---</td> <td></td> <td></td> </tr> <tr> <td>(W2) ---</td> <td>(W2) 67M41*</td> <td></td> </tr> <tr> <td>(W1) ---</td> <td>(W1) ← ○ → (W1)</td> <td></td> </tr> <tr> <td>(O) ---</td> <td>(O) ---</td> <td>(O) ---</td> </tr> <tr> <td>(L) ---</td> <td></td> <td>(L) ---</td> </tr> <tr> <td>(Y1) ---</td> <td>(Y1) ---</td> <td>(Y) ---</td> </tr> <tr> <td>(Y2) ---</td> <td></td> <td></td> </tr> <tr> <td>(G) ---</td> <td>(G) ---</td> <td></td> </tr> <tr> <td>(D) ---</td> <td>(DS) ---</td> <td></td> </tr> <tr> <td>(B) ---</td> <td>(Y2) ---</td> <td></td> </tr> <tr> <td>(C) ---</td> <td>(C) ---</td> <td>(C) ---</td> </tr> <tr> <td>(T) ---</td> <td></td> <td>outdoor sensor</td> </tr> <tr> <td>(T) ---</td> <td></td> <td></td> </tr> </table>	T'STAT	FURNACE TERM. STRIP	HEAT PUMP	(R) ---	(R) ---	(R) ---	(H) ---			(W2) ---	(W2) 67M41*		(W1) ---	(W1) ← ○ → (W1)		(O) ---	(O) ---	(O) ---	(L) ---		(L) ---	(Y1) ---	(Y1) ---	(Y) ---	(Y2) ---			(G) ---	(G) ---		(D) ---	(DS) ---		(B) ---	(Y2) ---		(C) ---	(C) ---	(C) ---	(T) ---		outdoor sensor	(T) ---		
T'STAT	FURNACE TERM. STRIP	HEAT PUMP																																														
(R) ---	(R) ---	(R) ---																																														
(H) ---																																																
(W2) ---	(W2) 67M41*																																															
(W1) ---	(W1) ← ○ → (W1)																																															
(O) ---	(O) ---	(O) ---																																														
(L) ---		(L) ---																																														
(Y1) ---	(Y1) ---	(Y) ---																																														
(Y2) ---																																																
(G) ---	(G) ---																																															
(D) ---	(DS) ---																																															
(B) ---	(Y2) ---																																															
(C) ---	(C) ---	(C) ---																																														
(T) ---		outdoor sensor																																														
(T) ---																																																
Dual Fuel Two Stage Heat Pump ComfortSense thermostat w/ dual fuel capabilities Capable of 2 stage gas heat control	OFF		<table border="0"> <tr> <td>T'STAT</td> <td>FURNACE TERM. STRIP</td> <td>HEAT PUMP</td> </tr> <tr> <td>(R) ---</td> <td>(R) ---</td> <td>(R) ---</td> </tr> <tr> <td>(H) ---</td> <td></td> <td></td> </tr> <tr> <td>(W2) ---</td> <td>(W2) 67M41*</td> <td></td> </tr> <tr> <td>(W1) ---</td> <td>(W1) ← ○ → (W1)</td> <td></td> </tr> <tr> <td>(O) ---</td> <td>(O) ---</td> <td>(O) ---</td> </tr> <tr> <td>(L) ---</td> <td></td> <td>(L) ---</td> </tr> <tr> <td>(Y1) ---</td> <td>(Y1) ---</td> <td>(Y1) ---</td> </tr> <tr> <td>(Y2) ---</td> <td></td> <td>(Y2) ---</td> </tr> <tr> <td>(G) ---</td> <td>(G) ---</td> <td></td> </tr> <tr> <td>(D) ---</td> <td>(DS) ---</td> <td></td> </tr> <tr> <td>(B) ---</td> <td>(Y2) ---</td> <td>Y2 out blue</td> </tr> <tr> <td>(C) ---</td> <td>(C) ---</td> <td>(C) ---</td> </tr> <tr> <td>(T) ---</td> <td></td> <td>outdoor sensor</td> </tr> <tr> <td>(T) ---</td> <td></td> <td></td> </tr> </table>	T'STAT	FURNACE TERM. STRIP	HEAT PUMP	(R) ---	(R) ---	(R) ---	(H) ---			(W2) ---	(W2) 67M41*		(W1) ---	(W1) ← ○ → (W1)		(O) ---	(O) ---	(O) ---	(L) ---		(L) ---	(Y1) ---	(Y1) ---	(Y1) ---	(Y2) ---		(Y2) ---	(G) ---	(G) ---		(D) ---	(DS) ---		(B) ---	(Y2) ---	Y2 out blue	(C) ---	(C) ---	(C) ---	(T) ---		outdoor sensor	(T) ---		
T'STAT	FURNACE TERM. STRIP	HEAT PUMP																																														
(R) ---	(R) ---	(R) ---																																														
(H) ---																																																
(W2) ---	(W2) 67M41*																																															
(W1) ---	(W1) ← ○ → (W1)																																															
(O) ---	(O) ---	(O) ---																																														
(L) ---		(L) ---																																														
(Y1) ---	(Y1) ---	(Y1) ---																																														
(Y2) ---		(Y2) ---																																														
(G) ---	(G) ---																																															
(D) ---	(DS) ---																																															
(B) ---	(Y2) ---	Y2 out blue																																														
(C) ---	(C) ---	(C) ---																																														
(T) ---		outdoor sensor																																														
(T) ---																																																

* Connect W1 to W1 ONLY if using defrost tempering kit 67M41

NOTE - **Do NOT** make a wire connection between the room thermostat L terminal and the L terminal of the furnace integrated control.

Ignition Control 103130-XX DIP Switch Settings and On Board Links

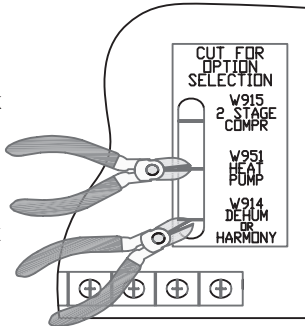
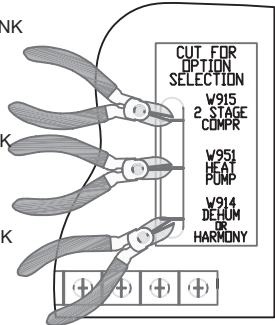
Thermostat	DIP Switch Settings and On-Board Links		Wiring Connections																																													
	DIP Switch 1 Thermostat Heating Stages	On Board Links Must Be Cut To Select System Options																																														
<p>Dual Fuel Single Stage Heat Pump</p> <p>ComfortSense thermostat w/ dual fuel capa- bilities Capable of 2 stage gas heat control w/dehu- midification control</p>	OFF	<p>CUT ON-BOARD LINK W951 HEAT PUMP</p> <p>CUT ON-BOARD LINK W914 DEHUM OR HARMONY</p> 	<table border="0"> <thead> <tr> <th>T'STAT</th> <th>FURNACE TERM. STRIP</th> <th>HEAT PUMP</th> </tr> </thead> <tbody> <tr><td>R</td><td>R</td><td>R</td></tr> <tr><td>H</td><td></td><td></td></tr> <tr><td>W2</td><td>W2 67M41*</td><td></td></tr> <tr><td>W1</td><td>W1 ← → W1</td><td></td></tr> <tr><td>O</td><td>O</td><td>O</td></tr> <tr><td>L</td><td></td><td>L</td></tr> <tr><td>Y1</td><td>Y1</td><td>Y</td></tr> <tr><td>Y2</td><td></td><td></td></tr> <tr><td>G</td><td>G</td><td></td></tr> <tr><td>D</td><td>DS</td><td></td></tr> <tr><td>B</td><td>Y2</td><td></td></tr> <tr><td>C</td><td>C</td><td>C</td></tr> <tr><td>T</td><td></td><td></td></tr> <tr><td>T</td><td></td><td>outdoor sensor</td></tr> </tbody> </table>	T'STAT	FURNACE TERM. STRIP	HEAT PUMP	R	R	R	H			W2	W2 67M41*		W1	W1 ← → W1		O	O	O	L		L	Y1	Y1	Y	Y2			G	G		D	DS		B	Y2		C	C	C	T			T		outdoor sensor
T'STAT	FURNACE TERM. STRIP	HEAT PUMP																																														
R	R	R																																														
H																																																
W2	W2 67M41*																																															
W1	W1 ← → W1																																															
O	O	O																																														
L		L																																														
Y1	Y1	Y																																														
Y2																																																
G	G																																															
D	DS																																															
B	Y2																																															
C	C	C																																														
T																																																
T		outdoor sensor																																														
<p>Dual Fuel Two Stage Heat Pump</p> <p>ComfortSense thermostat w/ dual fuel capa- bilities Capable of 2 stage gas heat control w/dehu- midification</p>	OFF	<p>CUT ON-BOARD LINK W915 2 STAGE COMPR</p> <p>CUT ON-BOARD LINK W951 HEAT PUMP</p> <p>CUT ON-BOARD LINK W914 DEHUM OR HARMONY</p> 	<table border="0"> <thead> <tr> <th>T'STAT</th> <th>FURNACE TERM. STRIP</th> <th>HEAT PUMP</th> </tr> </thead> <tbody> <tr><td>R</td><td>R</td><td>R</td></tr> <tr><td>H</td><td></td><td></td></tr> <tr><td>W2</td><td>W2 67M41*</td><td></td></tr> <tr><td>W1</td><td>W1 ← → W1</td><td></td></tr> <tr><td>O</td><td>O</td><td>O</td></tr> <tr><td>L</td><td></td><td>L</td></tr> <tr><td>Y1</td><td>Y1</td><td>Y1</td></tr> <tr><td>Y2</td><td></td><td>Y2</td></tr> <tr><td>G</td><td>G</td><td></td></tr> <tr><td>D</td><td>DS</td><td></td></tr> <tr><td>B</td><td>Y2</td><td>Y2 out blue</td></tr> <tr><td>C</td><td>C</td><td>C</td></tr> <tr><td>T</td><td></td><td></td></tr> <tr><td>T</td><td></td><td>outdoor sensor</td></tr> </tbody> </table>	T'STAT	FURNACE TERM. STRIP	HEAT PUMP	R	R	R	H			W2	W2 67M41*		W1	W1 ← → W1		O	O	O	L		L	Y1	Y1	Y1	Y2		Y2	G	G		D	DS		B	Y2	Y2 out blue	C	C	C	T			T		outdoor sensor
T'STAT	FURNACE TERM. STRIP	HEAT PUMP																																														
R	R	R																																														
H																																																
W2	W2 67M41*																																															
W1	W1 ← → W1																																															
O	O	O																																														
L		L																																														
Y1	Y1	Y1																																														
Y2		Y2																																														
G	G																																															
D	DS																																															
B	Y2	Y2 out blue																																														
C	C	C																																														
T																																																
T		outdoor sensor																																														

* Connect W1 to W1 ONLY if using defrost tempering kit 67M41

NOTE - Do NOT make a wire connection between the room thermostat L terminal and the L terminal of the furnace integrated control.

IX- Program Unit Capacity Size Modes

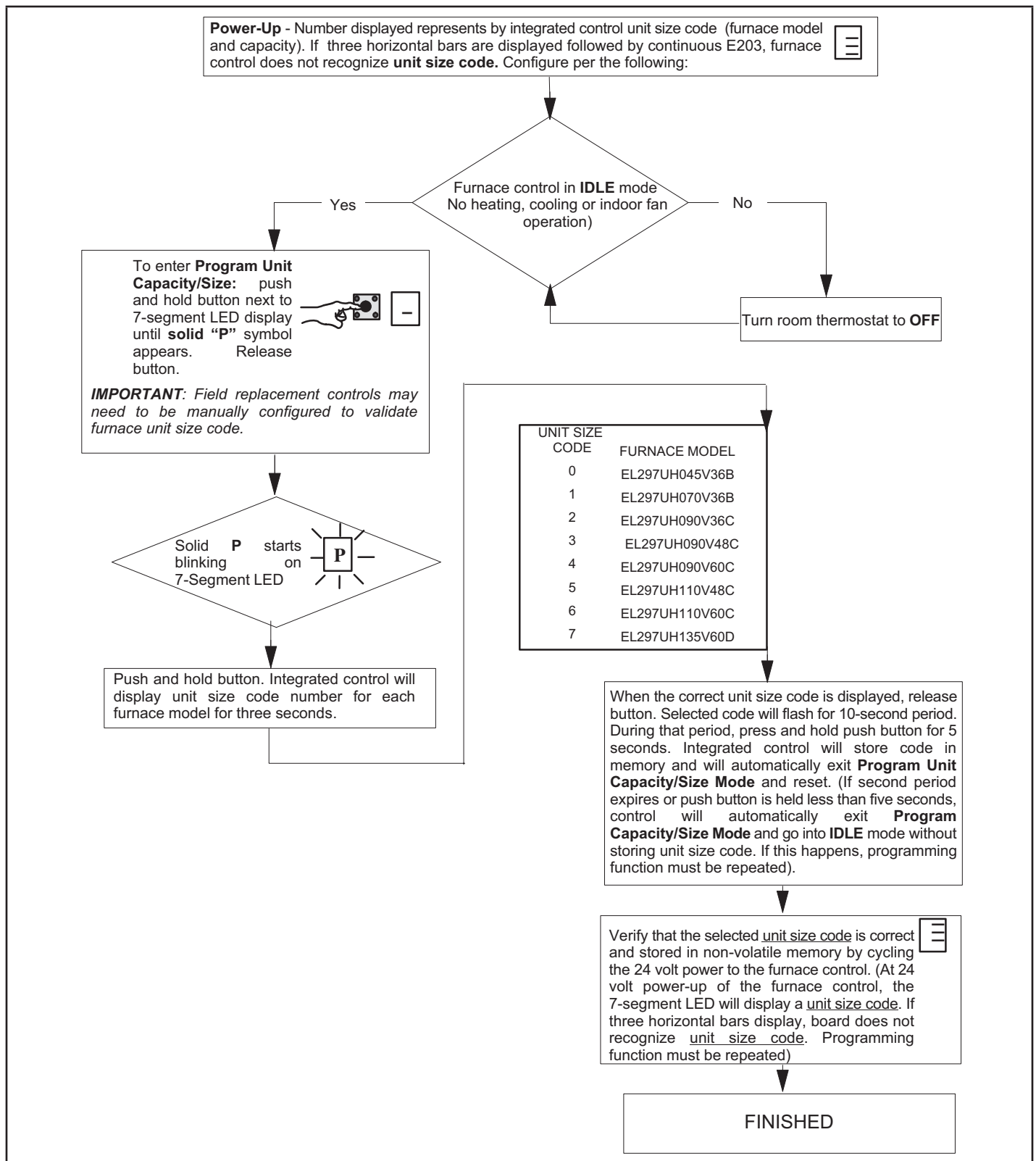

X- Troubleshooting

Troubleshooting: Heating Sequence of Operation

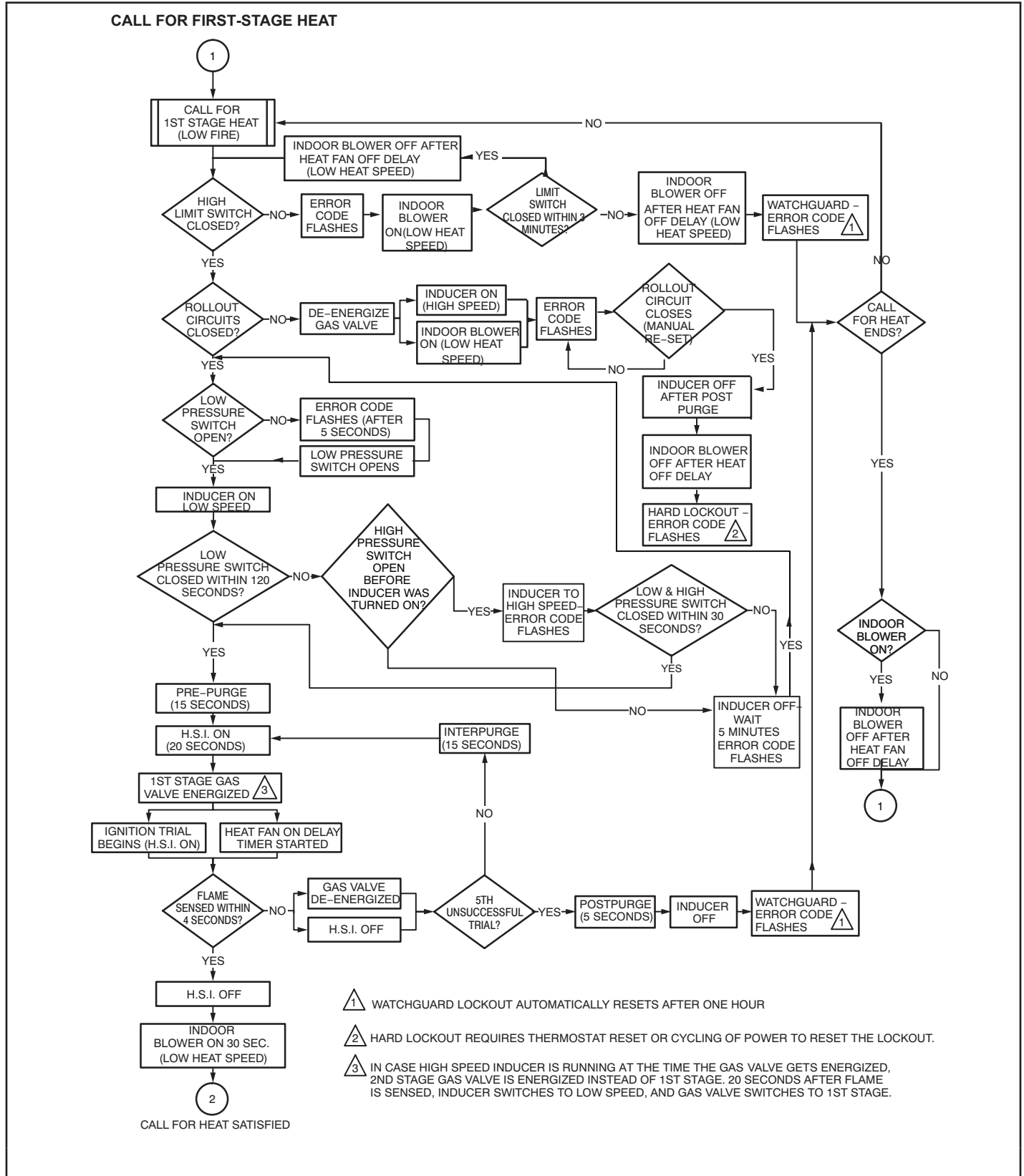

CALL FOR SECOND-STAGE HEAT

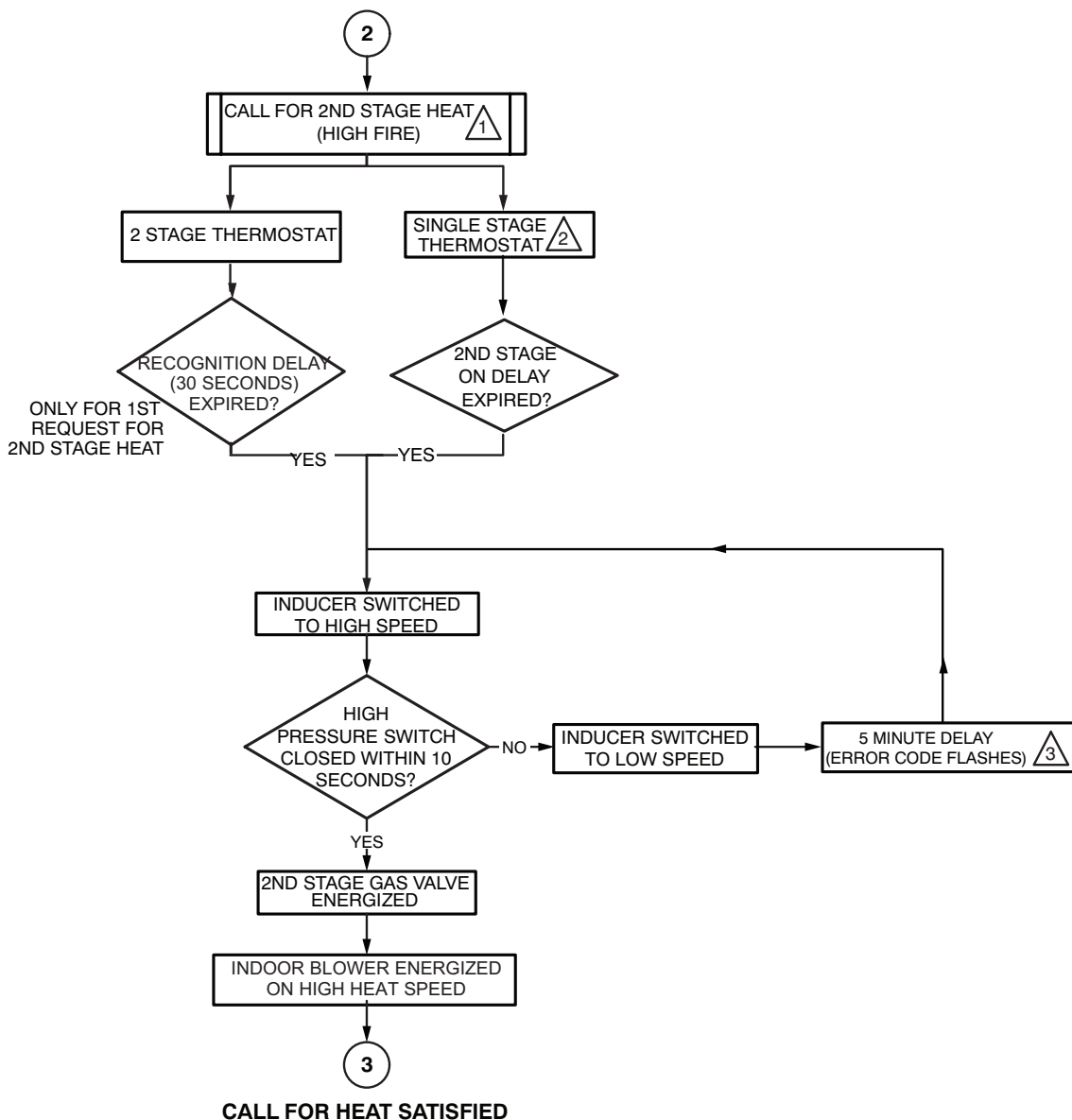

- 1 SYSTEM WILL ALWAYS LIGHT ON LOW FIIRE, EVEN IF 2ND STAGE HEAT IS IN PLACE.
- 2 WHEN USED WITH A SINGLE STAGE THERMOSTAT, SET SW1 TO THE ON POSITION IN DIP SWITCH S4.
- 3 IF THE HIGH FIRE PRESSURE SWITCH DOES NOT CLOSE WITHIN 5 ATTEMPTS, THE SYSTEM WILL OPERATE AT LOW FIRE FOR THE REMAINDER OF THE CALL FOR HEAT REQUEST.

CALL FOR HEAT SATISFIED

FIRST-STAGE HEAT SECOND-STAGE HEAT

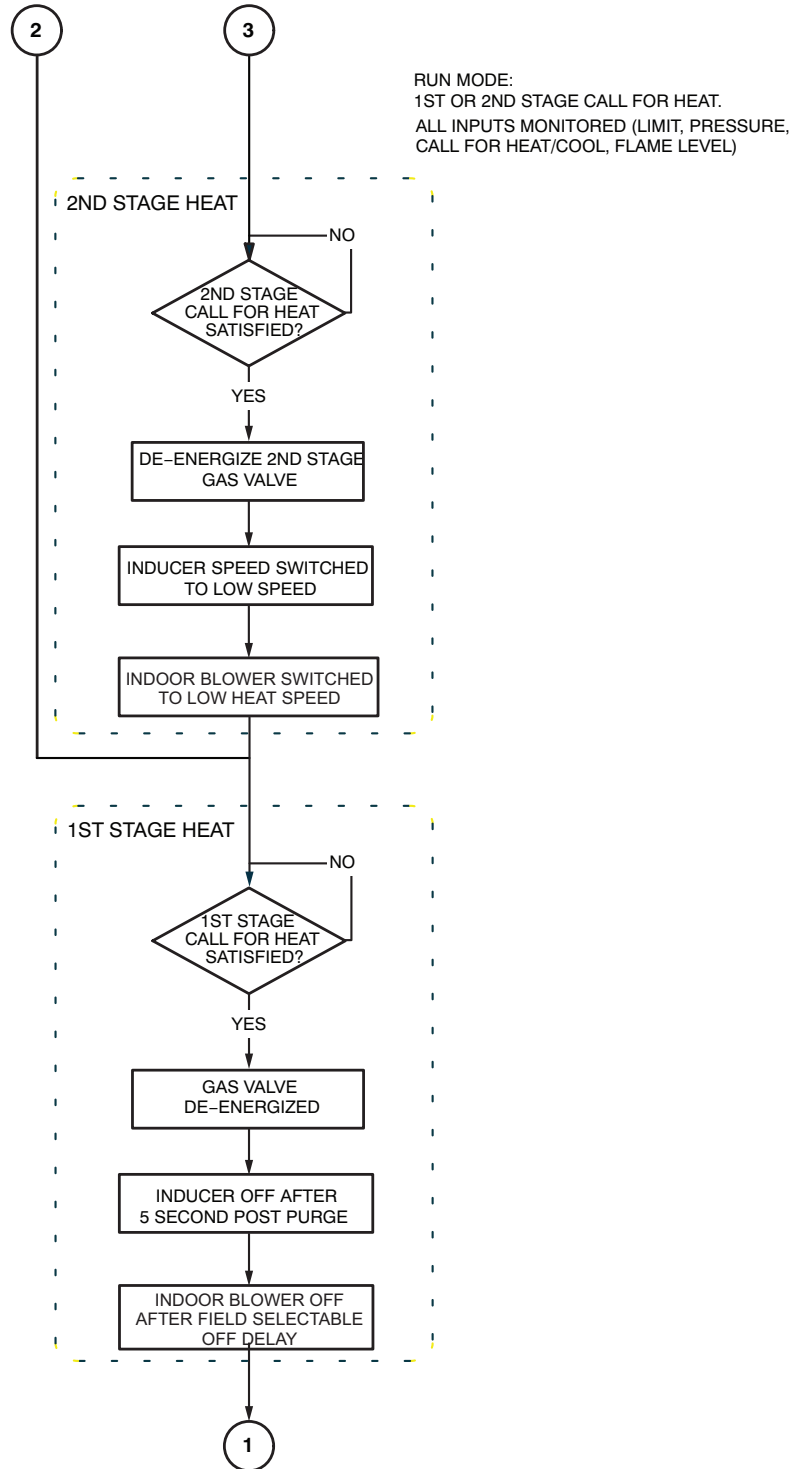

Troubleshooting: Cooling Sequence of Operation

CALL FOR COOLING

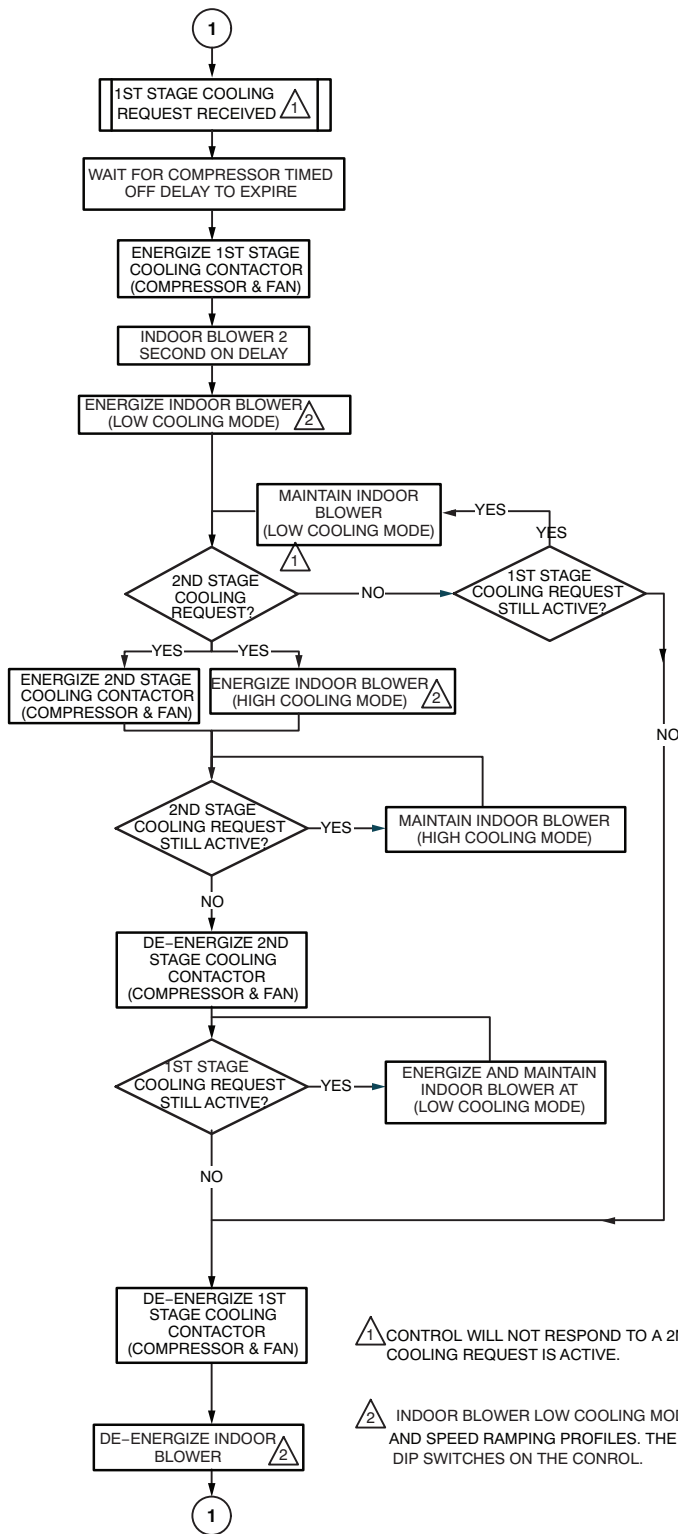

CALL FOR FAN

