



**ENERGY RECOVERY SYSTEMS**

For Enlight and Model L™ Rooftop Units | 60Hz

**COMMERCIAL  
PRODUCT SPECIFICATIONS (EHB)**

300 to 6200 cfm Capacity



**MODEL NUMBER IDENTIFICATION**

**50 R 06 49 x H 23 (Factory Options) (See codes below)**

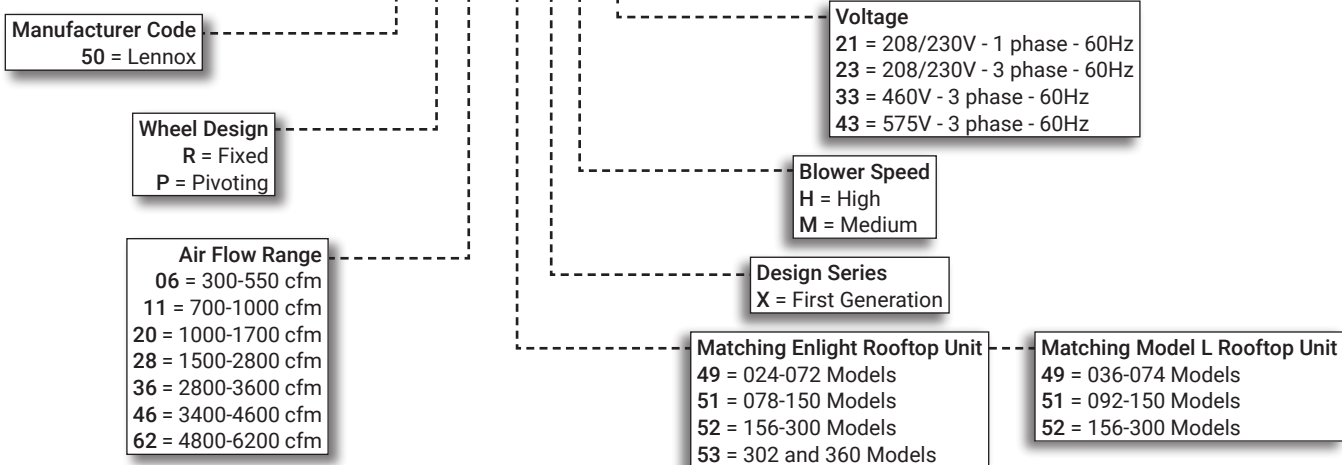

**Factory Option Codes**

**L M E S P R D V F F E**

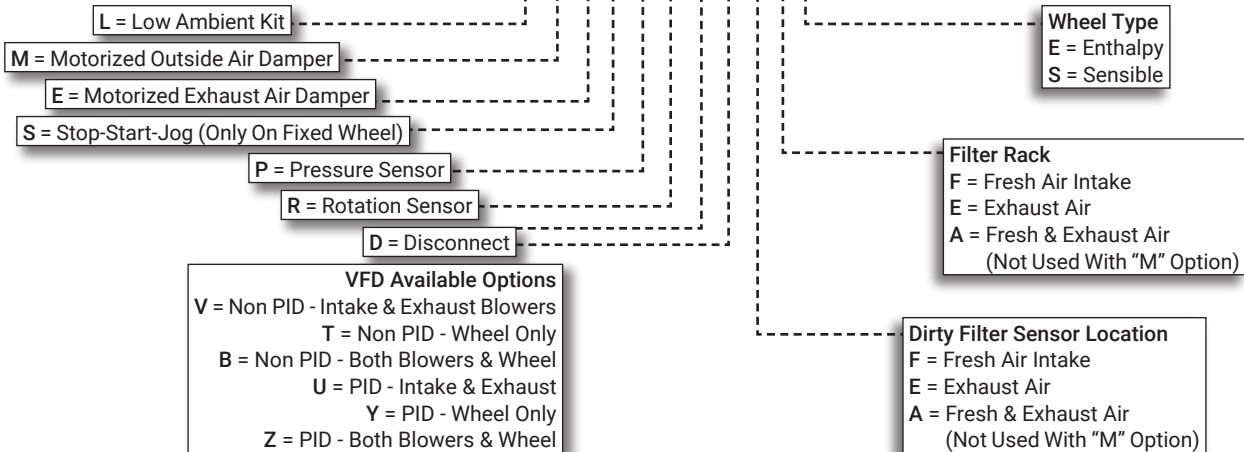

**NOTES:**

x = Factory Option Not Selected e.g. 50R0649xH23LxEsRx  
 ERS is a Fixed wheel with 300-550 CFM for the 036-060 Unit with a Low Ambient Kit, Motorized Exhaust Air Damper, Stop-Start Jog, Rotation Sensor, Disconnect, VFD - Non PID, Dirty Filter Sensor in Exhaust Air and an Enthalpy Wheel.

## CONTENTS

Dimensions . . . . .	10
Electrical Data . . . . .	9
Approvals And Warranty . . . . .	2
Features And Benefits . . . . .	2
Guide Specifications . . . . .	13
Model Number Identification. . . . .	1
Options / Accessories - Order Separately . . . . .	15
Specifications . . . . .	4
2 To 6 Ton Models . . . . .	4
6.5 To 12.5 Ton Models . . . . .	5
13 To 25 Ton Models . . . . .	6
Unit Clearances . . . . .	11

## FEATURES AND BENEFITS

### APPLICATIONS

The Lennox Energy Recovery System (ERS) is a constant volume, energy recovery ventilator that is directly coupled with Lennox Enlight or Model L™ rooftop units. Its primary function is to increase overall HVAC system efficiency and to reduce long-term energy costs.

This is accomplished by capturing both sensible and latent energy from either the exhaust or intake air stream and transferring it to the other, resulting in reduced cooling loads at design temperatures up to four tons per 1000 cfm of outside air and reduced heating loads up to 12,000 Btuh per 400 cfm of outside air.

The recovery wheel provides sensible and latent energy exchange between the entering and exhaust air streams of a building allowing a substantial amount of the energy, which is normally lost in the exhaust air stream, to be returned into the entering air.

Each unit factory test operated to ensure proper operation.

### OPERATION

- The enthalpy wheel contains parallel layers of a polymeric material that is physically embedded with a silica gel (desiccant)
- The wheel is located in the intake and exhaust air streams of the ventilation equipment
- As the wheel rotates through each air stream, the wheel surface captures sensible and latent energy
- In the heating mode, the wheel rotates to provide a constant transfer of heat from the exhaust air stream to the colder intake air stream
- During the cooling season, the process is reversed
- When used in conjunction with a rooftop unit equipped with an economizer, on pivoting models, the wheel pivots out of the air stream to allow the economizer to operate normally for “free cooling” when outdoor temperature and humidity is acceptable
- By pivoting the wheel out of the air stream, the system can utilize 100% of the rooftop unit’s blower capabilities
- During economizer operation, the exhaust blower continues to run, providing power exhaust for the system
- The intake blower is de-energized during economizer operation

## APPROVALS AND WARRANTY

### APPROVALS

- Rated in accordance with AHRI standard 1060-2023
- To obtain a copy of the Standard or to view Lennox’ latest certified data, please visit the AHRI web site at <http://www.ahrinet.org>
- ETL Certified per UL 1995 and CSA/CAN C22.2 No. 236

### WARRANTY

- Recovery Wheel - limited warranty for five years
- All other covered components - one year limited warranty

### ERS SELECTION

- **Step One** - Determine the air conditioning load requirements using the required amount of outside air without an ERS
- **Step Two** - Select the proper ERS for the outside air requirements and calculate the tonnage reduction.
- Select the rooftop unit required by reducing the load determined in step one by the reduction in step two
- Example: If the load in Step 1 was 10 tons, and the reduction in Step 2 was 2.5 tons, select a 7.5 ton unit.
- Select the proper ERS based on the selected unit

**NOTE** - The height of the roof top unit curb **MUST** correspond with the required curb height needed for the ERS. See Specifications Table.

### SYSTEM FEATURES

- Low-voltage logic board used to control frost protection and motorized outside air damper
- Low-voltage terminal strip
- Barometric relief dampers provided standard on all ERS units
- Balancing dampers provided standard on all fixed wheel ERS units
- Metal-mesh, mist-eliminator-type filters provided in intake air hood
- Separate, fused power supply
- Continuous operation down to 10°F without defrost at indoor relative humidity up to 40%
- For temperatures below 10°F an optional, factory installed Low Ambient Control Kit is required

## FEATURES AND BENEFITS

### RECOVERY WHEEL

#### AirXchange™ Enthalpy Wheels

- Capable of both sensible and latent heat recovery
- Dry energy transfer
- Moisture in supply air stream is transferred to exhaust air stream in vapor state, eliminating condensate plumbing in the ventilator
- Constructed of lightweight polymer material and coated with a desiccant silica gel that will not dissolve or liquefy in the presence of water or high humidity
- Wheels 25 in. (635 mm) and larger in diameter are segmented for easy removal. Wheels less than 25 in. (635 mm) diameter are removed from cabinet in a slide-out cassette
- Patented, pivoting-wheel option allows unit to operate in true economizer mode when the outside temperature is suitable for cooling
- Pivoting the wheel out of the air stream during economizer mode allows efficiencies to be maximized by reducing demand on the supply fan motor

### BLOWERS

- Centrifugal, forward curved blowers provided for high-static capability and low sound levels
- Belt-drive blowers have permanently lubricated ball bearings, overload protection, and adjustable sheaves for blower speed adjustment

### CABINET

- Fully insulated with non-hygroscopic fiberglass insulation. Constructed of galvanized steel and finished with electro-statically bonded powdered enamel coating to withstand 1000 hour salt-spray test per ASTM B117
- Attaches directly to the rooftop unit
- All mounting hardware is provided
- Adjustable support legs are provided

### Options / Accessories

#### Factory Installed

##### Low Ambient Control Kit

- Prevents frost formation on energy wheel heat transfer surfaces by terminating the intake blower operation when discharge air temperature falls below a field-selectable temperature setting
- Intake blower operation resumes after temperature rises above the adjustable temperature differential. Kit includes temperature sensor

##### Motorized Outside Air Damper

- Damper mounts behind the outside air intake hood and opens when the ERS is energized and closes when de-energized

##### Motorized Exhaust Air Damper

- Damper mounts in the barometric relief hood and opens when the ERS is energized and closes when de-energized

##### Stop-Start-Jog (Fixed Models Only)

- Control option that allows intermittent operation of the enthalpy wheel during mild outdoor conditions to provide cycling and cleaning of the wheel

##### Pressure Sensor

- Measures the amount of outside airflow across the enthalpy wheel

##### Rotation Sensor

- Verifies the rotation of the enthalpy wheel

##### Disconnect

- Optional field device used to provide easy ability to switching the power on and off to the ERS
- Must be field wired

##### VFD Blower Control

- Variable frequency drives are available to control the speed of the blowers only
- These VFD's can be integrated with a building automation system to deliver precisely the amount of air needed to maximize efficiencies

##### Dirty Filter Sensor

- The dirty filter sensor sends a signal to field wired alarm when filters need to be cleaned or changed

##### Filter Rack

- Filter racks filter air in both the intake and exhaust sections of ERS

##### Energy Recovery Wheel - Sensible Type

- Sensible Wheel type is used for sensible heat recovery

### Field Installed

#### ERS Support

- 8 inch high base for support of the exhaust and intake end of the ERS
- Available in 48, 60, 76 inch lengths
- See Page 15 for model numbers

#### ERS Roof Curb

- Used to support RTU and raise them to the correct height for mounting
- See Page 15 for model numbers

#### GFI Service Outlet

- Optional field powered service outlet provides power for service equipment
- Must be field installed and wired
- See Page 15 for model numbers

**NOTE** - Contact your local Lennox Commercial Sales Representative for ordering information.

**SPECIFICATIONS**

**2 TO 6 TON MODELS**

<b>General Data</b>	<b>Model Number Fixed Wheel</b>		<b><sup>2</sup>50R0649xH</b>			<b>50R1149xH</b>			<b>50R2049xH</b>		
	<b>Model Number Pivoting Wheel</b>		---			<b>50P1149xH</b>			<b>50P2049xH</b>		
Matching Units			Enlight - 024 through 060 models Model L - 036 through 060						Enlight - 072 models Model L - 074 models		
Nominal Air Volume - cfm			300-550			700-1000			1000-1700		
<b>Required Height of Rooftop Unit Curb - in.</b>			14			14			14		
<b>Fresh Air Blower</b>	Motor - hp		0.2			1/2			1		
	Wheel Size (diameter x width) - in		6-1/4 x 6-1/2			10 x 6			9 x 9		
	Motor Speed - rpm		1780			1120			1725		
	Motor Speed(s)		2			3			Adjustable Sheave		
	Bearing Type		Sleeve			Sleeve			Ball		
<b>Exhaust Air Blower</b>	Motor Type		PSC			PSC			Belt Drive		
	Motor - hp		1/4			1/2			1		
	Fixed Wheel		---			1/2			1-1/2		
	Pivoting Wheel		6-1/4 x 6-1/2			10 x 6			9 x 9		
	Wheel Size (diameter x width) - in		1780			1120			1725		
	Motor Speed - rpm		2			3			Adjustable Sheave		
	Motor Speed(s)		Sleeve			Sleeve			Ball		
Bearing Type		2 x 19-1/3			3 x 25-1/3			3 x 30-11/32			
<b>Recovery Wheel</b>	Wheel Depth x Diameter - in		1050			1050			1050		
<b>Electrical Data - Line Voltage - 60Hz</b>		<sup>2</sup> 208/230V-1ph, 208/230V-3ph, 460V-3ph, and 575V-3ph			208/230V-3ph, 460V-3ph, and 575V-3ph			208/230V-3ph, 460V-3ph, and 575V-3ph			
<b>Enthalpy Wheel Airflow Data</b>	Nominal Airflow		500 cfm at 0.6 in. w.c.			900 cfm at 1 in. w.c.			1600 cfm at 0.95 in. w.c.		
	EATR - Exhaust Air Transfer Ratio	at minus 1 in. w.c.	9.90%			9.30%			7.80%		
		at 0 in. w.c.	0.20%			0.70%			0.40%		
		at 1 in. w.c.	0.00%			0.00%			0.00%		
	OACF - Outdoor Air Correction Factor	at minus 1 in. w.c.	1.02%			0.97%			0.97%		
		at 0 in. w.c.	1.33%			1.19%			1.16%		
		at 1 in. w.c.	1.59%			1.34%			1.29%		
<b><sup>1</sup>Thermal Ratings at 0 in. w.c. Pressure Differential</b>	Total Effectiveness	100% Airflow Heating	Sensible	Latent	Total	Sensible	Latent	Total	Sensible	Latent	Total
		75% Airflow Heating	68%	60%	65%	76%	68%	73%	68%	61%	65%
		100% Airflow Cooling	73%	65%	70%	81%	73%	78%	72%	67%	71%
		75% Airflow Cooling	68%	60%	64%	76%	68%	72%	68%	61%	64%
	Net Effectiveness	100% Airflow Heating	73%	65%	69%	81%	73%	76%	72%	67%	70%
		75% Airflow Heating	68%	60%	65%	76%	68%	73%	68%	61%	65%
		100% Airflow Cooling	73%	65%	70%	81%	73%	78%	72%	67%	71%
		75% Airflow Cooling	68%	60%	64%	76%	68%	72%	68%	61%	64%
<b><sup>3</sup>Weights</b>	Fixed	Shipping Weight - lbs.	472			475			791		
		Net Weight - lbs.	455			458			706		
	Pivoting	Shipping Weight - lbs.	---			480			754		
		Net Weight - lbs.	---			463			669		

<sup>1</sup> Rated in accordance with AHRI Standard 1060-2011. For further information, please reference AHRI 1060-2011 Standard for Rating Air-to-Air Heat Exchangers For Energy Recovery Ventilation Equipment.

<sup>2</sup> A unit step-down transformer is provided, 208/230/460/575V primary, 120V secondary.

<sup>3</sup> Actual weight may vary and is dependent on configuration.

**SPECIFICATIONS**

**6.5 TO 12.5 TON MODELS**

<b>General Data</b>	<b>Model Number Fixed Wheel</b>		<b>50R2051xH</b>	<b>50R2851xM</b>	<b>50R2851xH</b>	<b>50R3651xH</b>								
	<b>Model Number Pivoting Wheel</b>		<b>50P2051xH</b>	<b>50P2851xM</b>	<b>50P2851xH</b>	<b>50P3651xH</b>								
	Nominal Air Volume - cfm		1000-1700	1500-2200	2200-2800	2800-3600								
	Matching Units		Enlight - 078 through 150 models Model L - 092 through 150 models											
<b>Required Height of Rooftop Unit Curb - in.</b>			14	14	14	24								
<b>Fresh Air Blower</b>	Belt-Drive Motor - hp		1	1-1/2	1-1/2	2								
	Wheel Size (diameter x width) - in.		9 x 9	10 x 10	10 x 10	12 x 9								
	Motor Speed - rpm		1725	1725	1725	1725								
	Motor Speed(s)		Adjustable Sheave	Adjustable Sheave	Adjustable Sheave	Adjustable Sheave								
	Bearing Type		Ball	Ball	Ball	Ball								
<b>Exhaust Air Blower</b>	Belt-Drive Motor - hp		1	1-1/2	1-1/2	2								
	Fixed Wheel		1	1-1/2	1-1/2	2								
	Pivoting Wheel		1-1/2	3	3	3								
	Wheel Size (diameter x width) - in		9 x 9	10 x 10	10 x 10	12 x 9								
	Motor Speed - rpm		1725	1725	1725	1725								
	Motor Speed(s)		Adjustable Sheave	Adjustable Sheave	Adjustable Sheave	Adjustable Sheave								
Bearing Type		Ball	Ball	Ball	Ball									
<b>Recovery Wheel</b>	Wheel Depth x Diameter - in		3 x 30-11/32	3 x 37-3/4	3 x 37-3/4	3 x 41-13/16								
	Motor Speed - rpm		1050	825	825	1075								
<b>Electrical Data - Line Voltage - 60Hz</b>			208/230V-3ph, 460V-3ph, or 575V-3ph											
<b>Enthalpy Wheel Airflow Data</b>	Nominal Airflow		1600 cfm at 0.95 in. w.c.	1500 cfm at 0.67 in. w.c.	2600 cfm at 0.95 in. w.c.	3100 cfm at 0.9 in. w.c.								
	EATR - Exhaust Air Transfer Ratio	at minus 1 in. w.c.	7.80%	6.10%	6.10%	4.90%								
		at 0 in. w.c.	0.40%	4.00%	4.00%	1.30%								
		at 1 in. w.c.	0.00%	0.00%	0.00%	0.30%								
	OACF - Outdoor Air Correction Factor	at minus 1 in. w.c.	0.97%	0.98%	0.98%	0.99%								
		at 0 in. w.c.	1.16%	1.13%	1.13%	1.07%								
		at 1 in. w.c.	1.29%	1.23%	1.23%	1.12%								
<b><sup>1</sup>Thermal Ratings at 0 in. w.c. Pressure Differential</b>	Total Effectiveness	100% Airflow Heating	68%	61%	65%	68%	60%	65%	68%	60%	65%	68%	60%	65%
		75% Airflow Heating	72%	67%	71%	74%	67%	71%	74%	67%	71%	74%	67%	71%
		100% Airflow Cooling	68%	61%	64%	68%	60%	63%	68%	60%	63%	68%	60%	63%
		75% Airflow Cooling	72%	67%	70%	74%	67%	70%	74%	67%	70%	74%	67%	70%
	Net Effectiveness	100% Airflow Heating	68%	61%	65%	68%	60%	65%	68%	60%	65%	68%	60%	65%
		75% Airflow Heating	72%	67%	71%	74%	67%	71%	74%	67%	71%	74%	67%	71%
		100% Airflow Cooling	68%	61%	64%	68%	60%	63%	68%	60%	63%	68%	60%	63%
		75% Airflow Cooling	72%	67%	70%	74%	67%	70%	74%	67%	70%	74%	67%	70%
<b><sup>2</sup> Weights</b>	Fixed	Shipping Weight - lbs.	791			811			811			1120		
		Net Weight - lbs.	706			726			726			1045		
	Pivoting	Shipping Weight - lbs.	754			928			928			1125		
		Net Weight - lbs.	669			843			843			1050		

<sup>1</sup> Rated in accordance with AHRI Standard 1060-2011. For further information, please reference AHRI 1060-2011 Standard for Rating Air-to-Air Heat Exchangers For Energy Recovery Ventilation Equipment.

<sup>2</sup> Actual weight may vary and is dependent on configuration.

**SPECIFICATIONS** **13 TO 25 TON MODELS**

<b>General Data</b>	<b>Model Number Fixed Wheel</b>		<b>50R2852xM</b>	<b>50R2852xH</b>	<b>50R3652xH</b>							
	<b>Model Number Pivoting Wheel</b>		<b>50P2852xM</b>	<b>50P2852xH</b>	<b>50P3652xH</b>							
	Nominal Air Volume - cfm		1500-2200	2200-2800	2800-3600							
	Matching Units		Enlight - 156 through 300 models Model L - 156 through 300 models									
<b>Required Height of Rooftop Unit Curb - in.</b>			14	14	24							
<b>Fresh Air Blower</b>	Belt-Drive Motor - hp		1-1/2	1-1/2	2							
	Wheel Size (diameter x width) - in		10 x 10	10 x 10	12 x 9							
	Motor Speed - rpm		1725	1725	1725							
	Motor Speed(s)		Adjustable Sheave	Adjustable Sheave	Adjustable Sheave							
	Bearing Type		Ball	Ball	Ball							
<b>Exhaust Air Blower</b>	Belt-Drive Motor - hp	Fixed Wheel	1-1/2	1-1/2	2							
		Pivoting Wheel	3	3	3							
	Wheel Size (diameter x width) - in		10 x 10	10 x 10	12 x 9							
	Motor Speed - rpm		1725	1725	1725							
	Motor Speed(s)		Adjustable Sheave	Adjustable Sheave	Adjustable Sheave							
	Bearing Type		Ball	Ball	Ball							
	Wheel Depth x Diameter - in		3 x 37-3/4	3 x 37-3/4	3 x 41-13/16							
Motor Speed - rpm		825	825	1075								
<b>Electrical Data - Line Voltage - 60Hz</b>			208/230V-3ph, 460V-3ph, or 575V-3ph									
<b>Enthalpy Wheel Airflow Data</b>	Nominal Airflow		1900 cfm at 0.7 in. w.c.	2600 cfm at 0.95 in. w.c.	3100 cfm at 0.9 in. w.c.							
	EATR - Exhaust Air Transfer Ratio	at minus 1 in. w.c.	6.10%	6.10%	4.90%							
		at 0 in. w.c.	4.00%	4.00%	1.30%							
		at 1 in. w.c.	0.00%	0.00%	0.30%							
	OACF - Outdoor Air Correction Factor	at minus 1 in. w.c.	0.98%	0.98%	0.99%							
		at 0 in. w.c.	1.13%	1.13%	1.07%							
		at 1 in. w.c.	1.23%	1.23%	1.12%							
	<b><sup>1</sup>Thermal Ratings at 0 in. w.c. Pressure Differential</b>	Total Effectiveness	100% Airflow Heating	68%	60%	65%	68%	60%	65%	68%	60%	65%
75% Airflow Heating			74%	67%	71%	74%	67%	71%	74%	67%	71%	
100% Airflow Cooling			68%	60%	63%	68%	60%	63%	68%	60%	63%	
75% Airflow Cooling			74%	67%	70%	74%	67%	70%	74%	67%	70%	
Net Effectiveness		100% Airflow Heating	68%	60%	65%	68%	60%	65%	68%	60%	65%	
		75% Airflow Heating	74%	67%	71%	74%	67%	71%	74%	67%	71%	
		100% Airflow Cooling	68%	60%	63%	68%	60%	63%	68%	60%	63%	
		75% Airflow Cooling	74%	67%	70%	74%	67%	70%	74%	67%	70%	
<b><sup>2</sup>Weights</b>		Fixed	Shipping Weight - lbs.	811			811			1120		
			Net Weight - lbs.	726			726			1045		
		Pivoting	Shipping Weight - lbs.	928			928			1125		
			Net Weight - lbs.	843			843			1050		

<sup>1</sup> Rated in accordance with AHRI Standard 1060-2011. For further information, please reference AHRI 1060-2011 Standard for Rating Air-to-Air Heat Exchangers For Energy Recovery Ventilation Equipment.

<sup>2</sup> Actual weight may vary and is dependent on configuration.

**SPECIFICATIONS**

**13 TO 25 TON MODELS (continued)**

<b>General Data</b>	<b>Model Number Fixed Wheel</b>		<b>50R4652xH</b>	<b>50R6252xM</b>	<b>50R6252xH</b>						
	<b>Model Number Pivoting Wheel</b>		<b>50P4652xH</b>	<b>50P6252xM</b>	<b>50P6252xH</b>						
	Nominal Air Volume - cfm		3400-4600	4800-5600	5500-6200						
	Matching Units		Enlight - 156 through 300 models Model L - 156 through 300 models								
<b>Required Height of Rooftop Unit Curb - in.</b>			24	24	24						
<b>Fresh Air Blower</b>	Belt-Drive Motor - hp		3	5	5						
	Wheel Size (diameter x width) - in		12 x 12	12 x 12	12 x 12						
	Motor Speed - rpm		1725	1725	1725						
	Motor Speed(s)		Adjustable Sheave	Adjustable Sheave	Adjustable Sheave						
	Bearing Type		Ball	Ball	Ball						
<b>Exhaust Air Blower</b>	Belt-Drive Motor - hp	Fixed Wheel	3	5	5						
		Pivoting Wheel	5	2 each - 5	2 each - 5						
	Wheel Size (diameter x width) - in		12 x 12	12 x 12	12 x 12						
	Motor Speed - rpm		1725	1725	1725						
	Motor Speed(s)		Adjustable Sheave	Adjustable Sheave	Adjustable Sheave						
	Bearing Type		Ball	Ball	Ball						
<b>Recovery Wheel</b>	Wheel Depth x Diameter - in		3 x 46-3/4	3 x 52	3 x 52						
	Motor Speed - rpm		1075	1075	1075						
<b>Electrical Data - Line Voltage - 60Hz</b>			208/230V-3ph, 460V-3ph, or 575V-3ph								
<b>Enthalpy Wheel Airflow Data</b>	Nominal Airflow		3900 cfm at 0.95 in. w.c.	5500 cfm at 0.95 in. w.c.	5500 cfm at 0.95 in. w.c.						
	EATR - Exhaust Air Transfer Ratio	at minus 1 in. w.c.	4.40%	4.00%	4.00%						
		at 0 in. w.c.	1.10%	1.00%	1.00%						
		at 1 in. w.c.	0.20%	0.20%	0.20%						
	OACF - Outdoor Air Correction Factor	at minus 1 in. w.c.	0.99%	0.99%	0.99%						
		at 0 in. w.c.	1.06%	1.06%	1.07%						
		at 1 in. w.c.	1.11%	1.10%	1.12%						
<sup>1</sup> <b>Thermal Ratings at 0 in. w.c. Pressure Differential</b>	Total Effectiveness	100% Airflow Heating	Sensible 68%	Latent 60%	Total 65%	Sensible 68%	Latent 60%	Total 65%	Sensible 68%	Latent 60%	Total 65%
		75% Airflow Heating	73%	67%	71%	73%	67%	71%	73%	67%	71%
		100% Airflow Cooling	68%	60%	63%	68%	60%	63%	68%	60%	63%
		75% Airflow Cooling	73%	67%	70%	73%	67%	70%	73%	67%	70%
	Net Effectiveness	100% Airflow Heating	68%	60%	65%	68%	60%	65%	68%	60%	65%
		75% Airflow Heating	73%	67%	71%	73%	67%	71%	73%	67%	71%
		100% Airflow Cooling	68%	60%	63%	68%	60%	63%	68%	60%	63%
		75% Airflow Cooling	73%	67%	70%	73%	67%	70%	73%	67%	70%
<sup>2</sup> <b>Weights</b>	Fixed	Shipping Weight - lbs.	1333			1566			1566		
		Net Weight - lbs.	1224			1441			1441		
	Pivoting	Shipping Weight - lbs.	1339			1623			1623		
		Net Weight - lbs.	1230			1498			1498		

<sup>1</sup>Rated in accordance with AHRI Standard 1060-2011. For further information, please reference AHRI 1060-2011 Standard for Rating Air-to-Air Heat Exchangers For Energy Recovery Ventilation Equipment.

<sup>2</sup> Actual weight may vary and is dependent on configuration.

**SPECIFICATIONS**

**25 AND 30 TON MODELS**

<b>General Data</b>	<b>Model Number Fixed Wheel</b>	<b>50R3653xH</b>	<b>50R4653xH</b>	<b>50R6253xM</b>	<b>50R6253xH</b>										
	<b>Model Number Pivoting Wheel</b>	<b>50P3653xH</b>	<b>50P4653xH</b>	<b>50P6253xM</b>	<b>50P6253xH</b>										
	Nominal Air Volume - cfm	2800-3600	3400-4600	4800-5600	5500-6200										
	Matching Units	Enlight 302 and 360													
<b>Required Height of Rooftop Unit Curb - in.</b>		14	14	14	14										
<b>Fresh Air Blower</b>	Belt-Drive Motor - hp	2	3	5	5										
	Wheel Size (diameter x width) - in	12 x 9	12 x 12	12 x 12	12 x 12										
	Motor Speed - rpm	1725	1725	1725	1725										
	Motor Speed(s)	Adjustable Sheave													
	Bearing Type	Ball													
<b>Exhaust Air Blower</b>	Belt-Drive Motor - hp	Fixed Wheel	2	3	5	5									
		Pivoting Wheel	3	5	2 each - 5	2 each - 5									
	Wheel Size (diameter x width) - in	12 x 9	12 x 12	12 x 12	12 x 12										
	Motor Speed - rpm	1725	1725	1725	1725										
	Motor Speed(s)	Adjustable Sheave													
	Bearing Type	Ball													
<b>Recovery Wheel</b>	Wheel Depth x Diameter - in	3 x 41-13/16	3 x 46-3/4	3 x 52	3 x 52										
	Motor Speed - rpm	1075	1075	1075	1075										
<b>Electrical Data - Line Voltage - 60Hz</b>		208/230V-3ph, 460V-3ph, or 575V-3ph													
<b>Enthalpy Wheel Airflow Data</b>	Nominal Airflow		3100 cfm at 0.9 in w.c.	3900 cfm at 0.95 in. w.c.	5500 cfm at 0.95 in. w.c.	5500 cfm at 0.95 in. w.c.									
	EATR - Exhaust Air Transfer Ratio	at minus 1 in. w.c.	4.90%	4.40%	4.00%	4.00%									
		at 0 in. w.c.	1.30%	1.10%	1.00%	1.00%									
		at 1 in. w.c.	0.30%	0.20%	0.20%	0.20%									
	OACF - Outdoor Air Correction Factor	at minus 1 in. w.c.	0.99%	0.99%	0.99%	0.99%									
		at 0 in. w.c.	1.07%	1.06%	1.06%	1.06%									
		at 1 in. w.c.	1.12%	1.11%	1.10%	1.11%									
	<b><sup>1</sup>Thermal Ratings at 0 in. w.c. Pressure Differential</b>	Total Effectiveness	100% Airflow Heating	68%	61%	65%	68%	60%	65%	68%	60%	65%	68%	60%	65%
75% Airflow Heating			72%	67%	71%	73%	67%	71%	73%	67%	71%	73%	67%	71%	
100% Airflow Cooling			68%	61%	64%	68%	60%	63%	68%	60%	63%	68%	60%	63%	
75% Airflow Cooling			72%	67%	70%	73%	67%	70%	73%	67%	70%	73%	67%	70%	
Net Effectiveness		100% Airflow Heating	68%	61%	65%	68%	60%	65%	68%	60%	65%	68%	60%	65%	
		75% Airflow Heating	72%	67%	71%	73%	67%	71%	73%	67%	71%	73%	67%	71%	
		100% Airflow Cooling	68%	61%	64%	68%	60%	63%	68%	60%	63%	68%	60%	63%	
		75% Airflow Cooling	72%	67%	70%	73%	67%	70%	73%	67%	70%	73%	67%	70%	
<b><sup>2</sup>Weights</b>		Fixed	Shipping Weight - lbs.	1120			1333			1566		1566		1566	
			Net Weight - lbs.	1045			1224			1441		1441		1441	
	Pivoting	Shipping Weight - lbs.	1125			1339			1623		1623		1623		
		Net Weight - lbs.	1050			1230			1498		1498		1498		

<sup>1</sup>Rated in accordance with AHRI Standard 1060-2011. For further information, please reference AHRI 1060-2011 Standard for Rating Air-to-Air Heat Exchangers For Energy Recovery Ventilation Equipment.

<sup>2</sup> Actual weight may vary and is dependent on configuration.



## ELECTRICAL DATA

Model No.		<sup>1</sup> 50R0649xH	50R1149xH 50P1149xH	50R2049xH 50R2051xH	50P2049xH 50P2051xH	50R2851xM 50R2852xM 50R2851xH 50R2852xH	50P2851xM 50P2852xM 50P2851xH 50P2852xH
<b>Fresh Air Blower Motor</b>	115V-1ph	3.8	---	---	---	---	---
	208/230V-3ph	---	3.4	3.8	3.8	5.6	5.6
	460V-3ph	---	1.4	1.9	1.9	2.8	2.8
	575V-3ph	---	1.4	1.4	1.4	2	2
<b>Exhaust Blower Motor</b>	115V-1ph	3.8	---	---	---	---	---
	208/230V-3ph	---	3.4	3.8	5.6	5.6	9
	460V-3ph	---	1.4	1.9	2.8	2.8	4.4
	575V-3ph	---	1.4	1.4	2.0	2.0	3.6
<b>Wheel Drive Motor - Full load amps</b>		0.7	0.3	0.3	0.3	0.6	0.6
<b>Maximum Overcurrent Protection (amps)</b>	115V-1ph	10	---	---	---	---	---
	208/230V-3ph	9	10	12	15	20	25
	460V-3ph	4	6	6	8	10	12
	575V-3ph	3	6	5	6	7	10
<sup>1</sup> <b>Minimum Circuit Ampacity</b>	115V-1ph	9.3	---	---	---	---	---
	208/230V-3ph	5.4	8	8.9	11.1	13.2	17.5
	460V-3ph	2.7	3.5	4.6	5.7	6.9	8.9
	575V-3ph	2.2	3.5	3.5	4.2	5.1	7.1

## ELECTRICAL DATA

Model No.		50R3651xH 50R3652xH	50P3651xH 50P3652xH	50R4652xH	50P4652xH	50R6252xM 50R6252xH	50P6252xM 50P6252xH
<b>Fresh Air Blower Motor</b>	208/230V-3ph	7	7	9	9	15	15
	460V-3ph	3.5	3.5	4.4	4.4	7.4	7.4
	575V-3ph	2.4	2.4	3.6	3.6	5.9	5.9
<b>Exhaust Blower Motor</b>	208/230V-3ph	7	9.4	9	15.3	15.3	15.3
	460V-3ph	3.5	4.3	4.3	6.4	6.4	6.4
	575V-3ph	2.4	3.2	3.4	5.1	5.1	5.1
<b>Wheel Drive Motor - Full load amps</b>		1.2	1.2	1.2	1.2	1.2	1.2
<b>Maximum Overcurrent Protection (amps)</b>	208/230V-3ph	25	25	30	40	50	50
	460V-3ph	12	15	15	20	25	25
	575V-3ph	10	12	12	15	20	20
<sup>1</sup> <b>Minimum Circuit Ampacity</b>	208/230V-3ph	17	20	21.5	29.4	35.4	35.4
	460V-3ph	9	10	11	13.6	16.9	16.9
	575V-3ph	6.6	7.6	9.1	11.2	13.7	13.7

## ELECTRICAL DATA - 60 Hz

Model No.		50R3653XH	50P3653xH	50R4653xH	50P4653xH	50R6253xM 50R6253xH	50P6253xM 50P6253xH
<b>Fresh Air Blower Motor</b>	208/230V-3ph	7	7	9	9	15	15
	460V-3ph	3.5	3.5	4.4	4.4	7.4	7.4
	575V-3ph	2.4	2.4	3.6	3.6	5.9	5.9
<b>Exhaust Blower Motor</b>	208/230V-3ph	7	9.4	9	15.3	15.3	15.3
	460V-3ph	3.5	4.3	4.3	6.4	6.4	6.4
	575V-3ph	2.4	3.2	3.4	5.1	5.1	5.1
<b>Wheel Drive Motor - Full load amps</b>		1.2	1.2	1.2	1.2	1.2	1.2
<b>Maximum Overcurrent Protection (amps)</b>	208/230V-3ph	25	25	30	40	50	50
	460V-3ph	12	15	15	20	25	25
	575V-3ph	10	12	12	15	20	20
<sup>1</sup> <b>Minimum Circuit Ampacity</b>	208/230V-3ph	17	20	21.5	29.4	35.4	35.4
	460V-3ph	9	10	11	13.6	16.9	16.9
	575V-3ph	6.6	7.6	9.1	11.2	13.7	13.7

NOTE - Refer to National or Canadian Electrical Code manual to determine wire, fuse and disconnect size requirements.

<sup>1</sup> A unit step-down transformer is provided, 208/230/460/575V primary, 120V secondary.

## DIMENSIONS

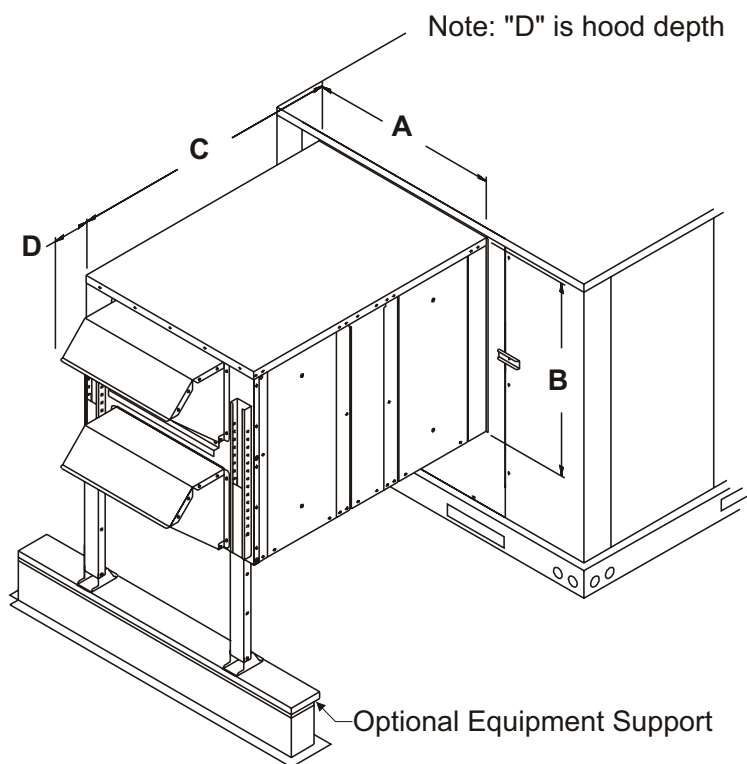

Model No.	Usage	A	B	C	D
50R0649xH 50P0649xH	024-072	24-3/4 (629)	24-5/8 (625)	34-9/16 (876)	8 (203)
50R1149xH 50P1149xH		32-1/8 (816)	33-1/2 (851)	44-3/4 (1138)	11 (279)
50R2049xH 50P2049xH	072	37-1/4 (946)	37-1/2 (953)	54-3/8 (1381)	20-5/16 (516)
50R2051xH 50P2051xH	092-150				
50R2851xM 50P2851xH 50R2851xM 50P2851xH	092-150	42-5/8 (1083)	43-9/16 (1106)	52-1/4 (1327)	18-5/16 (465)
50R3651xH 50P3651xH		46-11/16 (1186)	57-3/8 (1457)	60 (1524)	18-5/16 (465)

Model No.	Usage	A	B	C	D	
50R2852xM 50R2852xH 50P2852xM 50P2852xH	156-300	42-5/8 (1083)	43-9/16 (1106)	52-1/4 (1327)	18-5/16 (465)	
50R3652xH 50P3652xH		46-11/16 (1186)	57-3/8 (1457)	60 (1524)	18-5/16 (465)	
50R4652xH 50P4652xH		52-11/16 (1338)	57-3/8 (1457)	60 (1524)	18-5/16 (465)	
50R6252xM 50R6252xH 50P6252xM 50P6252xH		58-7/8 (1496)	57-3/8 (1457)	60 (1524)	18-5/16 (465)	
50R3653xH 50P3653xH		302-360	46-11/16 (1186)	57-3/8 (1457)	60 (1524)	18-5/16 (465)
50R4653xH 50P4653xH			52-11/16 (1338)	57-3/8 (1457)	60 (1524)	18-5/16 (465)
50R6253xM 50R6253xH 50P6253xM 50P6253xH	58-7/8 (1496)		57-3/8 (1457)	60 (1524)	18-5/16 (465)	

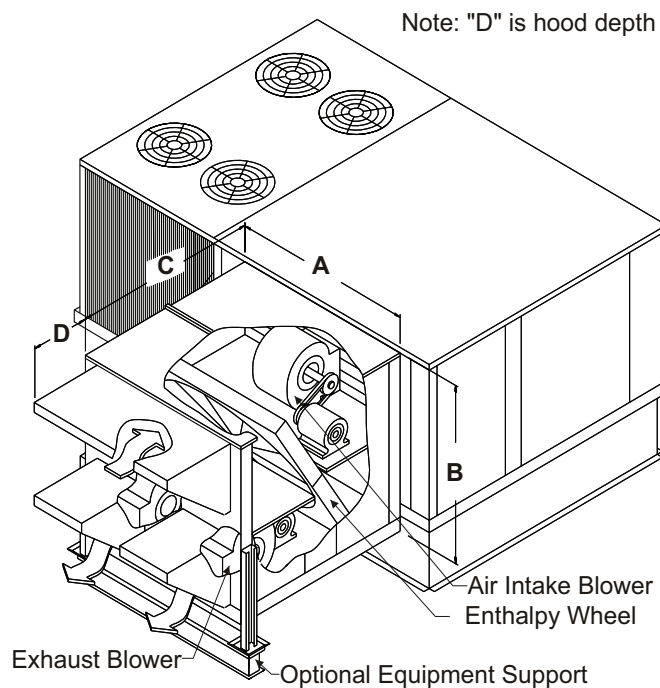

# UNIT CLEARANCES

## 2 TO 6 TON

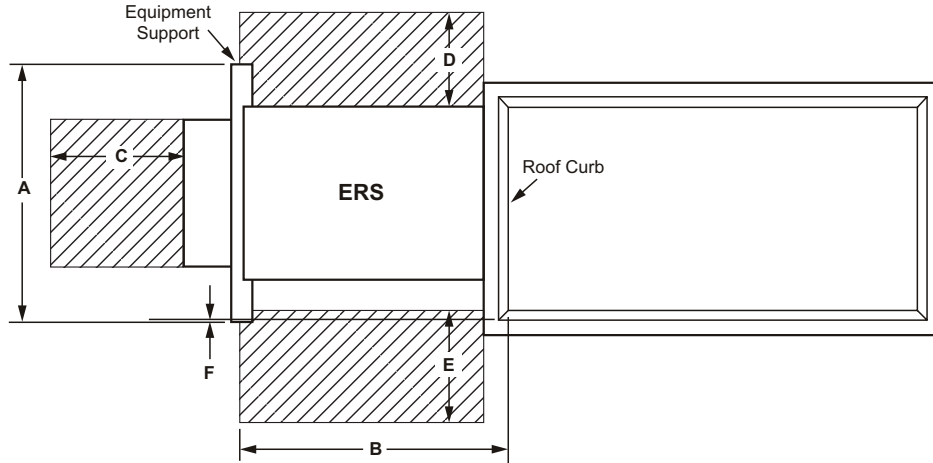

## 6.5 TO 12.5 TON

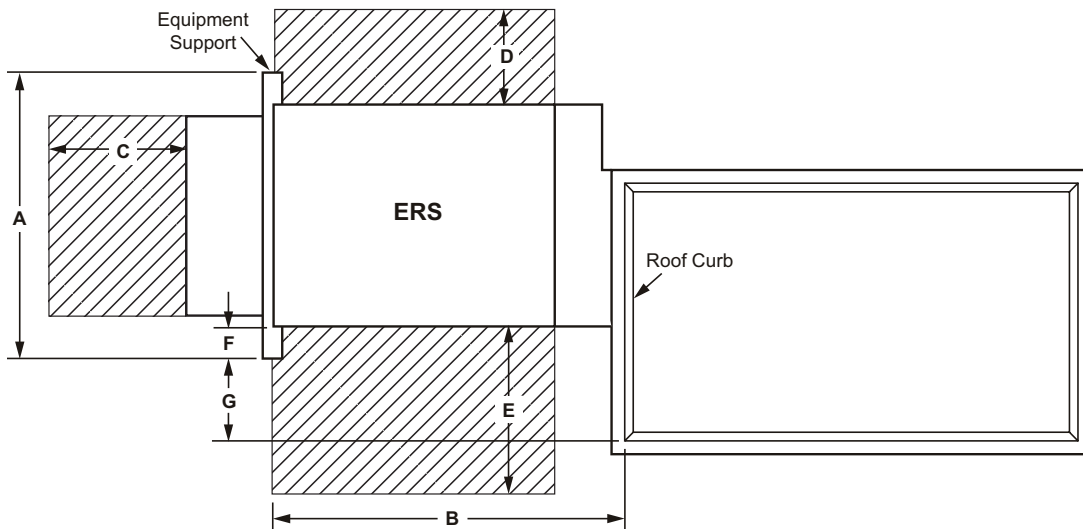

ERS Model No.	A		B		C		D		E		F		G	
	in.	mm	in.	mm	in.	mm	in.	mm	in.	mm	in.	mm	in.	mm
<b>024-072 Models</b>														
50R0649xH	48	1219	39-3/8	1000	16	406	18	457	24	610	2	51	---	---
50R1149xH 50P1149xH	48	1219	49-1/2	1257	24	610	18	457	36	914	2	51	---	---
<b>072 Models</b>														
50R2049xH 50P2049xH	48	1219	58-1/4	1480	40	1016	24	610	42	1067	2	51	---	---
<b>078-150 Models</b>														
50R2051xH 50P2051xH	48	1219	60-3/8	1533	40	1016	24	610	42	1067	5-3/8	137	18-5/8	473
50R2851xM 50P2851xH 50P2851xM	60	1524	66-1/4	1683	36	914	24	610	48	1219	6-5/8	168	17-1/2	444
50R3651xH 50P3651xH	60	1524	74	1880	36	914	30	762	60	1524	6-5/8	168	17-1/2	444

**UNIT CLEARANCES**

13 TO 25 TON

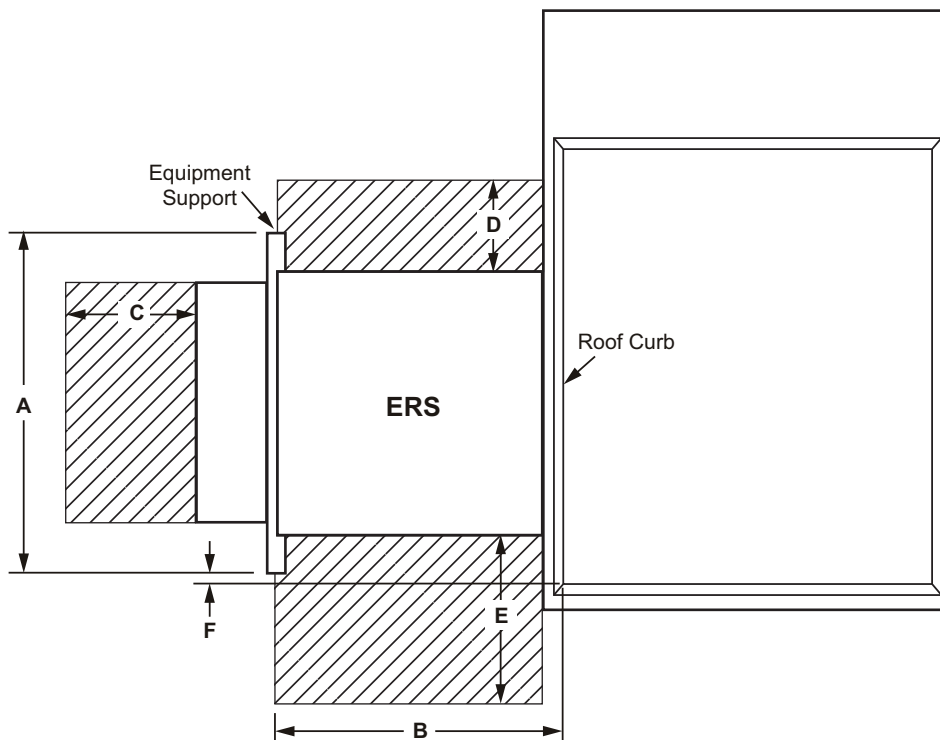

ERS Model No.	A		B		C		D		E		F	
	in.	mm	in.	mm	in.	mm	in.	mm	in.	mm	in.	mm
<b>Energence 156-300</b>												
50R2852xM 50R2852xH 50P2852xM 50P2852xH	60	1524	56-1/8	1426	36	914	24	610	48	1219	11-1/4	286
50R3652xH 50P3652xH	60	1524	56-1/8	1426	36	914	24	610	48	1219	11-1/4	286
50R4652xH 50P4652xH	76	1930	63-7/8	1622	36	914	30	762	60	1524	3-1/8	79
50R6252xM 50R6252xH 50P6252xM 50P6252xH	76	1930	63-7/8	1622	36	914	30	762	60	1524	3-1/8	79
<b>Energence 302 and 360</b>												
50R2051xH 50P2051xH	60	1524	63-7/8	1622	36	914	30	762	60	1524	11-1/4	286
50R2851xM 50R2851xH 50P2851xM 50P2851xH	76	1930	63-7/8	1622	36	914	30	762	60	1524	3-1/8	79
50R3651xH 50P3651xH	76	1930	63-7/8	1622	36	914	30	762	60	1524	3-1/8	79

## GUIDE SPECIFICATIONS

Prepared for the guidance of architects, consulting engineers and mechanical contractors.

### General

- Unit shall be a constant volume, energy recovery system used in conjunction with packaged rooftop equipment
- Unit shall be directly coupled to the rooftop packaged unit to form a unitized system
- Unit shall be performance rated in accordance with AHRI standards and in compliance with ASHRAE or DOE standards
- Unit shall be certified to the applicable safety standards for the installed country
- In addition, manufacturer shall test operate system at the factory before shipment

### Approval

- All models shall be certified in accordance with AHRI Standard 1060-2023, Air-to-Air Energy Recovery Ventilation Equipment and Standard for Safety for Heating and Cooling Equipment ANSI/UL1995, CAN CSA - 22.2 No. 236-05

### Equipment Warranty

- Energy Recovery wheel shall have a limited warranty for five years
- All other covered components have a limited warranty for one year

### Cabinet

- Shall be designed to attach directly to the rooftop unit.
- Shall be constructed of G90 galvanized steel with a powdered enamel paint finish electro-statically bonded to the metal
- Metal shall be salt spray tested for 1000 hours per ASTM B-117
- Cabinet panels shall be fully insulated with non-hygroscopic fiberglass insulation. Insulation shall have an R-Value of 3.7 and shall be flame resistant per UL-723. Insulation shall be in accordance with NFPA 90A and tested to meet UL 181 erosion requirements
- Full perimeter base rail with top mounted rigging holes and fork truck access from three sides shall be provided
- Test ports shall be provided so airflow can be measured across the energy recovery wheel

### Energy Recovery Wheel Types

- Wheel shall be either of the enthalpy type for both sensible and latent heat recovery or the sensible type for sensible heat recovery
- Energy transfer ratings shall be certified in accordance with AHRI Standard 1060-2023.
- Wheel shall be constructed of a lightweight polymer material
- Enthalpy type shall be coated with a desiccant silica gel that will not dissolve or liquefy in the presence of water or high humidity
- All energy recovery wheels shall be designed to be removed from the unit for ease of inspection and maintenance, 25 inch and larger wheels shall be segmented for easy removal
- The wheel shall be easily cleanable with standard coil cleaning solution
- The wheel shall be available in both fixed and pivoting configurations

### Performance

- The complete line of units shall have a cfm range of 300 to 6200
- Individual units shall be available in ranges of 300-550, 700-1000, 1000-1700, 1500-2200, 2200-2800, 2800-3600, 3400-4600, 4800-5600, and 5500-6200 cfm
- Unit shall operate to 10oF without the need for frost protection
- Unit shall have up to 73% net effectiveness per AHRI tests. Application effectiveness shall be higher

### Control Operation

- Operation shall be controlled by a low voltage logic board
- Logic board shall control low ambient kit and motorized outside air damper

### Access Doors

- All components shall be accessible through removable access doors as a standard option

### Filters

- All unit shall be provided with mist eliminator type filters in the intake air hood
- Optional internal MERV 8 pleated filters provided with filter racks

### Blowers

- Intake/exhaust air blowers shall be direct drive on ERS of 1000 cfm or less
- Belt drive intake/exhaust air blowers shall be used on ERS over 1000 cfm

## GUIDE SPECIFICATIONS

### Motors

- Blower motors on belt drive ERS shall have permanently lubricated ball bearings. Motors shall have thermal overload protection and shall have adjustable sheaves for blower speed adjustment.
- Blower motors on direct drive ERS shall be PSC type with multiple speeds.
- Intake and exhaust motors shall be individually controlled.
- Motor efficiency shall meet requirements of U.S. Energy Policy Act of 1992 (EPACT).

### Electrical

- Units shall have single power point connection.
- A low voltage terminal strip shall be available.

### Balancing Dampers

- Shall be provided for all fixed wheel units and shall be mounted inside the rooftop unit.

### Barometric Relief Dampers

- Pressure operated dampers shall be provided for all ERS units.

## Options / Accessories

### Low Ambient Kit

- Low Ambient Kit shall be factory installed to prevent frost formation on the energy recovery wheel.
- Frost is prevented controlling the intake blower operation when discharge temperature is below a selectable temperature setting.

### Motorized Outside Air Damper Assembly with Hood

- Shall be factory installed to provide motorized operation of intake air requirements.
- Damper assembly shall be installed behind the ERS outside air intake hood.

### Motorized Exhaust Air Damper

- Shall be factory installed to provide motorized operation of exhaust air requirements.
- Damper assembly shall be install in the ERS barometric relief hood.

### Stop-Start-Jog

- Shall be a factory installed option for fixed wheel units only. Matching rooftop unit should not have an economizer.

### Pressure Sensor

- Shall be a factory installed option to provide the amount of outside airflow across the enthalpy wheel.

### Rotation Sensor

- Shall be a factory installed option to verifies the rotation of the enthalpy wheel.

### Disconnect

- Shall be factory installed and field wired to provide easy ability to turn power on/off to the ERS

### VFD

- Shall be factory installed to provide variable frequency drive to control the speed of the blowers only.

### Dirty Filter Sensor

- Shall be factory installed to provide a sensor to signal a field installed alarm when the filters need to be cleaned or changed.

### Filter Rack

- Shall be factory installed with 2" MERV 8 pleated filters to filter air in both the intake and exhaust sections of the ERS.

### Optional Energy Recovery Wheel

- Optional wheel shall be the sensible type for sensible heat recovery.
- Energy transfer ratings shall be certified in accordance with AHRI Standard 1060-2023.
- Wheel shall be constructed of a lightweight polymer material.
- All energy recovery wheels shall be designed to be removed from the unit for ease of inspection and maintenance, 25 inch (635 mm) and larger wheels shall be segmented for easy removal.
- The wheel shall be easily cleanable with standard coil cleaning solution.
- The wheel shall be available in both fixed and pivoting configurations.

### GFI Service Outlet

- Shall be field installed and field wired to provide powered service outlet.

### ERS Equipment Support

- Shall be field installed to provide support of the exhaust and intake end of the ERS.
- Supports are available in 48, 60, and 76 inch (1219, 1524 and 1930 mm) lengths.

### ERS Roof Curb

- Shall be field installed to provide support of the RTU and raise them to the correct height for mounting.

**OPTIONS / ACCESSORIES - ORDER SEPARATELY**

Model No.	Fixed Wheel	50R0649xH 50R1149xH 50R2049xH	50R2051xH	50R2851xM 50R2851xH	50R2852xM 50R2852xH	50R3651xH	50R3652xH	50R4652xH	50R6252xM 50R6252xH
	Pivot Wheel	50P1149xH <sup>2</sup> 50P2049xH	50P2051xH	50P2851xM 50P2851xH	50P2852xM 50P2852xH	50P3651xH	50P3652xH	50P4652xH	50P6252xM 50P6252xH
Dirty Filter Sensor		○	○	○	○	○	○	○	○
<sup>3</sup> Disconnect		○	○	○	○	○	○	○	○
Energy Recovery Wheel - Sensible		○	○	○	○	○	○	○	○
Filter Rack		○	○	○	○	○	○	○	○
<sup>3</sup> GFI Service Outlet		X	X	X	X	X	X	X	X
Low Ambient Kit		○	○	○	○	○	○	○	○
Motorized Exhaust Air Damper Kit		○	○	○	○	○	○	○	○
Motorized Outdoor Air Damper Kit		○	○	○	○	○	○	○	○
Pressure Sensor Kit		○	○	○	○	○	○	○	○
<sup>1</sup> Stop-Start-Jog Kit		○	○	○	○	○	○	○	○
Roof Curb	502014414	X							
	502014714		X	X					
	502014724					X			
	502013214				X				
	502013224						X	X	X
Equipment Support	012104808	X	X						
	012106008			X	X	X	X		
	012107608							X	X
Rotation Sensor		○	○	○	○	○	○	○	○
VFD		○	○	○	○	○	○	○	○

**OPTIONS / ACCESSORIES - ORDER SEPARATELY**

Model No.	Fixed Wheel	50R3653xH	50R4653xH	50R6253xM 50R6253xH
	Pivot Wheel	50P3653xH	50P4653xH	50P6253xM 50P6253xH
Dirty Filter Sensor		○	○	○
<sup>3</sup> Disconnect		○	○	○
Energy Recovery Wheel - Sensible		○	○	○
Filter Rack		○	○	○
<sup>3</sup> GFI Service Outlet		X	X	X
Low Ambient Kit		○	○	○
Motorized Exhaust Air Damper Kit		○	○	○
Motorized Outdoor Air Damper Kit		○	○	○
Pressure Sensor Kit		○	○	○
<sup>1</sup> Stop-Start-Jog Kit		○	○	○
Roof Curb	502014414	X		
Equipment Support	012104808	X	X	X
	012106008		X	X
Rotation Sensor		○	○	○
VFD		○	○	○

○ - Configure to Order (Factory Installed)

X - Field Installed.

<sup>1</sup> Available on Fixed Wheel models only.

<sup>2</sup> Available for 6 ton models only.

<sup>3</sup> Must be field wired.

## REVISIONS

Sections	Description of Change
Document	Added specifications and dimensions for Enlight 302-360 models.



Visit us at [www.Lennox.com](http://www.Lennox.com)

For the latest technical information, [www.LennoxCommercial.com](http://www.LennoxCommercial.com)

Contact us at 1-800-4-LENNOX

NOTE - Due to Lennox' ongoing commitment to quality, Specifications, Ratings and Dimensions subject to change without notice and without incurring liability. Improper installation, adjustment, alteration, service or maintenance can cause property damage or personal injury. Installation and service must be performed by a qualified installer and servicing agency.

©2025 Lennox Industries, Inc.