



**RESIDENTIAL / COMMERCIAL
PRODUCT SPECIFICATIONS**

Bulletin No. 211045
April 2024
Supersedes all previous versions



MCFA/MCFB Ceiling/Floor Mount Indoor Unit
with Furnished Wireless Remote Controller

Nominal Capacity - 1.5 to 4 Tons

MODEL NUMBER IDENTIFICATION

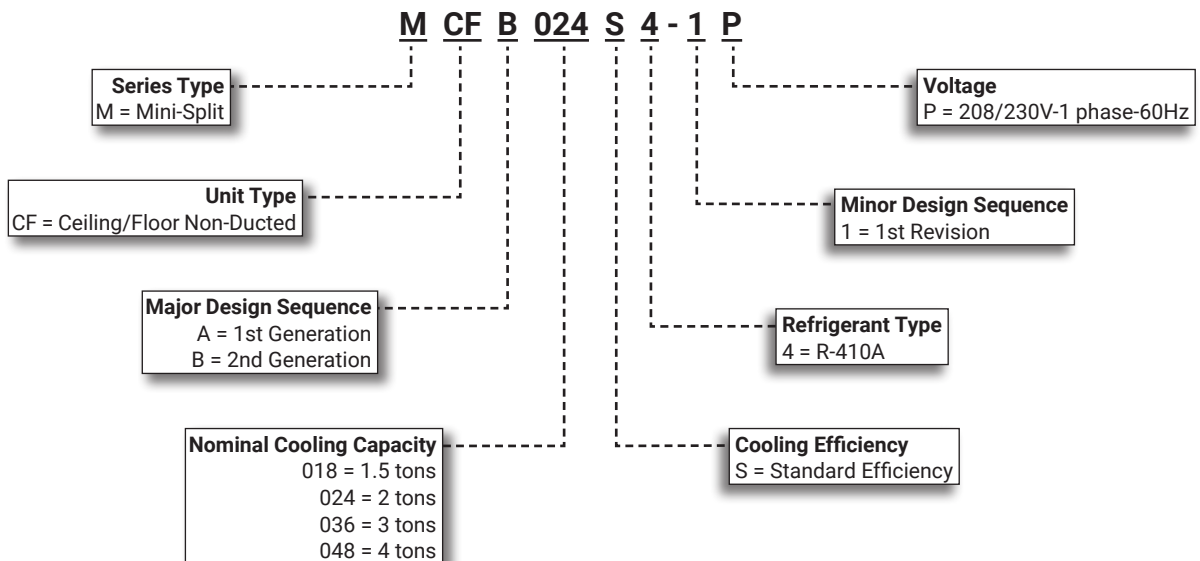

CONTENTS

Air Throw Data	11
Approvals And Warranty	2
Dimensions	13
Features	2
Installation Clearances	14
Model Number Identification.	1
Optional Accessories - Order Separately	10
Remote Controller - Furnished	3
Remote Controllers - Optional	6
Sound Levels - Test Conditions	12
Specifications	10

APPROVALS AND WARRANTY

APPROVALS

- Indoor units and components UL and CEC bonded for grounding to meet safety standards for servicing

WARRANTY

- All covered components
 - Limited five years in all applications
- Accessories and controls - Limited one year

NOTE - Refer to Lennox Basic Limited Warranty at www.Lennox.com for additional details.

FEATURES

- Low-sound, three-speed Ceiling and Floor Mount models with LED display has a multi-blade fan that distributes air vertically and horizontally with a wide angle sweeping motion
- Two installation options are available:
 1. Horizontally against the ceiling
 2. Vertically against the floor/wall
- **Pre-Heat Function** - Delays the operation of the fan until the indoor coil has reached a pre-determined temperature which prevents the discharge of cold air while the system is operating in the "heating" mode
- **LED Readout/Infrared Receiver Panel** - Mounted on unit. LEDs display unit operation status, and codes for maintenance and servicing
- Infrared receiver for use with wireless remote controller (furnished)



NOTE - Readout panel design varies depending on unit size.

- **Auto Restart** - Automatically restores the previous function setting if power is interrupted
- **Cooling Override** - Button on the indoor unit allows a temporary 30 minute override of the system for forced "AUTO" or "COOLING" operation
- **Flare Connections** - Equipped with liquid and gas flare fittings for quick and secure piping

- **Multi-Refrigerant Outlet** - Allows left, right, or rear access for refrigeration line connection
- **Three Speed Fan** - Fan functions at three speeds: low, medium and high
- **Air Filter** - Cleanable air filter is furnished as standard
- **Wireless Remote Controller** - Furnished as standard, see Page 3

OPTIONAL ACCESSORIES

Condensate Pumps

- Quietly and efficiently removes condensate
- See Optional Accessories Table for available pumps

A/C Easy Tee® Condensate Cleanout

- Condensate drain service port
- Flexible and easy to use with nitrogen, water or shop vac
- Screw cap on top allows easy access to condensate drain line

Wired Remote Controllers

- Programmable controller available, see Page 6
- Non-programmable controller available, see Page 8

REMOTE CONTROLLER - FURNISHED

WIRELESS REMOTE CONTROLLER (RG10B-DCFC)

- Complete remote control of system
- Maximum operating range is 25 ft.
- Operates on two AAA 1.5V batteries (furnished)
- Wireless remote controller holder furnished
- Holder can be mounted on a wall for easy access
- Mounting screws furnished

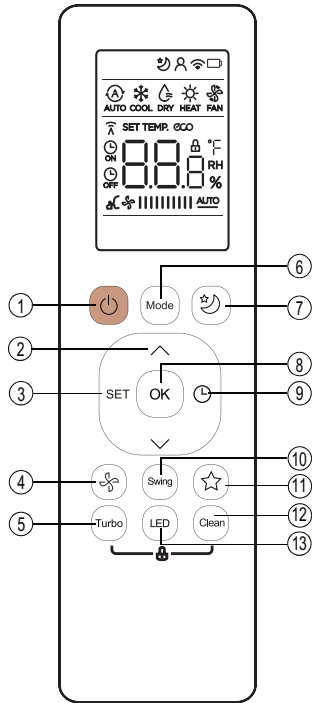

1 ON/OFF Button

- Turns system on and off

2 UP/DOWN Buttons ^ v

- Increase or decrease the indoor temperature in one degree increments (maximum 86°F, minimum 62°F)

NOTE - Temperature cannot be adjusted in FAN mode.

NOTE - Press and hold and buttons together for 3 seconds to alternate the temperature display between the °C and °F scale.

3 SET Button

- Scrolls through unit operations in this order:

1. Follow Me 

NOTE - The selected symbol will flash on the display area. Press the OK button to confirm.

4 FAN Button

- Cycles fan speeds in the following order:

• AUTO → LOW → MED → HIGH

NOTE - Holding Fan button down for 2 seconds will activate **Silence** feature.

5 TURBO Button

- Enables the unit to reach the preset temperature during cooling or heating operation in the shortest time

6 MODE Button

- Select system operation modes
- Press button to cycle through each setting:
 - AUTO → COOL → DRY → HEAT → FAN

7 SLEEP Button

Sleep

- Enables the system to automatically increase cooling or decrease heating (in 2°F increments) per hour for the first 2 hours, then maintain a steady temperature for 5 hours
- System keeps the final operation mode after 8 total hours of operation

8 OK Button

- Confirms selected function

9 TIMER Button

- Initiates an auto-on or auto-off time sequence
- Press TIMER button to initiate the ON time sequence
- Press Temp. up or down button for multiple times to set the desired time to turn on the unit
- Press TIMER button to initiate the OFF time sequence.

NOTE - Each press of the button increases or decreases the time (depending on function) in 30 minute increments up to 10 hours.

Above 10 hours each press of the button will increase or decrease the auto-timed setting by 60 minutes up to 24 hours.

To cancel, set timer to 0.0 or turn remote off and on.

10 SWING Button

- Used to stop or start louver auto swing feature

11 SHORTCUT Button

- Restore the current settings or resume the previous settings

12 CLEAN Button

- Start/stop the Self-Clean function
- Unit cleans itself automatically

NOTE - Only available in COOL or DRY modes.

NOTE - Not for MCFA036-048 and MMDB036-048 models.

13 LED Button

- Turns the LCD display backlight on the indoor unit on or off

NOTE - Press and hold the button for 5 seconds to display the actual room temperature. Press more than 5 seconds to revert back to display set temperature.

REMOTE CONTROLLER - FURNISHED

WIRELESS REMOTE CONTROLLER INDICATORS (RG10B-DCFC)

Information is displayed when the Wireless Remote Controller is powered on.

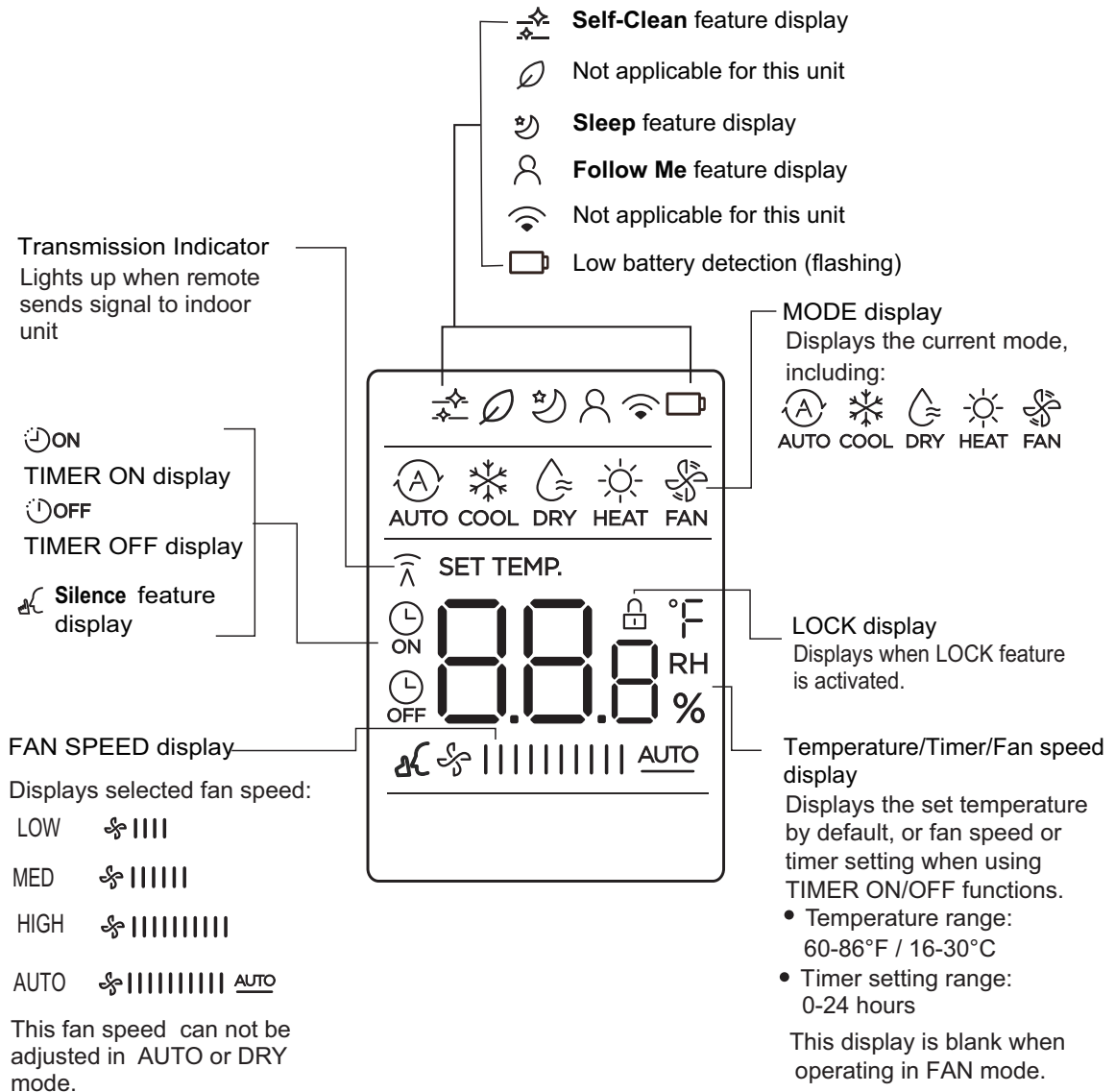

Note:
All icons are shown for display purposes only.
During actual unit operation, only active icons are displayed.

REMOTE CONTROLLER - FURNISHED

WIRELESS REMOTE CONTROLLER OPERATION (RG10B-DCFC)

Auto Operation

1. Press the **MODE** button to select Auto.
2. Press the **UP/DOWN** button to set the desired temperature.
3. Press the **ON/OFF** button to start the system.

Cooling /Heating/Fan Operation

1. Press the **MODE** button to select **COOL, HEAT** or **FAN** mode.
2. Press the **UP/DOWN** buttons to set the desired temperature.
3. Press the **FAN** button to select the fan speed in four steps- Auto, Low, Med or High.
4. Press the **ON/OFF** button to start the system.

Dehumidifying (DRY) Operation

1. Press the **MODE** button to select **DRY** mode.
2. Press the **UP/DOWN** buttons to set the desired temperature.
3. Press the **ON/OFF** button to start the system.

NOTE - Fan speed selection is disabled.

Timer ON/OFF Operation

1. Press the **TIMER** button. The remote controller shows **TIMER ON** or **TIMER OFF** icon
2. Press the **TIMER** button again to set desired time. Each time the button is pressed the time increases by 30 minutes between 0 and 10 hours and then by 60 minutes between 10 and 24 hours.
3. After setting the **TIMER ON** or **TIMER OFF** there will be a one second delay before the remote controller transmits the signal to the unit. After approximately 2 seconds the set temperature will re-appear on the LCD display window.

Silence Operation

1. Press the **FAN** button for more than 2 seconds to activate or disable the Silence function

Lock Function

1. Press the **TURBO** and **HUMIDITY** buttons together two times in less than one second to lock the Controller to prevent tampering
2. Press the **TURBO** and **HUMIDITY** together buttons again for two seconds to unlock the Controller

Swing Function

1. Press the **Swing** button to activate parallel louver operation. Louvers oscillate up and down automatically. Press and hold the Swing button again to disable.

NOTE - Pressing the Swing button multiple times will set the louvers at five different fixed airflow angles.

2. Press **Swing** button for 2 seconds to activate upright louver operation. Louvers swing left and right automatically.

SET BUTTON FUNCTIONS

Follow Me

- Allows remote temperature sensing of the room at the remote controller location

REMOTE CONTROLLERS - OPTIONAL

WIRED REMOTE CONTROLLER (M0STAT120L-1)



FEATURES

- Built-In Memory - Maintains clock, fan speed and mode of operation settings following power outages
- Dimensions (H x W x D) - 4-3/4 x 4-3/4 x 7/8 in.
- Additional hardware is furnished for installation
- 3-1/2 in. back-lit LCD display screen
- Wiring - Controller uses 5-wire shielded 20 ft. cable (furnished) for easy low voltage connection to the indoor unit
- Maximum cable length is 59 ft.

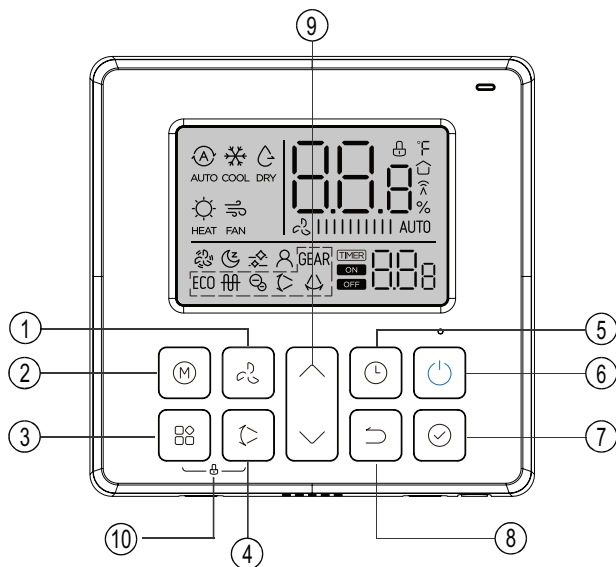

1 FAN SPEED Button

- Selects fan speed. Each button press cycles through the following settings on display

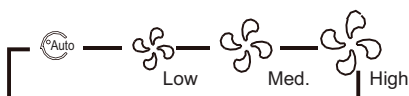

2 MODE Button

- Select system operation modes. Push button to cycle through each setting

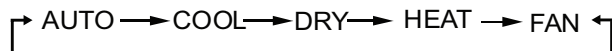

3 FUNCTION Button

- Scrolls through unit operations in this order:

1. Turbo
2. Sleep
3. Active Clean
4. Follow Me

4 SWING Button

- Used to stop or start louver auto swing feature (certain models)
- Louvers oscillate up and down automatically. Press and hold the Swing button again to disable.
- Pressing the Swing button multiple times will set the louvers at five different fixed airflow angles.
- Press and hold Swing button for 2 seconds to activate left/right louver operation. Louvers swing left and right automatically.

5 TIMER Button

- TIMER ON (initiates an auto-on time sequence)
- TIMER OFF (initiates an auto-off time sequence) can be used separately or together
- Each press of the button increases the time in 30 minute increments up to 10 hours
- Above 10 hours each press of the button will increase the auto-timed setting by 60 minutes up to 24 hours

6 POWER Button

- Turns system on and off

7 CONFIRM Button

- Confirms selected function

NOTE - Press and hold and **Arrow Up** Button and the **Arrow Down** button together for 3 seconds to alternate the temperature display between the °F and °C scale.

8 BACK Button

- Returns to the previous step

9 UP/DOWN Buttons

- Increase or decrease the indoor temperature in two degree increments (maximum 86°F, minimum 60°F).

NOTE - Temperature cannot be adjusted in FAN mode.

10 LOCK

- Press the **Function** and **Swing** buttons simultaneously to lock or unlock the Controller to prevent tampering with settings

OPTIONAL ACCESSORIES

Extension Cable for Wired Remote Controller

- 20 ft. cable for easy low voltage connection to the indoor unit
- Extends cable to maximum 65 ft. length

REMOTE CONTROLLERS - OPTIONAL

WIRED REMOTE CONTROLLER INDICATORS (M0STAT120L-1)

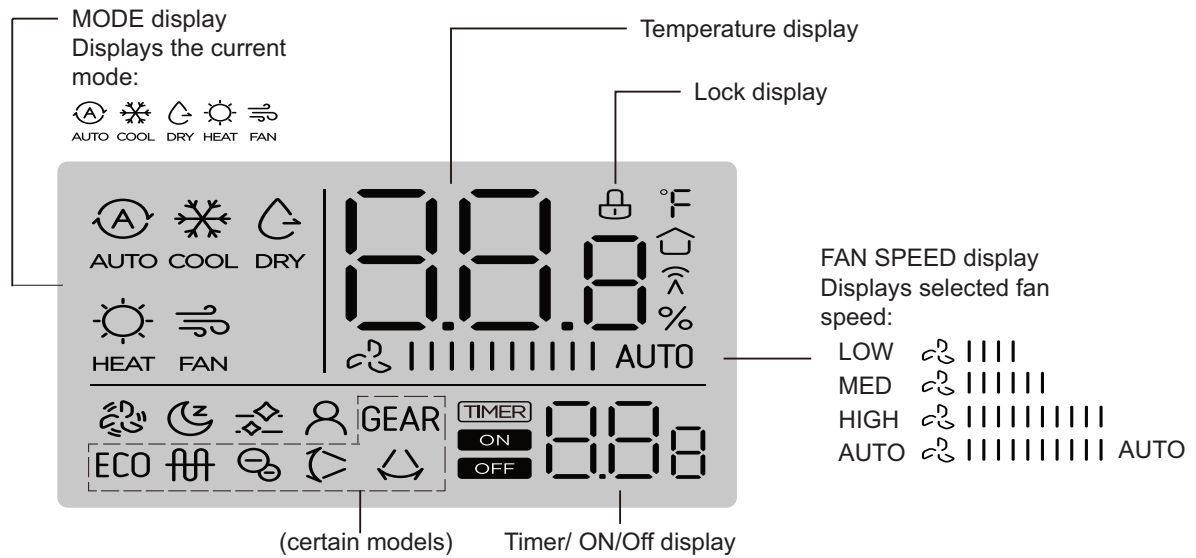

°F	°F / °C display	(Turbo icon)	Turbo feature display	GEAR	GEAR feature display (certain models)
(Room icon)	Room temperature display	(Active Clean icon)	Active clean display	ECO	ECO feature display (on certain models)
(Person icon)	Follow me feature display	(Sleep icon)	SLEEP feature display	(Electric Heating icon)	Electric heating display (certain models)
(Not used icon)	Not used	(Swing icon)	UP and down swing (certain models)	(Left/Right Swing icon)	Left and right swing (certain models)

NOTE:
 All icons are shown for display purposes only.
 During actual unit operation, only active icons are displayed.

REMOTE CONTROLLERS - OPTIONAL

WIRED PROGRAMMABLE CONTROLLER (M0STAT120N-1)



FEATURES

- Wired programmable local controller for mini-split indoor units with convenient timed schedules for daily operation
- Weekly timers (2), all days of the week timer, up to 8 scheduled events per day
- Schedule start time, mode, setpoint, and fan speed
- Compatible with all indoor units
- Copy/paste function for easy duplication of events to other days
- Built-in system diagnostics
- 3-1/2 in. back-lit LCD display screen
- Controller uses 4-wire shielded 20 ft. cable (furnished) for easy low voltage connection to the indoor unit
- Adaptor cables are furnished for various indoor unit connections

NOTE - Cable for longer lengths must be ordered separately.

NOTE - Maximum cable length is 164 ft..

- Hardware for mounting furnished
- Mounts to standard electrical junction box (not furnished)
- Lithium battery furnished: CR2032
- Power Supply: 12 VDC
- Dimensions (H x W x D): 4-3/4 x 4-3/4 x 7/8 in.
- Audible tone when a button is pressed (can be disabled)
- Lock function disables buttons to prevent tampering

DISPLAY

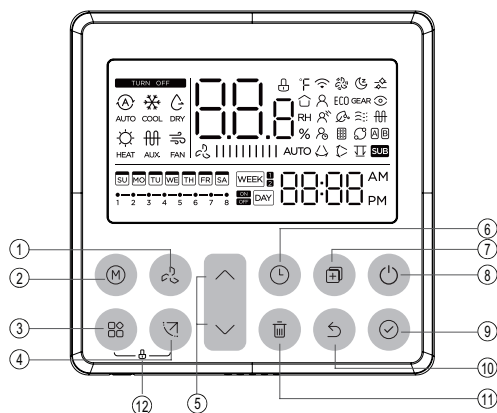

BUTTONS AND FUNCTIONS

- FAN SPEED Button**
 - Scroll through fan speeds (Auto - Low - Med - High)
- MODE Button**
 - Use + and – buttons to scroll through available operation modes (Auto / Cool / Dry / Heat / Fan)
- FUNCTION Button**
 - Scrolls through unit operations in this order:
 1. Turbo
 2. Sleep
 3. Follow Me
- SWING Button**
 - Used to stop or start louver auto swing feature (certain models)
 - Louvers oscillate up and down automatically. Press and hold the Swing button again to disable.
 - Pressing the Swing button multiple times will set the louvers at five different fixed airflow angles.
 - Press and hold Swing button for 2 seconds to activate left/right louver operation. Louvers swing left and right automatically.
- UP/DOWN Buttons**
 - Increase or decrease the indoor temperature in one degree increments (maximum 86°F, minimum 60°F).
 - NOTE** - Temperature cannot be adjusted in FAN mode.
- TIMER Button**
 - Sets unit for daily or weekly on/off operation
- COPY Button**
 - Copy schedules from one day to another
- POWER Button**
 - Turn system on and off
- CONFIRM Button**
 - Confirms each step when managing schedules
 - NOTE** - Press and hold and **Confirm** Button and the **Arrow Down** button together for 3 seconds to alternate the temperature display between the °F and °C scale.
- BACK Button**
 - Returns to the previous step
- DAY OFF/DELAY BUTTON**
 - Disable specific days/schedules of the week
 - Delete a specific event
- LOCK**
 - Press the **Function** and **Swing** buttons simultaneously to lock the Controller to prevent tampering with settings

OPTIONAL ACCESSORIES

Extension Cable for Wired Programmable Controller

- 20 ft. cable for easy low voltage connection to the indoor unit
- Extends cable to 40 ft. (12 m) length

REMOTE CONTROLLERS - OPTIONAL

WIRED PROGRAMMABLE REMOTE CONTROLLER INDICATORS (M0STAT120N-1)

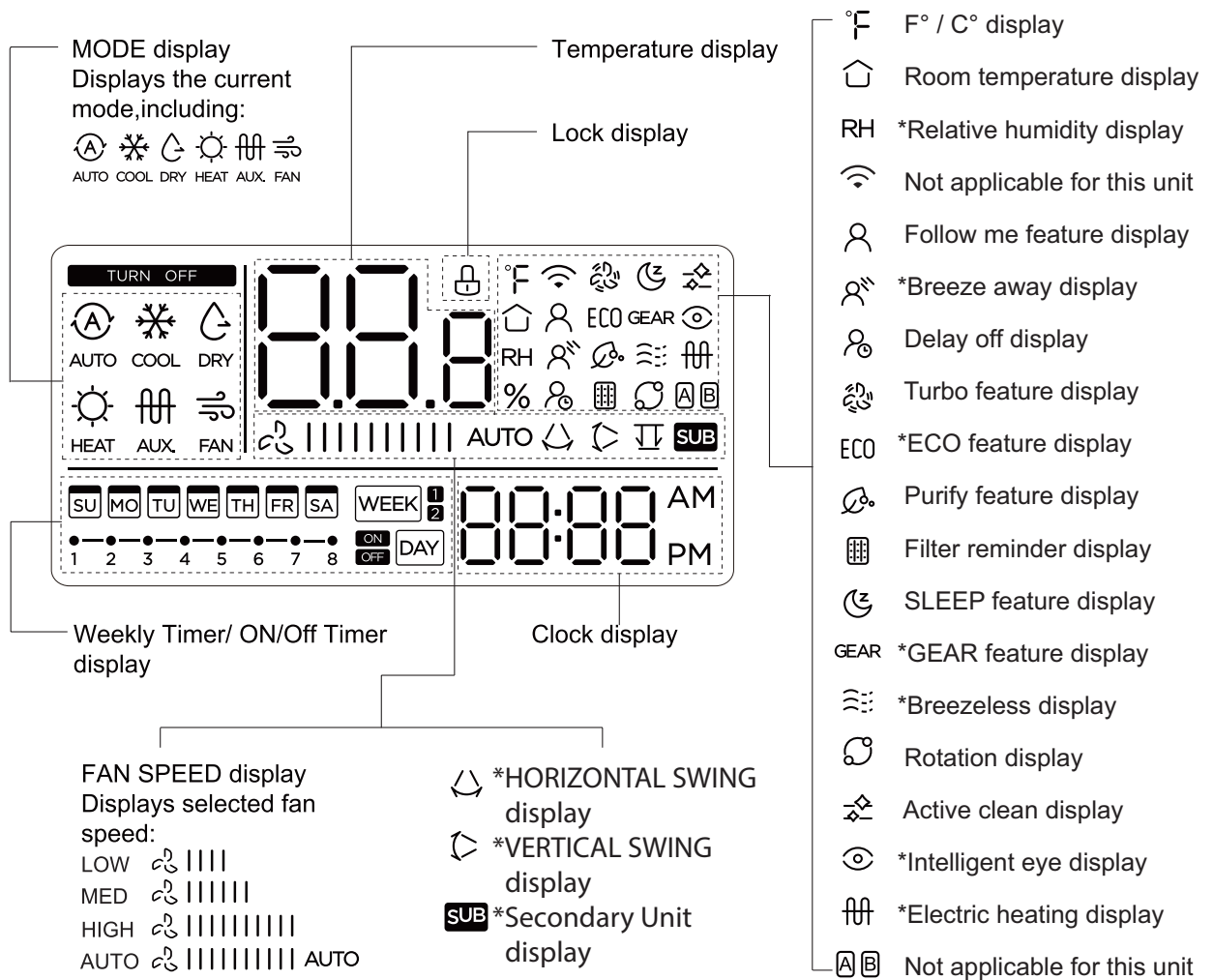

NOTE:

All icons are shown for display purposes only.
 During actual unit operation, only active icons are displayed.

**Certain Models*

SPECIFICATIONS

	Model No.	MCFB018S4	MCFA024S4	MCFA036S4	MCFA048S4
	Nominal Tons	1.5	2	3	4
Power Supply - 60 hz - 1 phase		208/230V	208/230V	208/230V	208/230V
	Rated load amps	1.65	2.2	1.5	1.8
	Output (W)	90	90	115	(2) 90
Room Temperature Range (°F)	Cooling	60 - 90	60 - 90	60 - 90	60 - 90
	Heating	32 - 86	32 - 86	32 - 86	32 - 86
	Air Volume - cfm (High/Medium/Low)	580/520/465	760/710/600	1035/915/640	1350/1120/1000
	Sound Data (dBA) - Low/Medium/High	39/43/46	42/47/51	41/48/52	45/50/55
Piping Connections - Liquid/Gas - o.d. - flare - in.		1/4 / 1/2	3/8 / 5/8	3/8 / 5/8	3/8 / 5/8
	Drain connection o.d. - in.	1	1	1	1
	Net/Shipping weights - lbs.	58 / 69	61 / 73	69 / 82	88 / 103

OPTIONAL ACCESSORIES - ORDER SEPARATELY

Description		Catalog No.				
			018	024	036	048
INDOOR UNIT						
¹ Diversitech Condensate Pumps with Reservoir	Mini-Split Pump - 4 US gallons per hour, 20 ft. lift - 230V	Y7949	•	•	•	•
	ClearVue Mini™ - 7.9 US gallons per hour, 35 ft. lift - 120-240V	Y5170	•	•	•	•
¹ Blue Diamond® Condensate Pumps with Reservoir	MicroBlue® - 1.3 US gallons per hour, 6 ft. lift - 110-230V	14T74	•	N/A		
	MaxiBlue® - 3.7 US gallons per hour, 16.5 ft. lift - 208/230V	14T69	N/A	•	•	N/A
	MegaBlue® - 13.2 US gallons per hour, 23 ft. lift - 208/230V	14T71	N/A			•
	MultiTank Kit	14T75	N/A	•	•	•
	Sensor Cable Extension - 16 ft.	14T76	•	•	•	•
Little Giant Condensate Pump Kit with Reservoir	Mini-Split Pump Kit - 2.5 US gallons per hour, 3 ft. lift - 100-240V (includes pump, reservoir, multi-size hose drain adaptor, 7 ft. detachable power cord, pump enclosure/cover, line set cover and mounting trim brackets)	Y8794	•	•	•	•
A/C Easy Tee® Condensate Cleanout		Y7947	•	•	•	•
CONTROLS						
Wired Remote Controller	M0STAT120L-1	24X02	•	•	•	•
Extension Cable for Wired Remote Controller - 20 ft.		Y8008	•	•	•	•
Wired Programmable Controller	M0STAT120N-1	24X03	•	•	•	•
Extension Cable for Wired Programmable Controller - 20 ft.	M0CTRL64Q-1	Y8738	•	•	•	•
Indoor/Outdoor Wiring Cable - 14 Gauge, 4 conductor wire, THHN, 250 ft.		Y2067	•	•	•	•

¹ Y7949 and 14T74 condensate pumps can be installed inside the indoor units. All other pumps must be installed external to the indoor unit.

AIR THROW DATA

MCFB018S4 AND MCFA024S4 - COOLING - CEILING

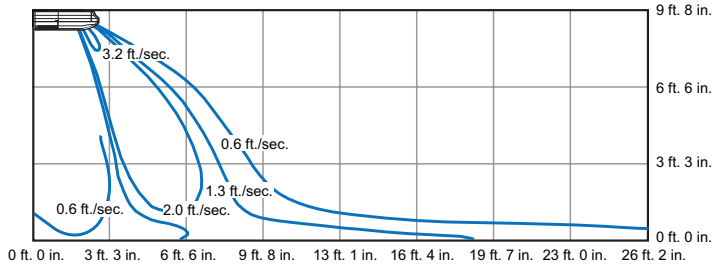

MCFB018S4 AND MCFA024S4 - HEATING - CEILING

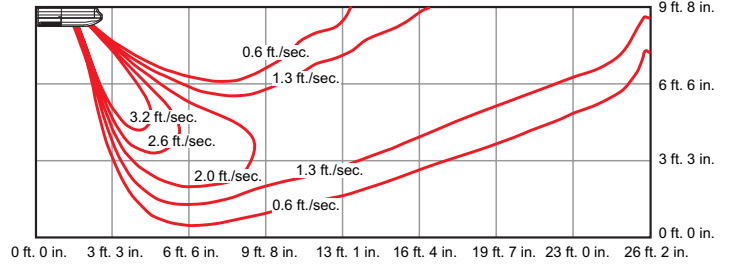

MCFB018S4 AND MCFA024S4 - COOLING - FLOOR

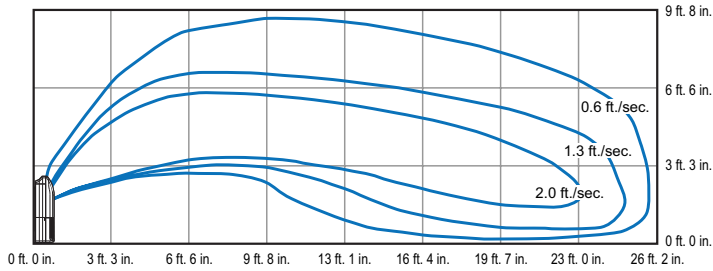

MCFB018S4 AND MCFA024S4 - HEATING - FLOOR

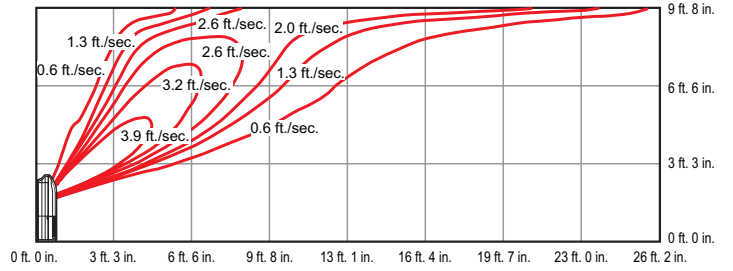

MCFA036S4 - CEILING - COOLING

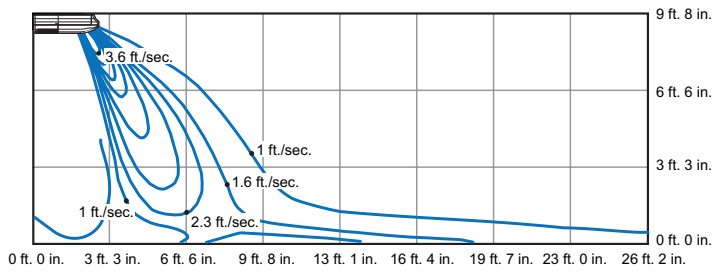

MCFA036S4 - CEILING - HEATING

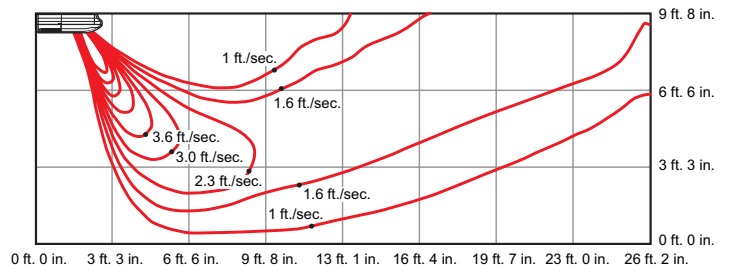

MCFA036S4 - FLOOR - COOLING

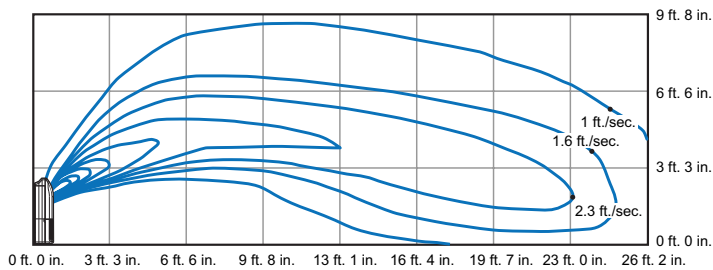

MCFA036S4 - FLOOR - HEATING

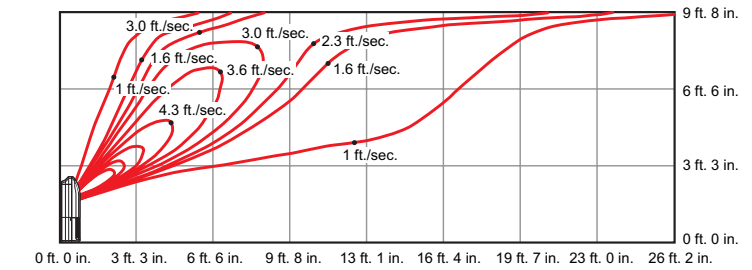

AIR THROW DATA

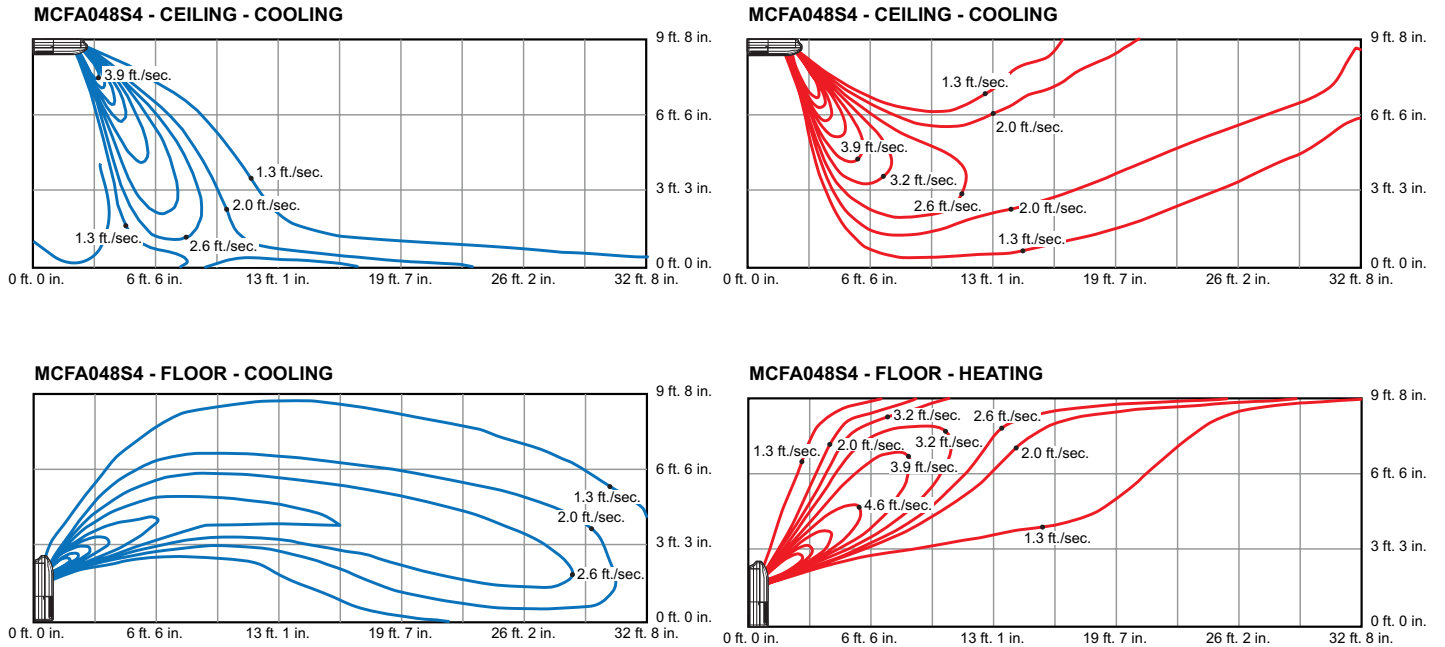

SOUND LEVELS - TEST CONDITIONS

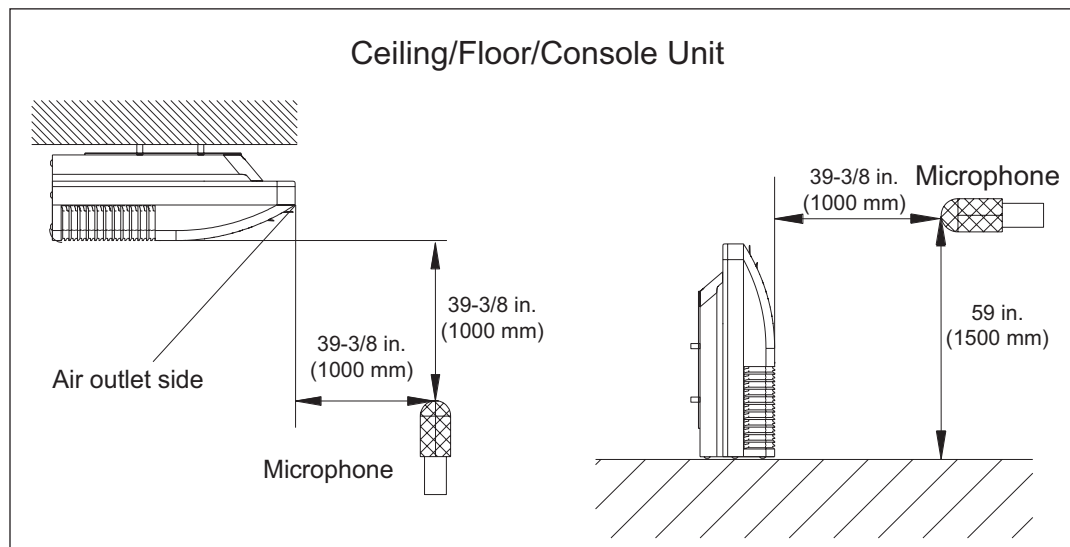

DIMENSIONS

MCFB018S4, MCFA024S4, MCFA036S4, MCFA048S4

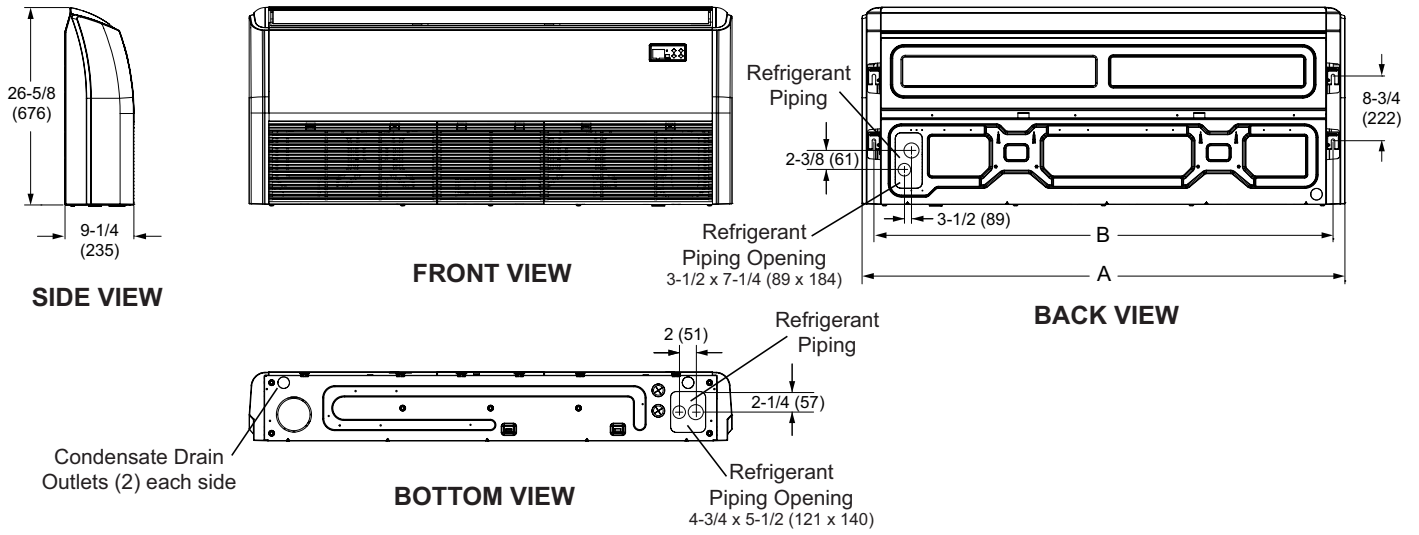

Model No.	A		B	
	in.	mm	in.	mm
018	42	1067	37	940
024	42-1/8	1070	39	991
036	50-5/8	1286	47-3/8	1203
048	65	1651	61-3/4	1568

INSTALLATION CLEARANCES

CEILING APPLICATIONS

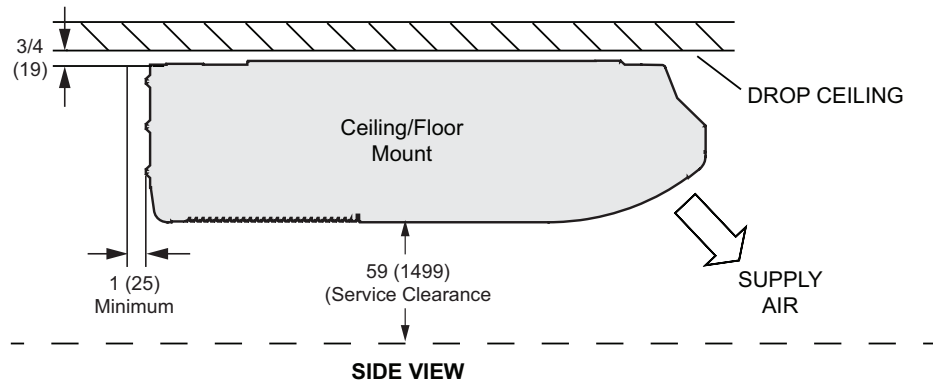

CEILING AND FLOOR APPLICATIONS

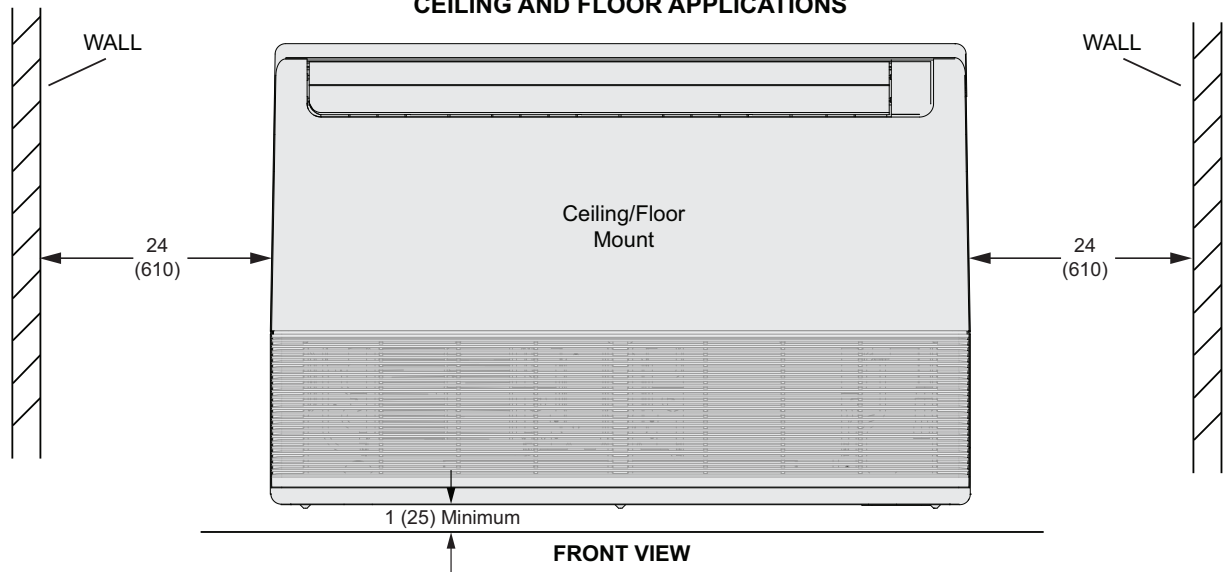

FLOOR APPLICATIONS

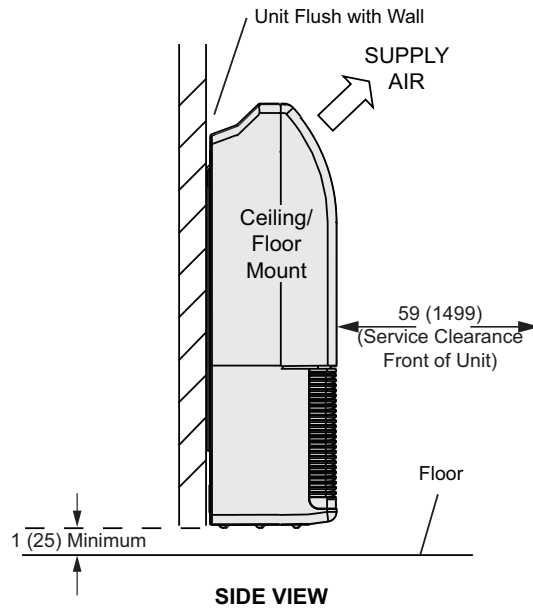

REVISIONS

Sections	Description of Change
Approvals and Warranty	Updated Warranty statement.



HRAI
✓ MEMBER COMPANY



Visit us at www.Lennox.com

For the latest technical information, www.LennoxPros.com

Contact us at 1-800-9-LENNOX

NOTE - Due to Lennox' ongoing commitment to quality, Specifications, Ratings and Dimensions subject to change without notice and without incurring liability. Improper installation, adjustment, alteration, service or maintenance can cause property damage or personal injury. Installation and service must be performed by a qualified installer and servicing agency.

©2024 Lennox Industries, Inc.