

**AA BB CC DD EE FF**

**01**

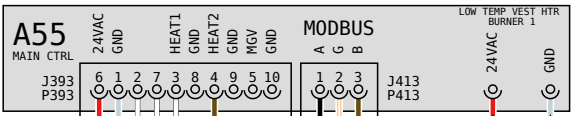

**02**

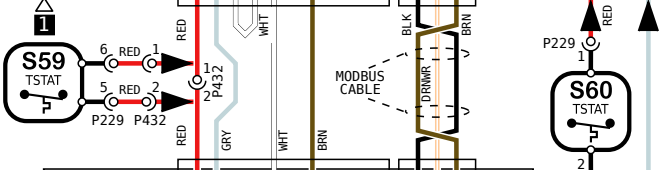

**03**

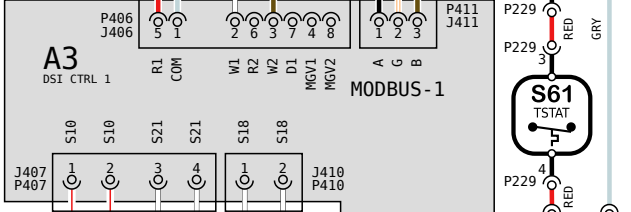

**04**

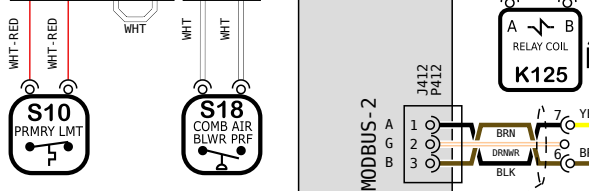

**05**

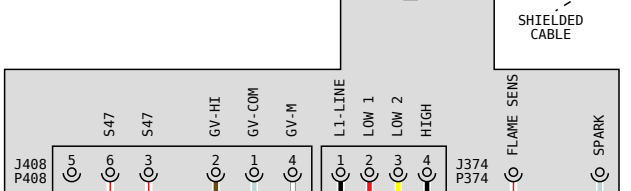

**06**

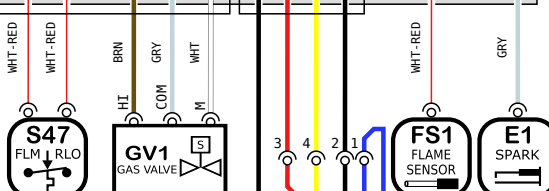

**07**

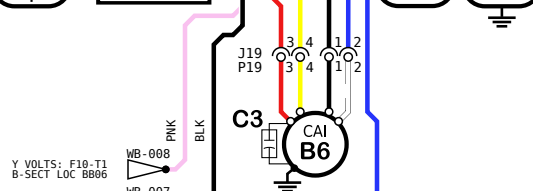

**08**

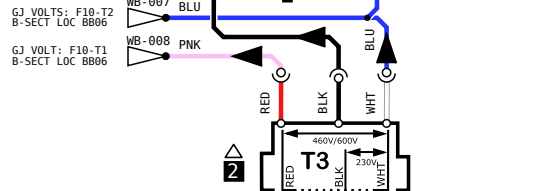

**09**

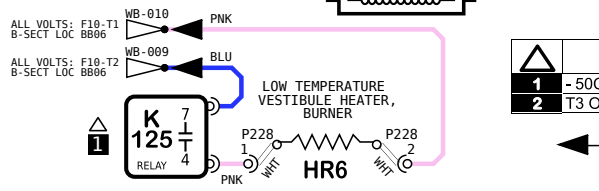

**10**

Model: LG - 036H - 072H  
Input Heat Capacity 65k - 150k BtuH  
Voltage: All Voltages  
Supersedes: XXXXXX-XX Form No: 538532-01 Rev: 000

LOCATION	COMPONENT DESCRIPTION
AA02-05	A3 CONTROL BOARD, DSI BURNER
AA01	A55 CONTROL BOARD, MAIN
DD04	B3 MOTOR, INDOOR BLOWER
CC07	B6 MOTOR, CAI MOTOR
DD08	B6 MOTOR, CAI MOTOR LP CONVERSION
CC07	C3 CAPACITOR, CAI MOTOR
DD08	C3 CAPACITOR, CAI MOTOR LP CONVERSION
DD06	E1 IGNITER, SPARK, BURNER
CC08	FS1 SENSOR, FLAME, BURNER
BB08	GV1 VALVE, GAS, BURNER
CC09	HR6 HEATER, -50C LOW TEMP VEST, BURNER
DD04	K125 RELAY, LOW TEMP VEST HEATER, BURNER
BB09	K125 RELAY, LOW TEMP VEST HEATER, BURNER
AA04	S10 LIMIT, PRIMARY, BURNER
BB04	S18 SWITCH, COMB AIR BLWR PROOF, BURNER
AA06	S47 SWITCH, FLAME ROLLOUT, BURNER
AA02	S59 TSTAT, OPEN -20F, CLOSE 10F, BURNER
CC02	S60 TSTAT, OPEN 20F, CLOSE -10F, BURNER
CC03	S61 TSTAT, OPEN 50F, CLOSE 20F, BURNER
CC08	T3 TRANSFORMER, CAB

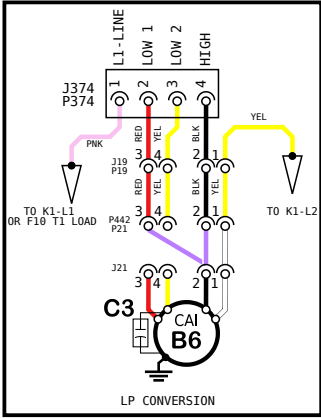
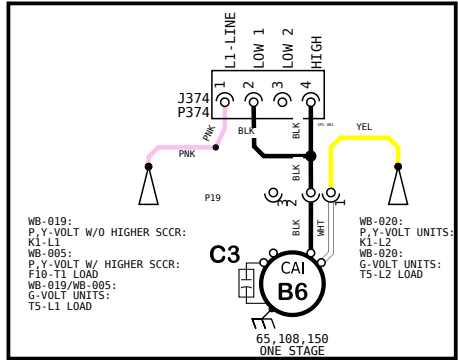

NOTES	
1	- 50C LOW TEMPERATURE VESTIBULE HEATER - OPTIONAL
2	T3 ONLY USED IN G AND J VOLT UNITS

← DENOTES OPTIONAL COMPONENTS AND WIRING

© 2019

HEATING	COOLING	COOLING	ACCS	ACCS
SECTION A	SECTION B	SECTION B3/5	SECTION C	SECTION D

WIRING DIAGRAM FLOW

7x10  
CUT  
SIZE

REV	EC NO.	DATE	BY	APVD	REVISION NOTE
000	CN-012122A	04/25/2024	AXL	AAH	ORIGINATED AT PD&R CARROLLTON, TX

**AA BB CC DD EE FF**

**01**

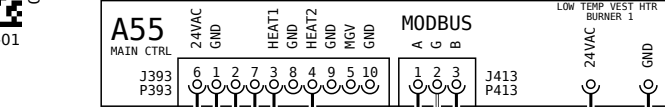

**02**

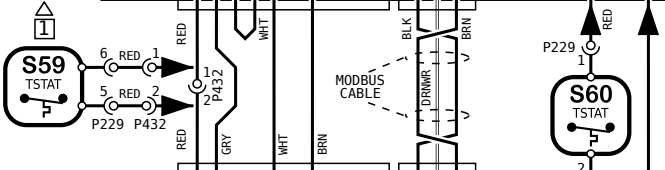

**03**

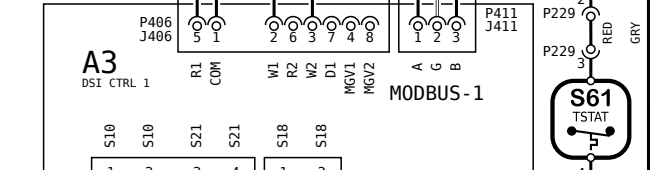

**04**

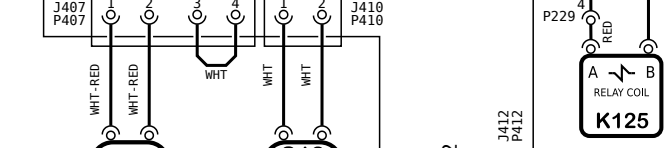

**05**

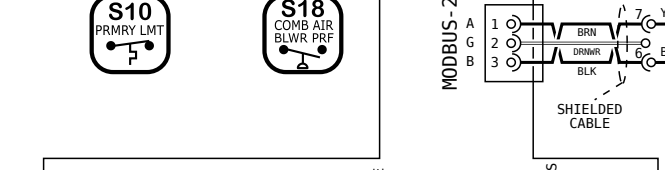

**06**

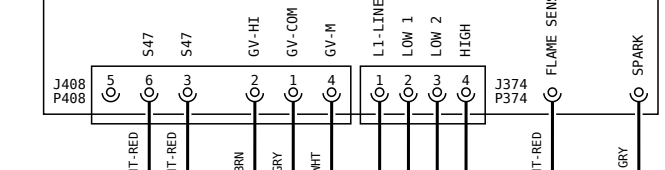

**07**

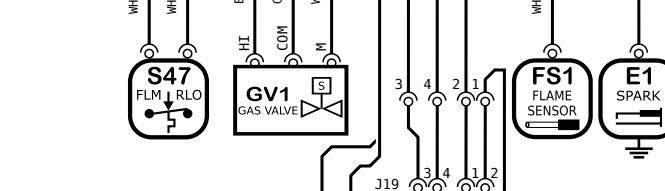

**08**

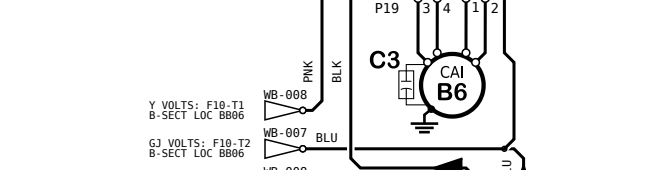

**09**

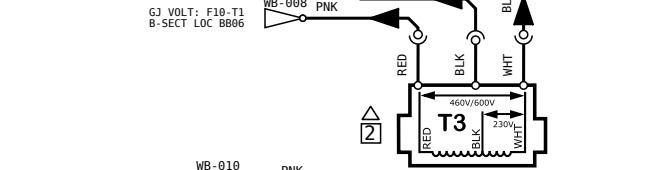

**10**

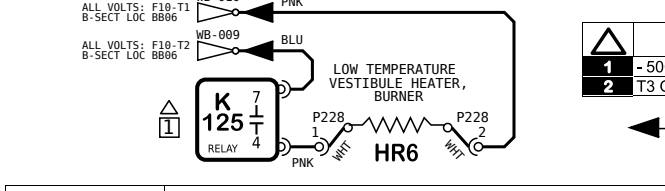

KEY LIST	
LOCATION	COMPONENT DESCRIPTION
AA02-05	A3 CONTROL BOARD, DSI BURNER
AA01	A55 CONTROL BOARD, MAIN
DD04	B3 MOTOR, INDOOR BLOWER
CC07	B6 MOTOR, CAI MOTOR
DD08	B6 MOTOR, CAI MOTOR LP CONVERSION
CC07	C3 CAPACITOR, CAI MOTOR
DD08	C3 CAPACITOR, CAI MOTOR LP CONVERSION
DD06	E1 IGNITER, SPARK, BURNER
CC08	FS1 SENSOR, FLAME, BURNER
BB08	GV1 VALVE, GAS, BURNER
CC09	HR6 HEATER, -50C LOW TEMP VEST. BURNER
DD04	K125 RELAY, LOW TEMP VEST HEATER, BURNER
BB09	K125 RELAY, LOW TEMP VEST HEATER, BURNER
AA04	S10 LIMIT, PRIMARY, BURNER
BB04	S18 SWITCH, COMB AIR BLWR PROOF, BURNER
AA06	S47 SWITCH, FLAME ROLLOUT, BURNER
AA02	S59 TSTAT, OPEN -20F, CLOSE 10F, BURNER
CC02	S60 TSTAT, OPEN 20F, CLOSE -10F, BURNER
CC03	S61 TSTAT, OPEN 50F, CLOSE 20F, BURNER
CC08	T3 TRANSFORMER, CAB

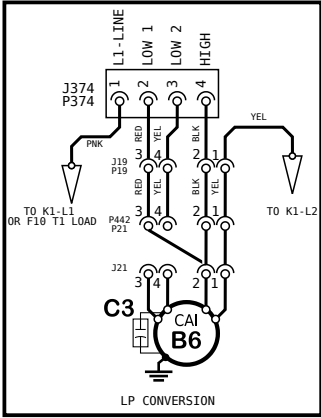
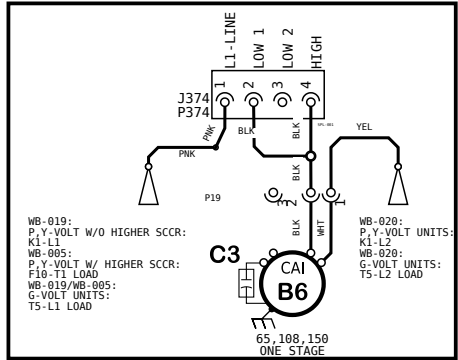

NOTES	
1	- 50C LOW TEMPERATURE VESTIBULE HEATER - OPTIONAL
2	T3 ONLY USED IN G AND J VOLT UNITS

← DENOTES OPTIONAL COMPONENTS AND WIRING

© 2019

Model:	LG - 036H - 072H
Voltage:	All Voltages
Supersedes:	XXXXXX-XX Form No: 538532-01 Rev: 000

HEATING	COOLING	COOLING	ACCS	ACCS
SECTION A	SECTION B	SECTION B3/5	SECTION C	SECTION D

WIRING DIAGRAM FLOW

7x10  
CUT  
SIZE

REV	EC NO.	DATE	BY	APVD	REVISION NOTE
000	CN-012122A	04/25/2024	AXL	AAH	ORIGINATED AT PD&R CARROLLTON, TX